

## DUAL DIFFERENTIAL INPUT OPERATIONAL AMPLIFIERS

Utilizing the circuit designs perfected for recently introduced Quad Operational Amplifiers, these dual operational amplifiers feature 1) low power drain 2) a common mode input voltage range extending to ground/ $V_{EE}$ , 3) Single Supply or Split Supply operation and 4) pin outs compatible with the popular MC1558 dual operational amplifier. The LM358 Series is equivalent to one half of an LM324

These amplifiers have several distinct advantages over standard operational amplifier types in single supply

### FEATURES

- Short circuit protected outputs
- True differential input stage
- Single supply operation : 3.0 V to 32 Volts
- Low input bias currents
- Internally compensated
- Common mode range extends to negative supply
- Single and split supply operation
- Similar performance to the popular MC1558

### MAXIMUM RATINGS ( $T_A = +25^\circ\text{C}$ , unless otherwise

Rating	Symbol	LM358	Unit
Power Supply Voltage Single Supply Split Supplies	$V_{CC}$ $V_{CC}, V_{EE}$	32 $\pm 16$	Vdc
Input Differential Voltage Range (1)	$V_{IDR}$	$\pm 32$	Vdc
Input Common Mode Voltage Range (2)	$V_{ICR}$	-0.3 to 32	Vdc
Input forward current (3) ( $V_I \leq 0.3V$ )	$I_{IF}$	50	mA
Output Short Circuit Duration	$t_S$	Continuous	
Junction Temperature Plastic Packages	$T_J$	150	$^\circ\text{C}$
Storage Temperature Range Plastic Packages	$T_{stg}$	-55 to +125	$^\circ\text{C}$
Operating Ambient Temperature Range LM358	$T_A$	0 to +70	$^\circ\text{C}$

NOTE : 1. Split Power Supplies.

2. For supply. Voltages less than 32V for the LM358 the absolute maximum input voltage is equal to the supply voltage.

applications . They can operate at supply voltages as low as 3.0 Volts or as high as 32 Volts with quiescent currents about one fifth of those associated with the MC1741 (on a per amplifier basis). The common mode input range includes the negative supply, thereby eliminating the necessity for external biasing components in many applications.

The output voltage range also includes the negative power supply voltage.

### ORDERING INFORMATION

Device	Temperature Range	Package
LM358CS	0 $^\circ\text{C}$ to +70 $^\circ\text{C}$	SO-8
LM358CD	0 $^\circ\text{C}$ to +70 $^\circ\text{C}$	Plastic DIP

### PIN ARRANGEMENT

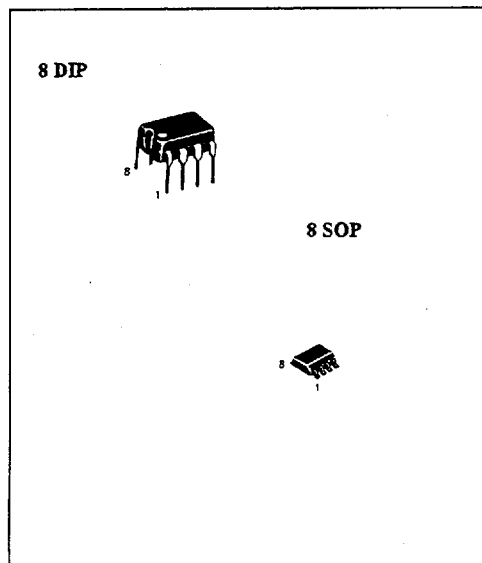

3. This input current will only exist when the voltage is negative at any of the input teads. Normal output states will reestablish when the input voltage returns to a voltage greater than -0.3V.

## ELECTRICAL CHARACTERISTICS ( $T_A = +25^\circ\text{C}$ , $V_{CC} = 5\text{V}$ unless otherwise noted).

Characteristics	Symbol	LM358			Unit
		Min	Typ	Max	
Input Offset Voltage $V_{CC} = 5.0\text{V to } 30\text{V}$ $V_{IC} = 0\text{V to } V_{CC} - 1.7\text{V}$ , $V_O = 1.4\text{V}$ , $R_S = 0\Omega$ $T_A = 25^\circ\text{C}$ $T_A = 70^\circ\text{C to } 0^\circ\text{C}$	$V_{IO}$	-	2.0	7.0	mV
		-	-	9.0	
Average Temperature Coefficient of Input Offset Voltage $T_A = 70^\circ\text{C to } 0^\circ\text{C}$	$\Delta I_{IO} / \Delta T$	-	7.0	-	$\mu\text{V}/^\circ\text{C}$
Input Offset Current $T_A = 70^\circ\text{C to } 0^\circ\text{C}$	$I_{IO}$	-	5.0	50	nA
		-	-	150	
Average Temperature Coefficient of input Offset Current $T_A = 70^\circ\text{C to } 0^\circ\text{C}$	$\Delta I_{IO} / \Delta T$	-	10	-	$\text{pA}/^\circ\text{C}$
Input Bias Current $T_A = 70^\circ\text{C to } 0^\circ\text{C}$	$I_{IB}$	-	45	-250	$\mu\text{A}$
			50	-500	
Input Common-Mode Voltage Range (Note 1) $V_{CC} = 30\text{V}$ $V_{CC} = 30\text{V}$ , ( $T_A = 70^\circ\text{C to } 0^\circ\text{C}$ )	$V_{ICR}$	0	-	28.3	V
		0	-	28	
Differential input Voltage Range	$V_{IDR}$	-	-	$V_{CC}$	V
Large Signal Open-Loop Voltage Gain $R_L = 2.0\text{k}\Omega$ , $V_{CC} = 15\text{V}$ , For Large $V_O$ Swing, $T_A = 70^\circ\text{C to } 0^\circ\text{C}$	$A_{VOL}$	25	100	-	V/mV
		15	-	-	
Channel Separation 1.0 KHz to 20kHz, Input Referenced	-	-	-120	-	dB
Common Mode Rejection Ratio $R_S \leq 10\text{k}\Omega$	CMRR	65	70	-	dB
Power Supply Rejection Ratio	PSRR	65	100	-	dB
Output Voltage Range $R_L = 2\text{k}\Omega$	$V_{OR}$	0	-	3.3	V
Output Voltage - High Limit, ( $T_A = 70^\circ\text{C to } 0^\circ\text{C}$ ) $V_{CC} = 30\text{V}$ , $R_L = 2\text{k}\Omega$ $V_{CC} = 30\text{V}$ , $R_L = 10\text{k}\Omega$	$V_{OH}$	26	-	-	V
		27	28	-	
Output Voltage - Low Limit, ( $T_A = 70^\circ\text{C to } 0^\circ\text{C}$ ) $V_{CC} = 5.0\text{V}$ , $R_L = 10\text{k}\Omega$	$V_{OL}$	-	5.0	20	mV
Output Source Current $V_{ID} = +1.0\text{V}$ , $V_{CC} = 15\text{V}$	$I_{OS}$	20	40	-	mA
Output Sink Current $V_{ID} = -1.0\text{V}$ , $V_{CC} = 15\text{V}$ $V_{ID} = -1.0\text{V}$ , $V_O = 200\text{mV}$	$I_{OS}$	10	20	-	mA
		12	50	-	$\mu\text{A}$
Output Short Circuit to Ground (Note 2)	$I_{SC}$	-	40	60	mA
Power Supply Current, ( $T_A = 0^\circ\text{C to } 70^\circ\text{C}$ ) $V_{CC} = 30\text{V}$ , $V_O = 0\text{V}$ , $R_L = \infty$ $V_{CC} = 5.0\text{V}$ , $V_O = 0\text{V}$ , $R_L = \infty$	$I_{CC}$	-	1.5	3.0	mA
		-	0.7	1.2	

Notes : 1. The input common mode voltage or either input signal voltage should not be allowed to go negative by more than 0.3 V. The upper end of the common mode voltage range is  $V_{CC} - 1.7\text{V}$ , but either or both inputs can go to  $+32\text{V}$ .

2. Short circuits from the output to  $V_{CC}$  can cause excessive heating and eventual destruction. Destructive dissipation can result from simultaneous shorts on all amplifiers.

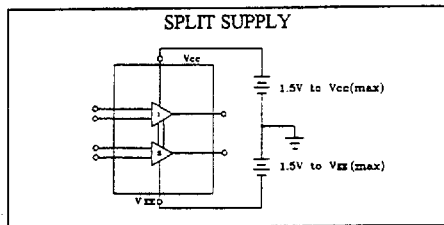
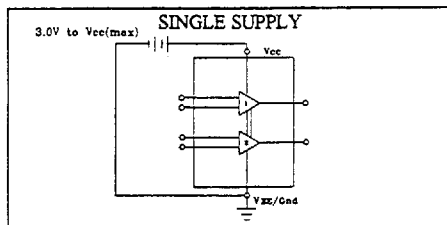

## REPRESENTATIVE CIRCUIT SCHEMATIC

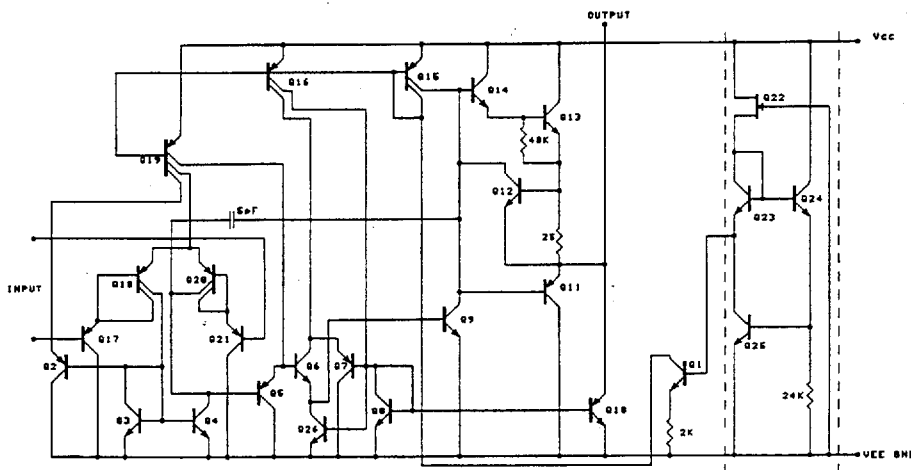

## CIRCUIT DESCRIPTION

The LM358 is made using two internally compensated, two-stage operational amplifiers. The first stage of each consists of differential input devices Q20 and Q18 with input buffer transistors Q21 and Q17 and the differential to single ended converter Q3 and Q4. The first stage performs not only the first stage gain function but also performs the level shifting and transconductance reduction functions. By reducing the transconductance a smaller compensation capacitor (only 5 pF) can be employed, thus saving chip area. The transconductance reduction is accomplished by splitting the collectors of Q20 and Q18

. Another feature of this input stage is that the input common-mode range can include the negative supply or ground, in single supply operation, without saturating either the input devices or the differential to single-ended converter. The second stage consists of a standard current source load amplifier stage.

Each amplifier is biased from an internal voltage regulator which has a low temperature coefficient thus giving each amplifier good temperature characteristics as well as excellent power supply rejection.

## APPLICATIONS INFORMATION

### FIGURE 1 - FUNCTION GENERATOR

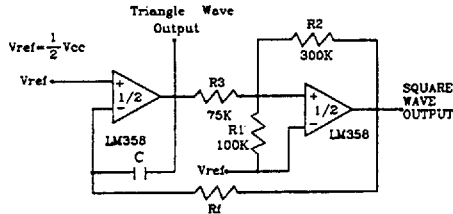

$$f = \frac{R1+RC}{4CR_1R_1} \text{ if } R3 = \frac{R2 \cdot R1}{R2+R1}$$

### FIGURE 2 - MULTIPLE FEEDBACK BANDPASSFILTER

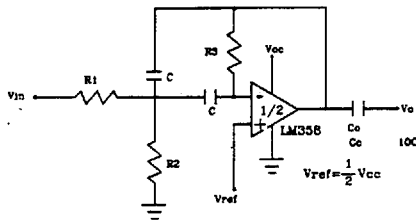

Given  $f_0$  = center frequency  
 $A(f_0)$  = gain at center frequency

Choose value  $f_0, C$

Then:

$$R3 = \frac{Q}{\pi f_0 C}$$

$$R1 = \frac{R3}{2A(f_0)}$$

$$R2 = \frac{R1R3}{4Q^2R1 - R3}$$

LARGE SIGNAL VOLTAGE  
 FOLLOWER RESPONSE

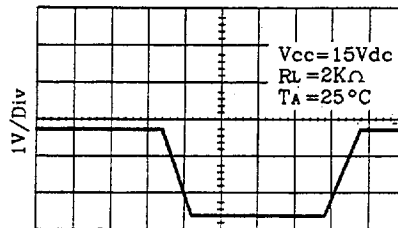

For less than 10% error from, operational amplifier.

$$\frac{Q_0 f_0}{BW} < 0.1 \text{ where } f_0 \text{ and } BW \text{ are Expressed with voltage in Hz.}$$

BW

If source impedance varies, filter may be preceded with voltage follower buffer to stabilize filter parameters.