

The Mars Series of quarter-brick DC/DC converters offers high current performance with high efficiency at low cost.

GAMW1V240 Features

48V Input

1.2VDC, 40A Output

High Efficiency

83% at 1.2V, 40A

86% at 1.2V, 20A

The Mars CoolConverter™ is the most cost-effective 100W quarter-brick on the market.

- Industry Standard Pinout and Footprint
- No Heat Sink Required
- Very Low Common-mode Noise for a Commercial DC/DC Converter
- Two-stage Input Filter
- Constant Switching Frequency
- Remote Sense
- Single Board Design
- Very Low Parts Count
- Optional Baseplate or Low Profile Heatsink for Improved Thermal Performance
- Header with M3 Metal Inserts for Mechanical Connection to PCB
- Two Year Warranty

CONTROL FUNCTIONS

- Uses Patented Power Supply Control and Architecture
- Microprocessor Controlled
- Primary-side Enable, Choice of Logic

PROTECTION FEATURES

- Over Temperature Protection
- Over Voltage Protection
- Over Current Protection
- Over/Under Input Voltage Protection

TYPICAL CHARACTERISTICS

- Output Setpoint Accuracy: $\pm 1\%$
- Load Regulation: $\pm 0.2\%$
- Line Regulation: $\pm 0.2\%$
- Regulation over Line, Load, and Temperature: $\pm 2\%$
- Low Output Ripple
- Output Trim



Certified to ISO 9001:2000

GENERAL SPECIFICATIONS

$V_{IN} = 48V_{DC}$, $T_A @ 25^\circ C$, 300 LFM Airflow, $V_{OUT} = 1.2V_{DC}$, $I_{OUT} = \text{Full Load unless otherwise noted.}$

Available output power depends on ambient temperature and good thermal management. (See application graphs for limits.)

Input Characteristics				
Parameter	Min	Typ	Max	Units
Operating Input Voltage	36	48	75	V_{DC}
Input Current			1.8	A
Input Capacitance		3		μF
Input Hysteresis, Low Line		2		V_{DC}
Output Characteristics				
Regulation Over Line, Load & Temperature	1.176		1.224	V
Voltage Ripple			20	mV _{RMS}
Voltage Ripple, 20MHz BW			50	mV _{P-P}
Current Range	0		40	A
Current Limit Inception	41.2		56	% I_o MAX
Short Circuit Current, Peak ¹			60	A
Output Transient Response, 50% to 75% load change, 1A/ μsec^2			24	% V_{OUT}
Settling Time to $\pm 1\%$			300	μS
Turn-on Time to 98% V_{nom}			25	mS
Output Overshoot at Turn-on		0		% V_{OUT}
Trim Range	70		110	% V_{OUT}
Overvoltage Protection, Latching		130		% V_{OUT}
Isolation				
Isolation Test Voltage, Input/Output (Basic)	2250			V_{DC}
Isolation Resistance	10			$M\Omega$
Features				
Overtemperature Protection, Thermal Sensor, Latching ³			110	$^\circ C$
Switching Frequency, Fixed		250		kHz

Notes:

1. During short circuit, converter will shut down and attempt to restart once per second. The average current during this condition will be very low and the device can be safely left in this condition continuously.
2. Limited by output energy storage. For improved performance see Tuned (T) model information.
3. PCB less than 130 $^\circ C$

GENERAL SPECIFICATIONS

Operating Temperature	-40 $^\circ C$ to +100 $^\circ C$	
Storage Temperature	-55 $^\circ C$ to +125 $^\circ C$	
Relative Humidity	10% to 95% RH, Non-condensing	
Vibration	2 to 9Hz, 3mm disp., 9 to 200Hz, 1g	
Material Flammability	UL V-0	
Weight	35 grams	
MTBF	Telcordia (Bellcore)	TBD

APPROVALS AND STANDARDS

UL and c-UL Recognized Component, TUV**, UL60950, CSA 22.2 No. 950, IEC/EN 60950
EMC Characteristics:
Designed to meet emission and immunity requirements per EN55022, CISPR 22, Class B, and CISPR 24.

** An external fuse shall be used to comply with the requirements.

APPLICATION NOTES

COOLCONVERTER™

Galaxy's proprietary CoolConverter™ provides:

- Patented single-stage power conversion architecture, control, and magnetic design allow unprecedented power density and efficiency in an isolated power supply.
- An advanced microcontroller reduces parts count while adding features, performance, and flexibility in the design.
- Low common-mode noise as a result of lower capacitance in the transformer from balanced winding design.

PROTECTION AND CONTROL

Valid Input Voltage Range:

The converter measures the input voltage and will not allow operation outside of the input voltage specification. As shown by the graphs, hysteresis is added to both the high and low voltage to prevent the converter from turning on and off repeatedly when the voltage is held near either voltage extreme. At low line this assures the maximum input current is not exceeded; at high line this assures the semiconductor devices in the converter are not damaged by excessive voltage stress.

ON/OFF Logic Option:

The ON/OFF control logic can be either Negative (standard) or Positive to enable the converter. For Negative logic the ON/OFF pin is brought to below 1.0V with respect to the -INPUT pin to enable the converter. The pull down must be able to sink 100 μ A. For Positive logic the ON/OFF pin is brought to greater than 4.0V with respect to the -INPUT pin and be limited to less than 10V. To request the Positive logic version, add the suffix (P) to the standard part number. The ON/OFF pin has a built-in pull up resistor of approximately 100k Ω to +5V.

Undervoltage Hysteresis

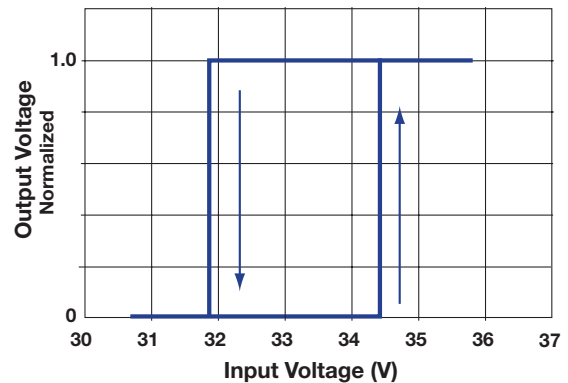

Overvoltage Hysteresis

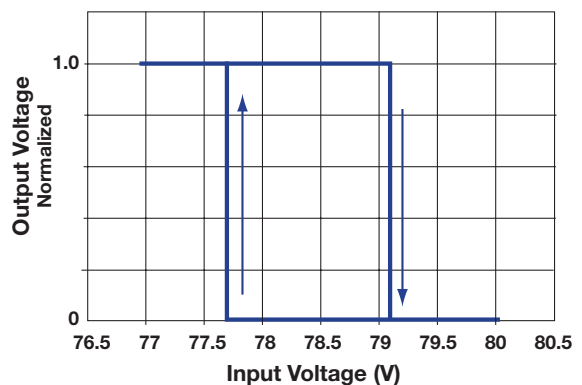

APPLICATION NOTES

Output Over Voltage Protection:

The output voltage is constantly monitored by the microprocessor with a redundant secondary-side measurement circuit that both shuts down the duty cycle and triggers the microprocessor to shut down. If the output voltage exceeds the over-voltage specification, the microprocessor will latch the converter off. To turn the converter on requires either cycling the ON/OFF pin or power to the converter. This advanced feature prevents the converter from damaging the load if there is a converter failure or application error. If non-latching is required, consult factory.

Thermal Shutdown:

The printed circuit board temperature is measured using a semiconductor sensor. If the maximum rated temperature is exceeded, the converter is latched off. To re-enable the converter requires cycling the ON/OFF pin or power to the converter. If non-latching is required, consult factory.

Control Options:

As the behavior of the circuit is determined by firmware in the microcontroller, specific customer requirements such as

- non-latching thermal protection
- custom valid input voltage range
- controlled delay from initiating an ON/OFF signal for power sequencing

can be accomplished with no change to hardware.

The standard behavior was chosen based on system design experience but we understand that customers often have their own requirements.

Please consult Galaxy Power for your special needs.

Remote Sense:

The output voltage is regulated at the point where the sense pins connect to the power output pins. Total sense compensation should not exceed 0.4V or 10% of V_{out} , whichever is greater.

Safety:

An external input fuse must always be used to meet these safety requirements.

External Output Trimming

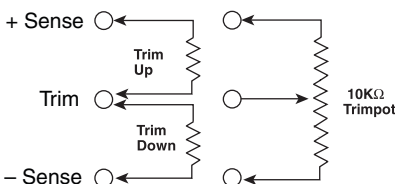

Trim:

To trim the output voltage higher, connect the required trim resistor from the Trim pin to the + Sense pin. To trim the output voltage lower, connect the required trim resistor from the Trim pin to the -Sense pin. The Trim-down equation applies to all Voltages.

Trim-up

$$R_{\text{TRIM-UP}} = \left\{ \frac{1.2(100 + \Delta\%)}{0.62\Delta\%} - \frac{(100 + 2\Delta\%)}{\Delta\%} \right\} 5.11 \text{ k}\Omega$$

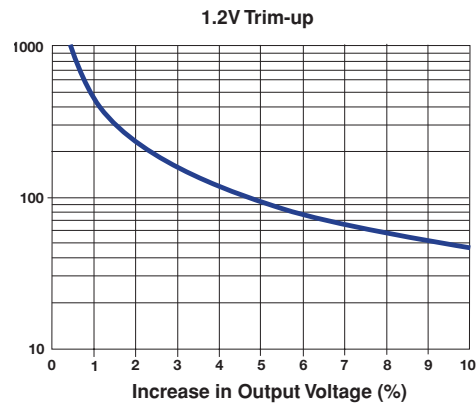

Trim-down

$$R_{\text{TRIM-DOWN}} = \left\{ \frac{100}{\Delta\%} - 2 \right\} 5.11 \text{ k}\Omega$$

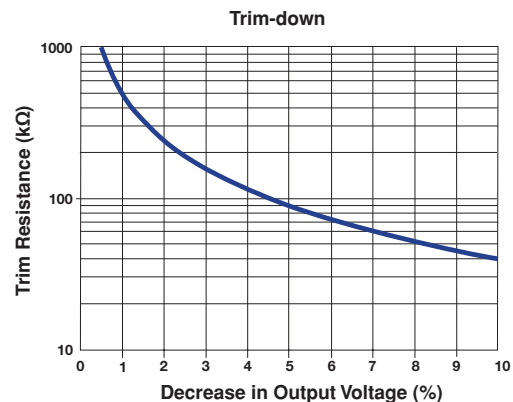

GAMW1V240 OPERATION

Efficiency

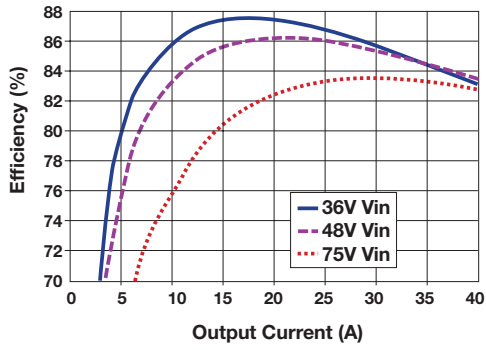

Power Dissipation

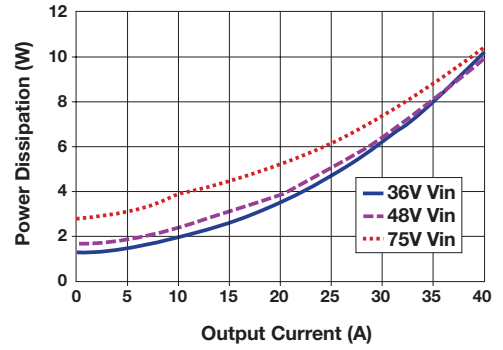

Start Up

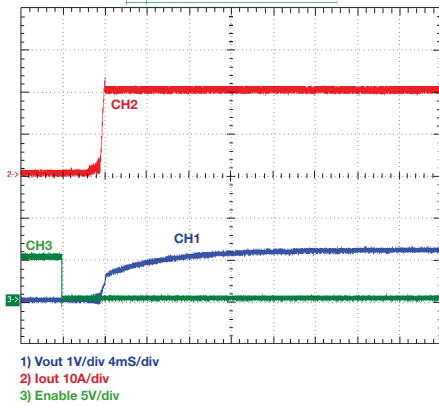

Voltage Ripple

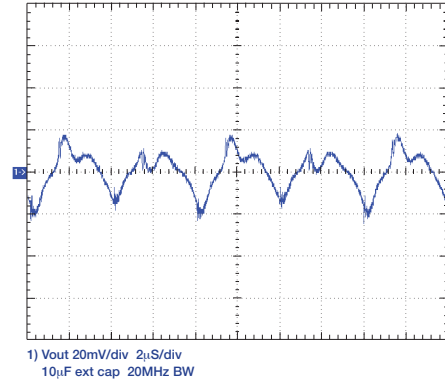

Transient Response

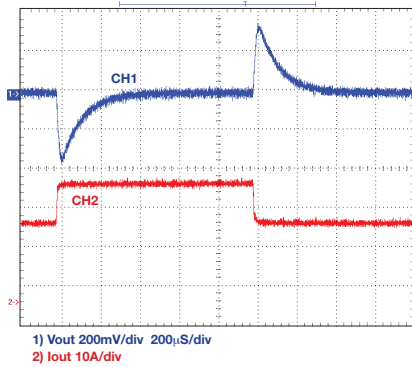

Line/Load Regulation

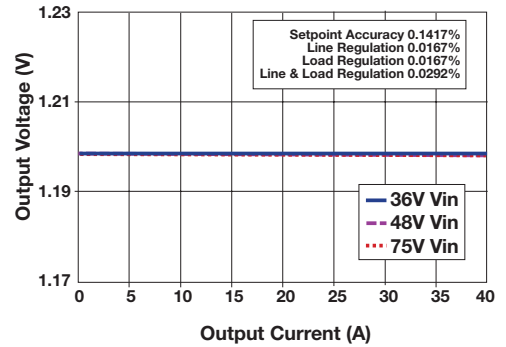

GAMW1V240 OPERATION

Back Bias

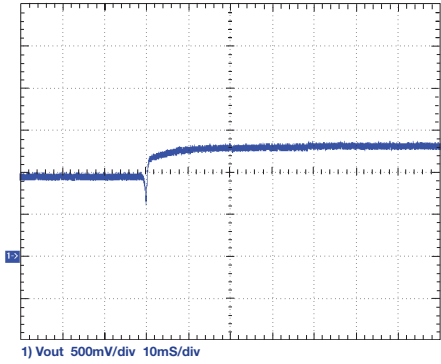

Over-current Protection

Note: Over-current protection is blip-mode (aka hiccup).

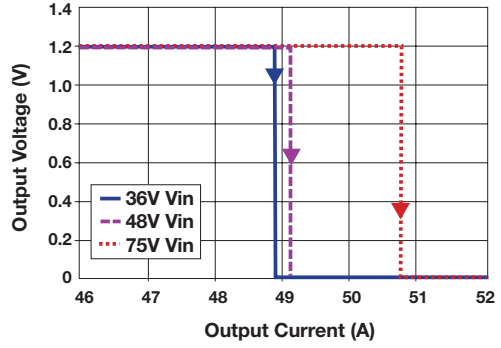

Thermal Derating Crosswise Airflow

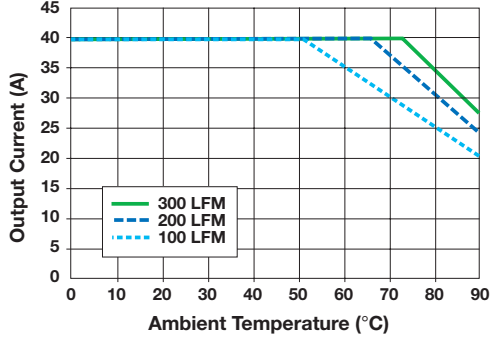

Thermal Derating Lengthwise Airflow

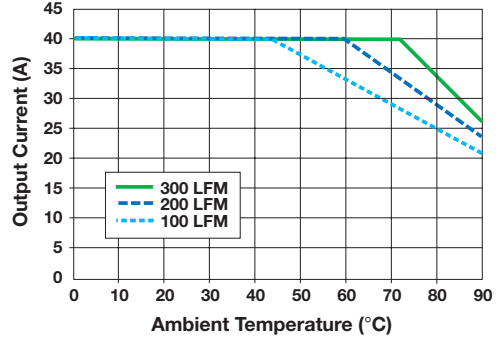

Over Voltage Protection

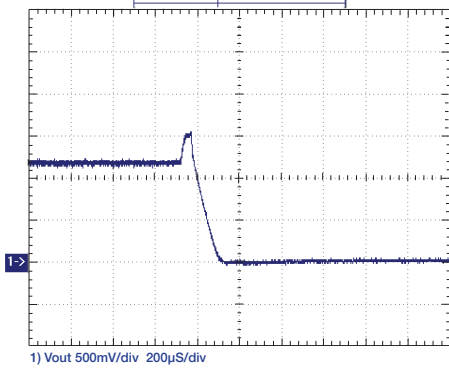

PACKAGE DETAIL

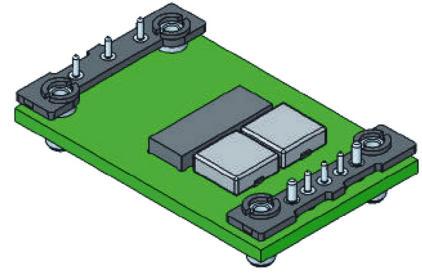
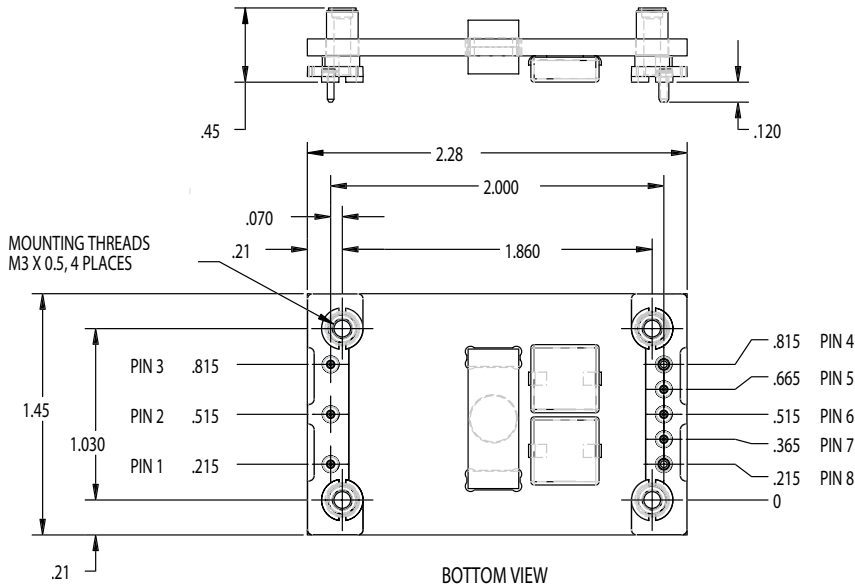

Pin Configuration (Bottom View)

Pin	Function	Pin Dia. (in.)
1	+ Input	0.040
2	On/Off	0.040
3	- Input	0.040
4	- Output	0.060
5	- Sense	0.040
6	Trim	0.040
7	+ Sense	0.040
8	+ Output	0.060

Notes:

- Mechanical tolerances:
 $x.xxx \text{ in.} = \pm 0.005 \text{ in.}$
 $x.xx \text{ in.} = \pm 0.01 \text{ in.}$
- Pin material: brass with tin/lead plating over nickel
- Workmanship: Meets or exceeds IPC-A-610B Class II
- "A" = 0.040" dia. pins
- "B" = 0.060" dia. pins
- Min. screw length for heatsink attachment
 $= 4.5\text{mm} + \text{heatsink flange} + \text{locking hardware.}$

ORDERING INFORMATION

Standard Model Number	Input Voltage	Output Voltage	Max Current
GAMW1V240*	48V	1.2V	40A

- * Options:
 P = Positive Logic Version; High = On
 E = 0.18" Pins ($\pm .01$ ")
 M = 0.145" Pins ($\pm .01$ ")
 S = 0.12" Pins ($\pm .01$ ")
 T = Tuned model**

****T (Tuned Model) Option**

Designed for higher di/dt and ΔI applications, the transient response has been modified to take advantage of the capacitance on the customer's PCB. This unit requires a minimum load capacitance of 5600 μ F with an impedance magnitude of less than 0.005 Ω at 15kHz. It offers a minimum 3X improvement in the peak response compared to a standard unit.

Example Part No.:

(All options shown)

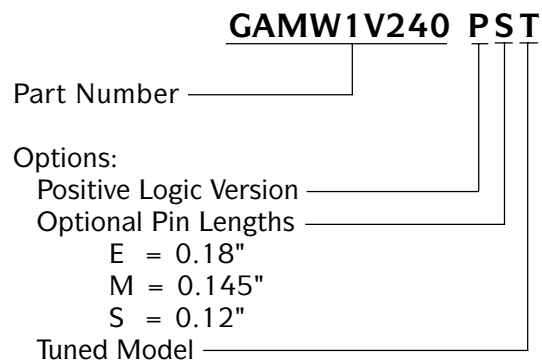

Galaxy Power Inc. warrants to the original purchaser that the products conform to this data sheet and are free from material and workmanship defects for a period of two (2) years from the date of manufacture, if this product is used within specified conditions. Galaxy Power Inc. reserves the right to make changes to the product(s) or information contained herein without notice. No liability is assumed as a result of their use or application. No rights under any patent accompany the sale of any such products or information. For additional details on this limited warranty consult the factory.