

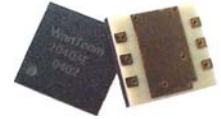

## 1.8 – 4.0 GHz LOW NOISE AMPLIFIER WHM2040AE<sup>1</sup>

WHM2040AE LNA is a low noise figure, wideband, and high linear SMT packaged amplifiers with unconditional stable design. The amplifier offers typical 1.10 dB noise figure and 26 dBm output IP<sub>3</sub> at the frequency range from 1.8 GHz to 4.0 GHz of DCS, PCS, 3G, ISM, S, and C bands. WHM2040AE LNA is most suitable for cellular base stations, wireless data communications, tower top receiver amplifiers, last-mile wireless communication systems, and wireless measurement applications.



WHM2040AE is designed to meet the rugged standards of MIL-STD-202 and MIL-STD-883.

### Key Features:

Impedance:	50 Ohm
MTBF <sup>2</sup> :	>600,000 hrs (68 Years)
LGA (land grid array) package:	6-pin
Unconditional Stable:	$k > 1$
Low Noise:	1.10 dB
Output IP <sub>3</sub> :	26.0 dBm
Gain:	26.0 dB
P <sub>1dB</sub> :	13.0 dBm
Single power supply:	50 mA @ +5V
Frequency Range:	1.8 ~ 4.0 GHz
Operating Temperature:	-40 ~ +85 °C
Return Losses:	16 dB Typical
Small size:	0.30" x 0.30" x 0.060" (7.62 mm x 7.62 mm x 1.52 mm)
Built-in Functions:	DC blocks at input and output, temperature compensation circuits, and auto DC biases.

### Absolute Maximum Ratings<sup>3</sup>:

Symbol	Parameters	Units	Absolute Maximum
V <sub>dd</sub>	DC Power Supply Voltage	V	7.0
I <sub>dd</sub>	Drain Current	mA	70
P <sub>diss</sub>	Total Power Dissipation	mW	400
P <sub>In,Max</sub>	RF Input Power	dBm	10
T <sub>ch</sub>	Channel Temperature	°C	150
T <sub>STG</sub>	Storage Temperature	°C	-65 ~ 150
T <sub>O,MAX</sub>	Maximum Operating Temperature	°C	-55 ~ 100
R <sub>th,c</sub>	Thermal Resistance	°C/W	215

<sup>1</sup> Specifications are subject to change without notice.

<sup>2</sup> MTBF: Mean Time Between Failure, Per TR-NWT-000332, ISSUE 3, SEPTEMBER, 1990, T=40°C

<sup>3</sup> Operation of this device above any one of these parameters may cause permanent damage.

**Specifications:**

a) **Table 1** Summary of the electrical specifications WHM2040AE at room temperature

Index	Testing Item	Symbol	Test Constraints	Nom (RT)	Min	Max	Unit
1	Gain	$S_{21}$	1.8 – 4.0 GHz	26	25		dB
2	Gain Variation	$\Delta G$	1.8 – 4.0 GHz	+/- 1		+/- 1.3	dB
3	Input Return Loss	$S_{11}$	1.8 – 4.0 GHz	18	14		dB
4	Output Return Loss	$S_{22}$	1.8 – 4.0 GHz	18	14		dB
5	Reverse Isolation	$S_{12}$	1.8 – 4.0 GHz	45	40		dB
6	Noise figure	NF	1.8 – 4.0 GHz	1.10		1.4	dB
7	Output Power 1dB compression Point	$P_{1dB}$	1.8 – 4.0 GHz	13	12		dBm
8	Output-Third-Order Interception point	$IP_3$	Two-Tone, $P_{out}$ +0 dBm each, 1 MHz separation	26	24		dBm
9	Current Consumption	$I_{dd}$	$V_{dd}$ = +5 V	50	45	55	mA
10	Power Supply Voltage	$V_{dd}$		+5	+4.7	+5.3	V
11	Thermal Resistance	$R_{th,c}$	Junction to case			215	°C/W
12	Operating Temperature	$T_o$			-40	+85	°C
13	Maximum Average RF Input Power	$P_{IN, MAX}$	1.8 – 4.0 GHz			10	dBm

**b) Passband Frequency Response**

As shown in **Figure 1**, the typical gain of the WHM2040AE is 26.0 dB across 1.8 to 4.0 GHz. The typical input and output return losses are 18 dB across the frequency of 1.8 to 4.0 GHz.

**Figure 2** shows the measured  $P_{1dB}$  and  $IP_3$  of the WHM2040AE. The typical  $P_{1dB}$  and  $IP_3$  are 13.0 dBm and 26.0 dBm in the frequency range of 1.8 to 4.0 GHz, respectively.

**Figure 3** illustrates the measured noise figure performance at full temperature. The measured results include the test fixture loss of approximately 0.10 dB. The noise figure is 1.10 ~ 1.30 dB across the frequency range of 1.8 to 4.0 GHz at room temperature. At 85 °C, WHM2040AE only has 0.30 dB noise increases. At -40 °C, WHM2040AE offers approximately 0.25 dB less noise figure than that at room temperature.

**Figure 4** demonstrates the stability factor  $k$  of the amplifier. It is greater than 1.0 in any frequency band and the amplifier is unconditional stable.

**Figure 5** is the block diagram of internal circuit of WHM2040AE. It is a two-stage amplifier with the DC block capacitors at the input and output RF ports. All the RF matching networks, DC bias circuitries, and temperature compensation circuits are built in.

**Figure 6** demonstrates the application schematic diagram of WHM2040AE. It may require one external decoupling capacitor of 0.01 uF to build a LNA with WHM2040AE. The +5V DC can be applied at Pin 3. No DC block capacitor is required for both input and output RF ports. The NC pins connected to ground are recommended. For +5V line trace length being longer than 6 inch without a decoupling capacitor, an additional 0.01 ~ 0.1 uF decoupling capacitor with minimum rating voltage of 10V may be needed across the +5V line to ground. The capacitor must be rated in the temperature range of -40 °C to 85 °C to ensure the entire circuit working in the specified temperature range.

**Figure 7** shows the mechanical outline and recommended motherboard layout of WHM2040AE. Plenty of ground vias on the motherboard are essential for the RF grounding. The width of the 50-Ohm lines at the input and output RF ports may be different for different property of the substrate.

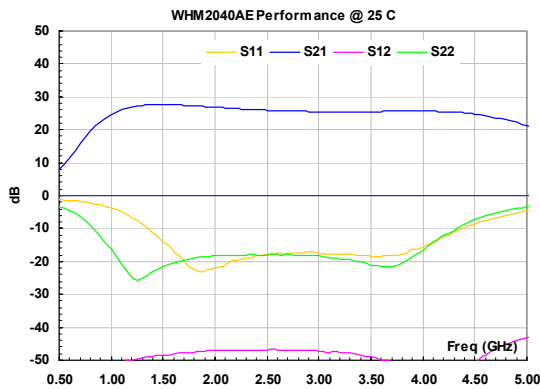

FIG. 1 Typical small signal performance.

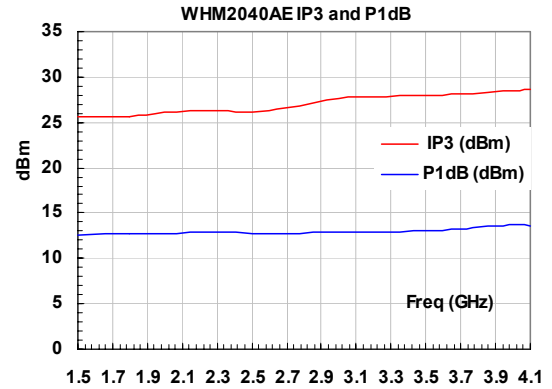

FIG. 2 Typical P<sub>1dB</sub> and IP<sub>3</sub> at room temperature.

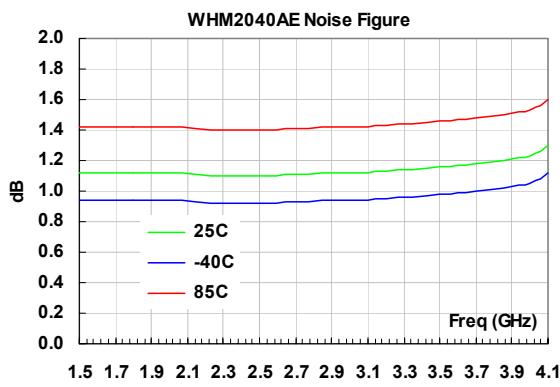

FIG. 3 Noise figure performance at full temperature

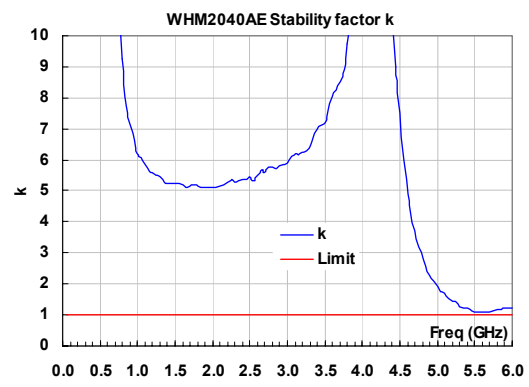

FIG. 4 Measured stability factor *k*

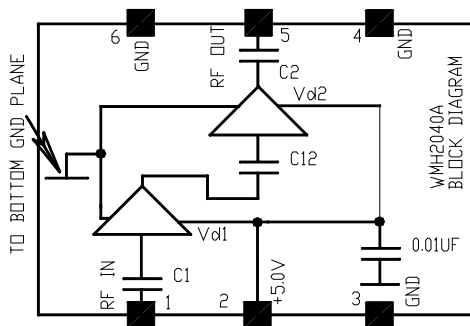

FIG. 5 Block diagram of internal circuit.

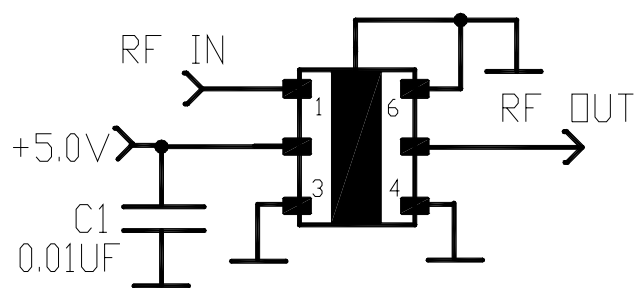

FIG. 6 Typical application schematic for WHM2040AE



WHM2040AE Mechanical Outline, WHM-2:

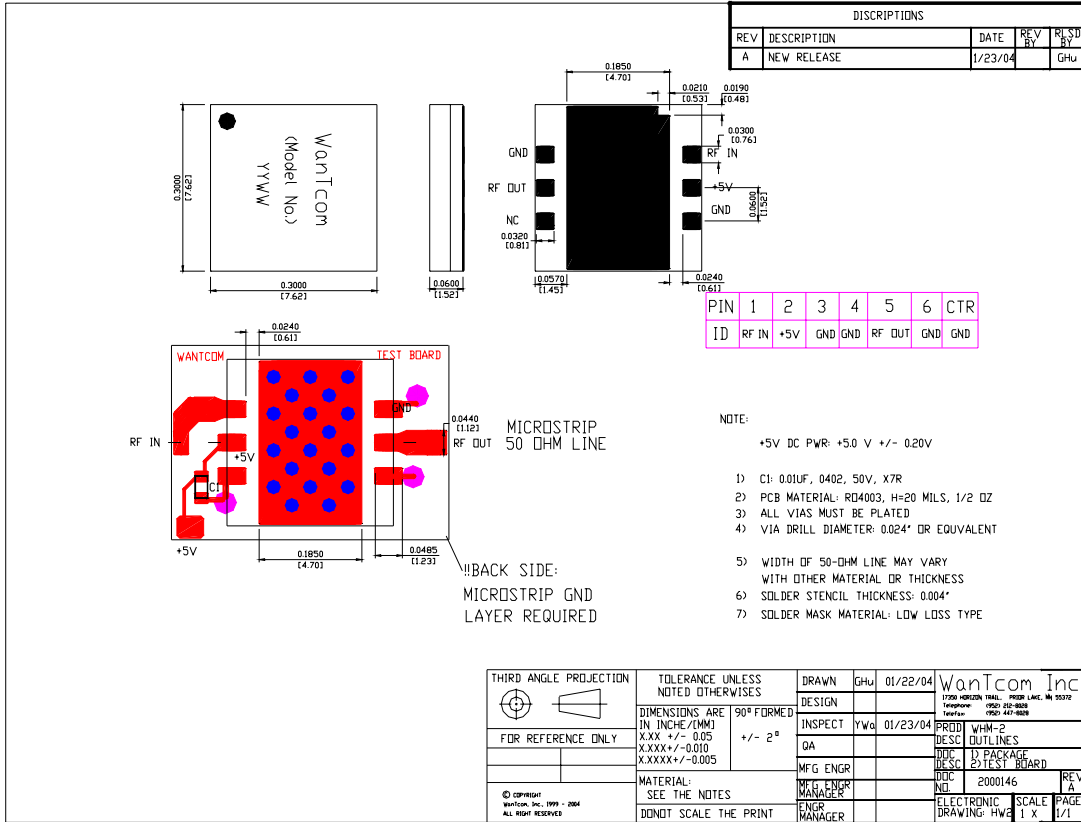

FIG. 7 WHM2040AE outline

Ordering Information

<b>Model Number</b>	WHM2040AE
---------------------	-----------

Waffle pack with the capacity of 81 pieces (9 x 9) is used for the packing. Contact factory for tape and reel packing option for higher volume requirements.



### Small Signal S-Parameters:

IWHM2040AE

!s-parameters at Vdd=5V, Idd=50 mA, including the test board.

!Last updated 1/26/04.

# GHZ s MA R 50

IF(GHz)	MAG S11	ANG S11	MAG S21	ANG S21	MAG S12	ANG S12	MAG S22	ANG S22
0.05	0.995	-17.7	0.003	3.7	0.000020	-40.6	0.984	-15.8
0.1	0.984	-31.3	0.026	-13.3	0.000054	-141.2	0.953	-25.8
0.2	0.796	-89.4	0.406	-80.2	0.000266	-159.6	0.881	-49.4
0.3	0.470	46.1	1.145	-151.6	0.000669	97.3	0.808	-71.1
0.4	0.835	-30.9	1.795	161.7	0.000676	55.8	0.745	-92.3
0.5	0.862	-61.3	2.476	140.4	0.000870	30.6	0.684	-115.5
0.6	0.846	-85.1	3.778	125.1	0.001285	1.3	0.598	-140.9
0.7	0.818	-106.6	6.112	106.0	0.001660	-30.9	0.486	-166.7
0.8	0.773	-127.8	9.485	80.7	0.001956	-68.4	0.357	169.4
0.9	0.721	-149.5	13.289	52.7	0.002356	-101.4	0.240	150.2
1	0.648	-172.4	16.899	23.7	0.002695	-131.7	0.154	136.9
1.1	0.560	164.2	19.914	-4.6	0.002946	-159.5	0.091	132.0
1.2	0.463	140.9	22.149	-31.8	0.003186	178.6	0.059	145.2
1.3	0.366	117.3	23.560	-57.2	0.003406	158.6	0.055	162.3
1.4	0.276	94.1	24.222	-80.9	0.003666	139.8	0.069	169.1
1.5	0.202	69.9	24.349	-102.8	0.003783	125.3	0.085	162.1
1.6	0.142	43.6	24.062	-123.2	0.003929	110.3	0.096	151.0
1.7	0.102	12.7	23.591	-142.2	0.004076	97.2	0.104	137.6
1.8	0.075	-26.8	22.980	-160.0	0.004189	85.5	0.112	124.8
1.9	0.073	-69.0	22.424	-176.9	0.004341	73.3	0.118	111.8
2	0.080	-99.7	21.911	166.9	0.004419	63.5	0.122	96.5
2.1	0.089	-125.1	21.401	151.5	0.004493	54.8	0.122	84.2
2.2	0.104	-145.3	20.886	136.7	0.004453	45.0	0.126	71.4
2.3	0.111	-160.8	20.472	122.1	0.004527	37.8	0.126	58.1
2.4	0.121	-177.0	20.070	107.8	0.004541	29.5	0.126	45.6
2.5	0.126	171.6	19.762	93.5	0.004538	23.2	0.125	32.4
2.6	0.132	158.6	19.520	79.9	0.004540	14.8	0.127	20.7
2.7	0.133	143.6	19.328	66.5	0.004491	7.3	0.127	7.5
2.8	0.134	132.3	19.092	52.9	0.004439	-0.6	0.122	-4.3
2.9	0.139	122.4	18.925	39.3	0.004433	-6.9	0.124	-16.7
3	0.136	110.1	18.817	25.8	0.004373	-15.3	0.122	-28.5
3.1	0.132	96.2	18.763	12.5	0.004198	-21.0	0.114	-43.3
3.2	0.127	81.5	18.668	-1.0	0.004182	-27.8	0.109	-58.0
3.3	0.126	71.7	18.716	-14.6	0.004042	-36.9	0.106	-73.3
3.4	0.125	54.9	18.799	-28.1	0.003727	-44.3	0.097	-92.8
3.5	0.120	37.7	18.856	-41.6	0.003602	-49.7	0.087	-112.2
3.6	0.118	18.1	18.933	-55.5	0.003230	-57.5	0.085	-139.3
3.7	0.123	1.9	19.053	-69.7	0.003022	-65.9	0.085	-169.7
3.8	0.129	-23.0	19.194	-84.4	0.002609	-77.0	0.095	158.6
3.9	0.150	-44.0	19.289	-99.4	0.002113	-87.1	0.116	127.9
4	0.166	-65.7	19.264	-114.6	0.001530	-106.4	0.147	104.6
4.1	0.195	-84.7	19.162	-130.2	0.000738	-132.0	0.196	81.3
4.2	0.234	-103.7	18.900	-146.0	0.000544	162.3	0.245	59.8
4.3	0.284	-121.1	18.448	-162.4	0.000944	95.7	0.301	41.1
4.4	0.327	-139.0	17.832	-179.3	0.001836	71.4	0.366	23.3
4.5	0.368	-155.2	17.093	164.2	0.002697	57.0	0.432	6.2
5	0.582	127.6	11.628	82.4	0.006909	-3.4	0.677	-71.5
5.5	0.720	57.3	6.807	7.7	0.009219	-45.2	0.782	-132.3
6	0.791	-6.1	4.135	-57.8	0.009532	-82.3	0.815	174.2

\*\*\*\*\*