



**Pb-free
HEAT**



5307S Series

Single Color ϕ 5 Flush Mount Round Shape Type

Features

Package	ϕ 5 Round shape type, Water Clear epoxy
Product features	<ul style="list-style-type: none"> • Outer Dimension ϕ 5 Round shape type • Operation temperature range. Storage Temperature : -30°C~100°C Operating Temperature : -30°C~85°C • No lead package and lead-free soldering compatible • RoHS compliant
Dominant wavelength	Green : 558nm (BG) : 567nm (PG) Yellow Green : 572nm (PY) Yellow : 590nm (AY) Orange : 606nm (AA) Red : 624nm (VR) : 647nm (BR) : 630nm (PR)
Half Intensity Angle	BG,PG,PY : 75 deg. AY,AA,VR : 128 deg. BR : 40 deg. PR : 132 deg.
Die materials	BG,PG,PY,PR : GaP AY,AA,VR : GaAsP BR : GaAlAs
Rank grouping parameter	Sorted by luminous intensity per rank taping
Soldering methods	TTW (Through The Wave) soldering and manual soldering
ESD	More than 2kV(HBM)
Packing	Bulk : 200pcs(MIN.)

Recommended Applications

Amusement Equipment, Electric Household Appliances, OA/FA, Other General Applications

Color and Luminous Intensity

(Ta=25°C)

Part No.	Material	Emitted Color	Lens Color		Dominant Wavelength λd (nm)		Luminous Intensity I_v (mcd)		
					TYP.	I_F	MIN.	TYP.	I_F
					BG5307S	GaP	Green	Water Clear	Clear
PG5307S	GaP	567	20	4	8	20			
PY5307S	GaP	Yellow Green	572	20	5	10	20		
AY5307S	GaAsP	Yellow	590	20	3	6	20		
AA5307S	GaAsP	Orange	606	20	3	6	20		
VR5307S	GaAsP	Red	624	20	3	6	20		
BR5307S	GaAlAs		647	20	5	10	20		
PR5307S	GaP		630	10	0.6	1.2	10		

Absolute Maximum Ratings

(Ta=25°C)

Item	Symbol	Absolute Maximum Ratings								Unit
		BG	PG	PY	AY	AA	VR	BR	PR	
Power Dissipation	P_d	125	125	125	125	125	75	100	75	mW
Forward Current	I_F	50	50	50	50	50	30	50	30	mA
Pulse Forward Current ※1	I_{FRM}	100	100	100	100	100	100	300	100	mA
Derating (Ta=25°C or higher)	ΔI_F	0.67	0.67	0.67	0.67	0.67	0.33	0.67	0.33	mA/°C
Reverse Voltage	V_R	4	4	4	4	4	4	4	4	V
Operating Temperature	T_{opr}	-30~+85								°C
Storage Temperature	T_{stg}	-30~+100								°C

※1 I_{FRM} Measurement condition : Pulse Width \leq 1ms., Duty \leq 1/20.

Electro-Optical Characteristics(BG,PG,PY,AY,AA,VR,BR)

(Ta=25°C)

Item	Conditions	Symbol	Characteristics								Unit
			BG	PG	PY	AY	AA	VR	BR		
Forward Voltage	I _F =20mA	V _F	TYP.	2.1	2.1	2.1	2.2	2.2	2	1.7	V
			MAX.	2.5	2.5	2.5	2.5	2.5	2.5	2.0	
Reverse Current	V _R =4V	I _R	MAX.	100	100	100	100	100	100	100	μ A
Peak Wavelength	I _F =20mA	λ_p	TYP.	555	560	570	580	605	630	660	nm
Dominant Wavelength	I _F =20mA	λ_d	TYP.	558	567	572	590	606	624	647	nm
Spectral Line Half Width	I _F =20mA	$\Delta \lambda$	TYP.	30	30	30	30	30	30	30	nm
Half Intensity Angle	I _F =20mA	2 θ 1/2	TYP.	75	75	75	128	128	128	40	deg.

Electro-Optical Characteristics(PR)

(Ta=25°C)

Item	Conditions	Symbol	Characteristics		Unit
				PR	
Forward Voltage	I _F =10mA	V _F	TYP.	2.1	V
			MAX.	2.5	
Reverse Current	V _R =4V	I _R	MAX.	100	μ A
Peak Wavelength	I _F =10mA	λ_p	TYP.	700	nm
Dominant Wavelength	I _F =10mA	λ_d	TYP.	630	nm
Spectral Line Half Width	I _F =10mA	$\Delta \lambda$	TYP.	100	nm
Half Intensity Angle	I _F =10mA	2 θ 1/2	TYP.	132	deg.

Luminous Intensity Rank

(Ta=25°C)

Rank	I _v (mcd)															
	BG		PG		PY		AY		AA		VR		BR		PR	
	I _F =20mA		I _F =20mA		I _F =20mA		I _F =20mA		I _F =20mA		I _F =20mA		I _F =20mA		I _F =10mA	
	MIN.	MAX.	MIN.	MAX.	MIN.	MAX.	MIN.	MAX.	MIN.	MAX.	MIN.	MAX.	MIN.	MAX.	MIN.	MAX.
A	2.0	4.0	4.0	8.0	5.0	10.0	3.0	6.0	3.0	6.0	3.0	6.0	5.0	10.0	0.60	1.20
B	2.8	5.6	5.6	11.2	7.0	14.0	4.2	8.4	4.2	8.4	4.2	8.4	7.0	14.0	0.84	1.68
C	4.0	8.0	8.0	16.0	10.0	20.0	6.0	12.0	6.0	12.0	6.0	12.0	10.0	20.0	1.20	2.40
D	5.6	11.2	11.2	22.4	14.0	28.0	8.4	16.8	8.4	16.8	8.4	16.8	14.0	28.0	1.68	3.36
E	8.0	-	16.0	-	20.0	-	12.0	-	12.0	-	12.0	-	20.0	-	2.40	-

Please contact our sales staff concerning rank designation.

Technical Data(BG)

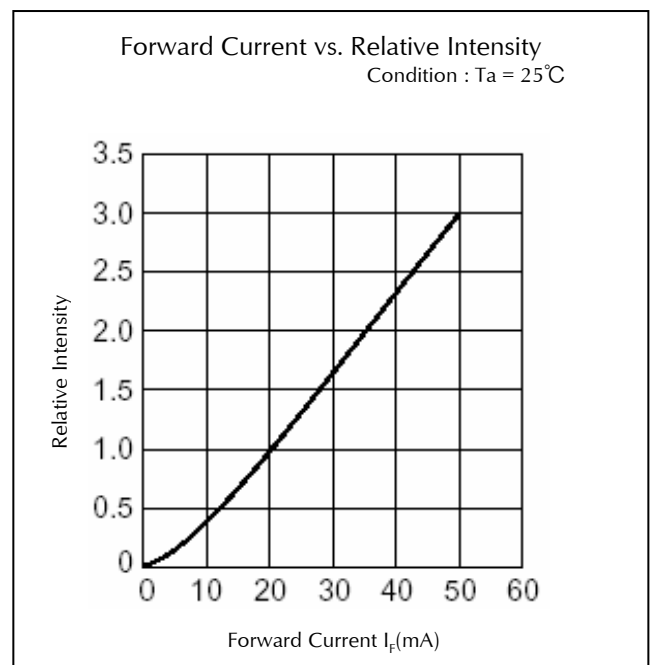
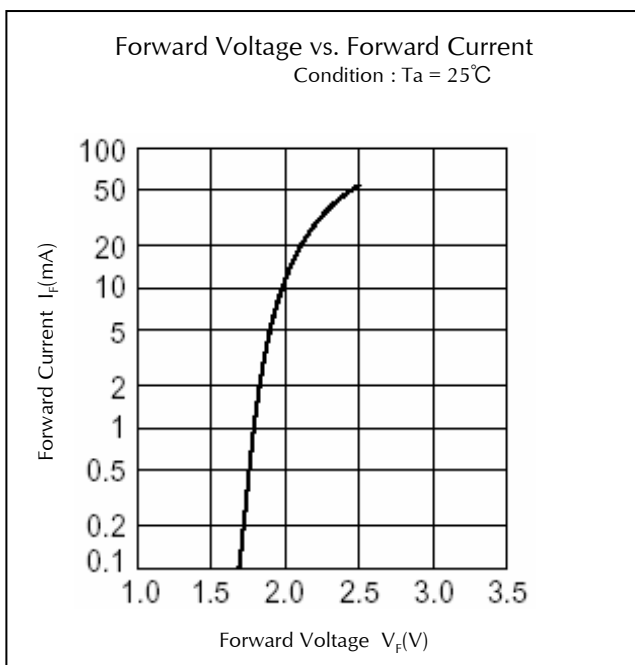
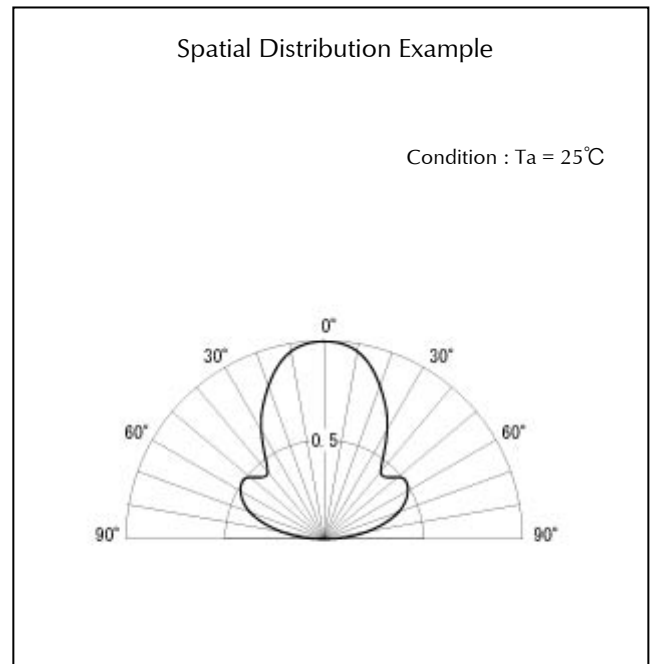
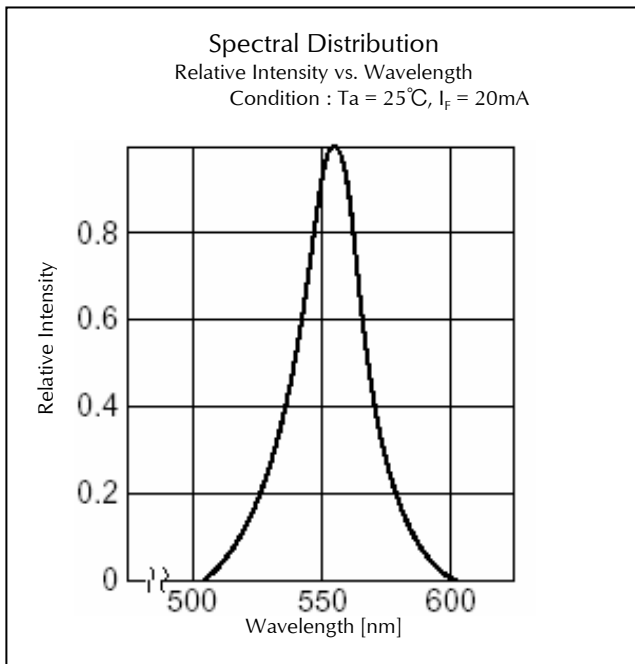

Technical Data(BG)

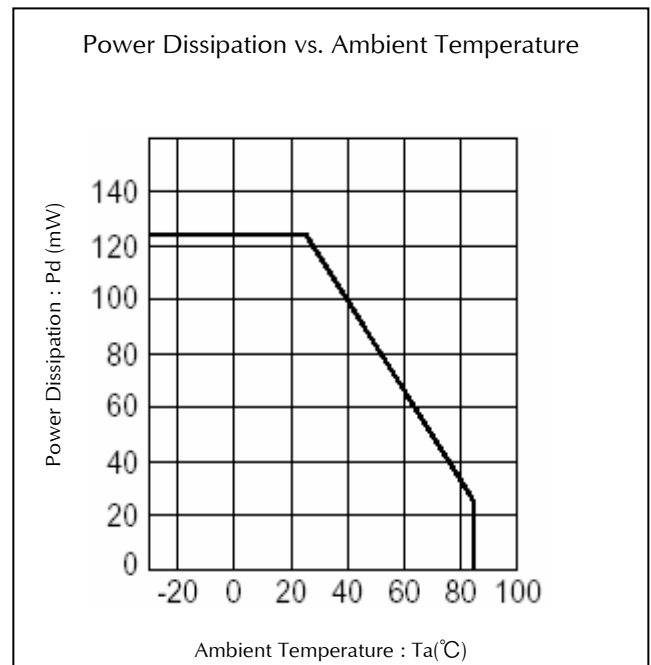
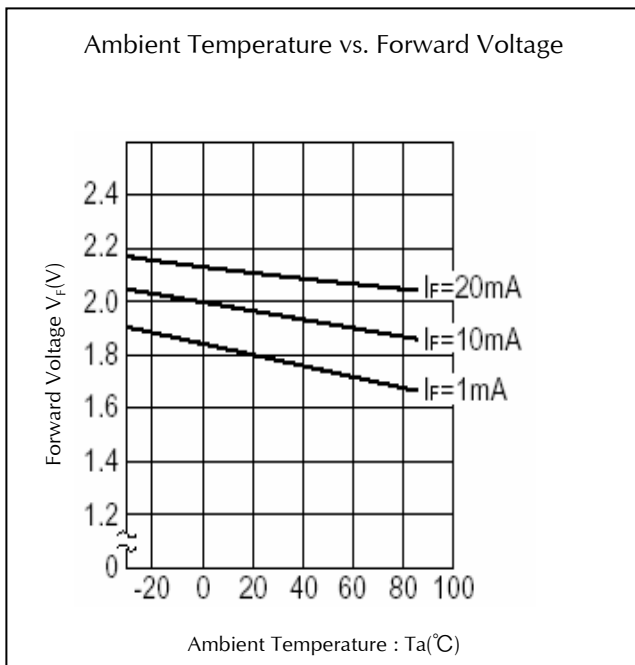
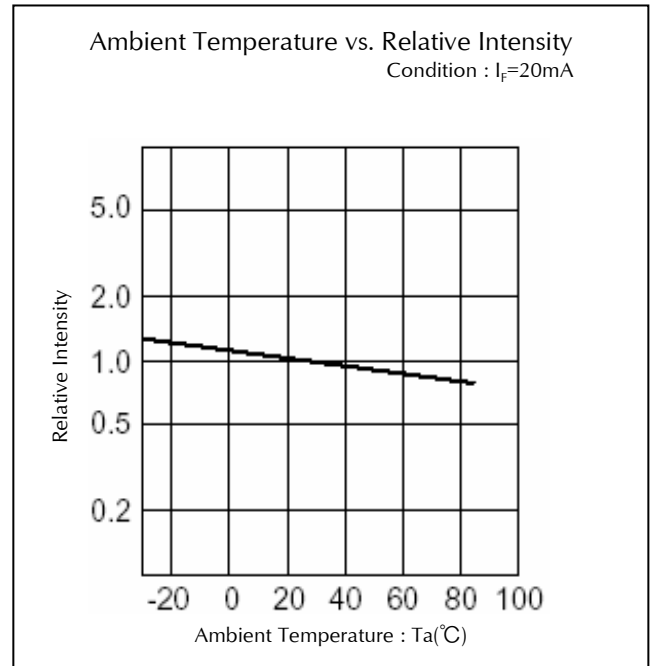
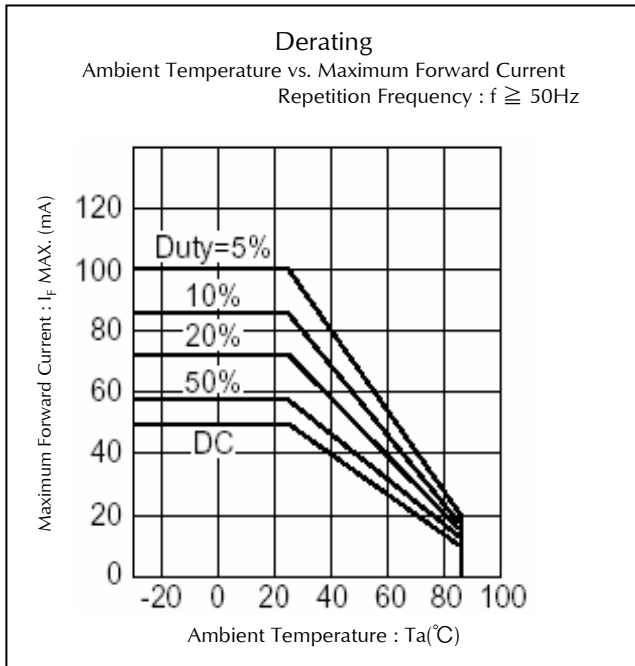

Technical Data(BG)

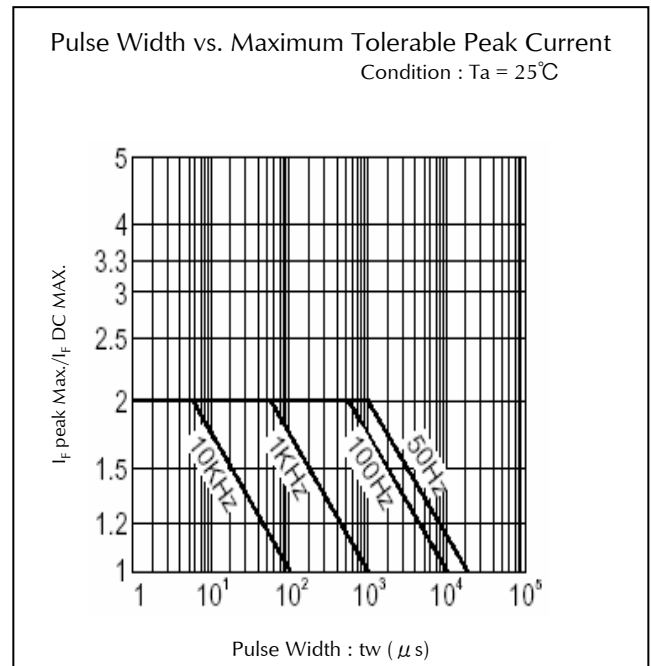
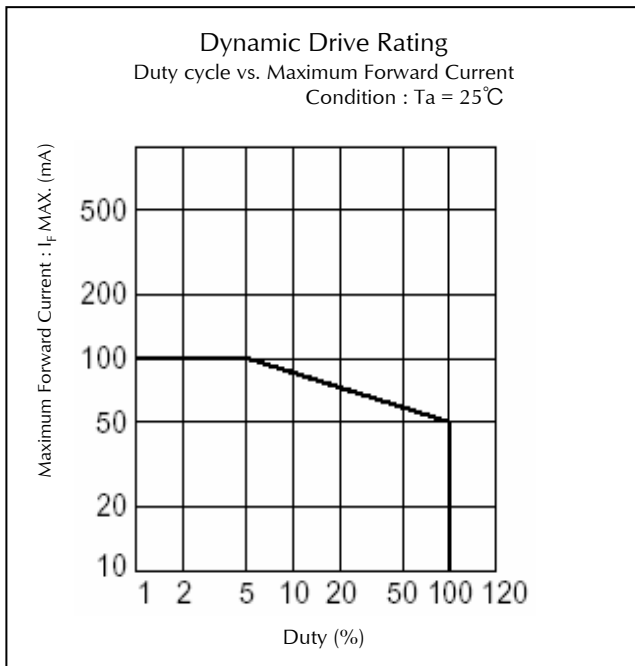

Technical Data(PG)

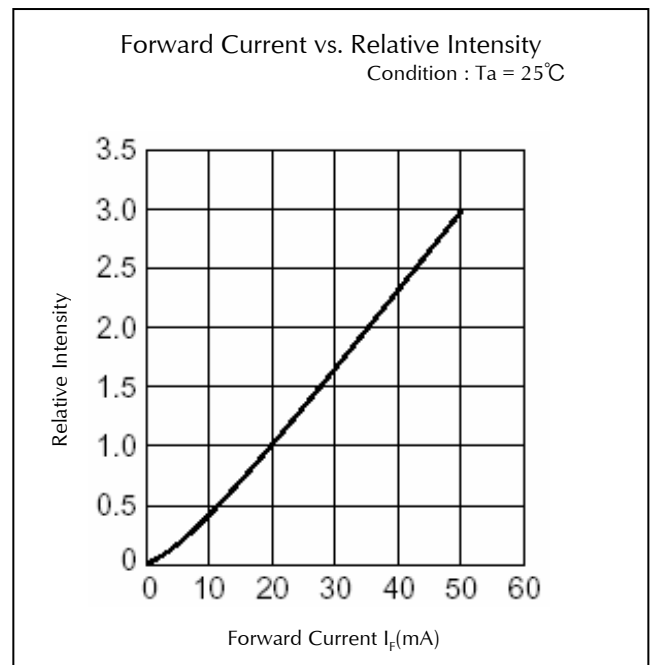
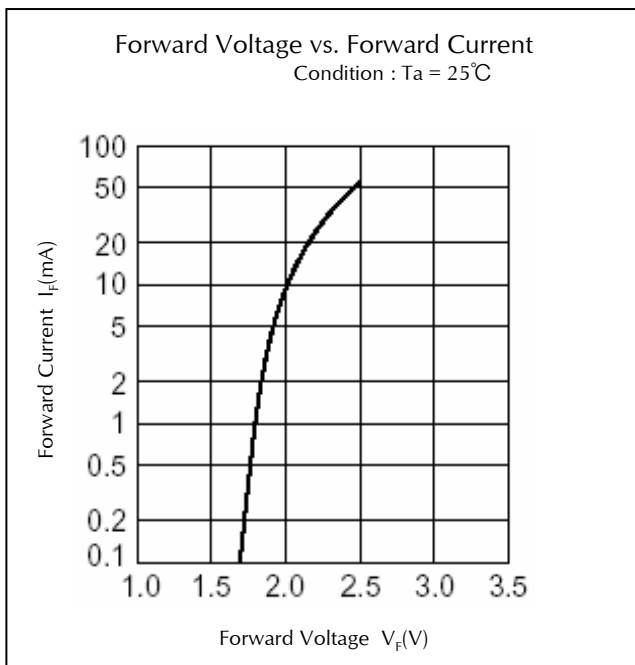
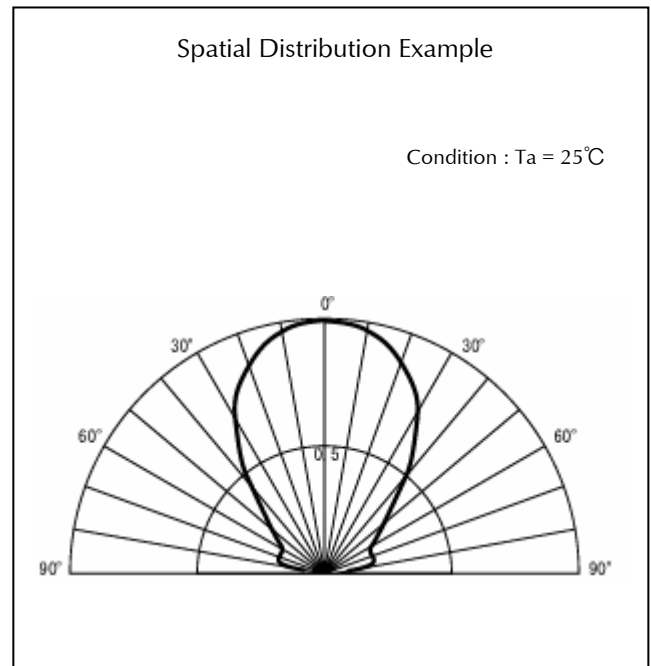
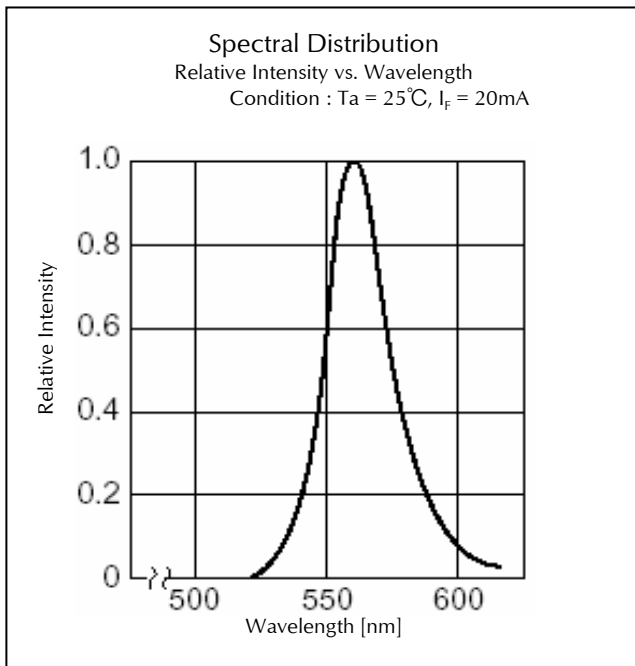

Technical Data(PG)

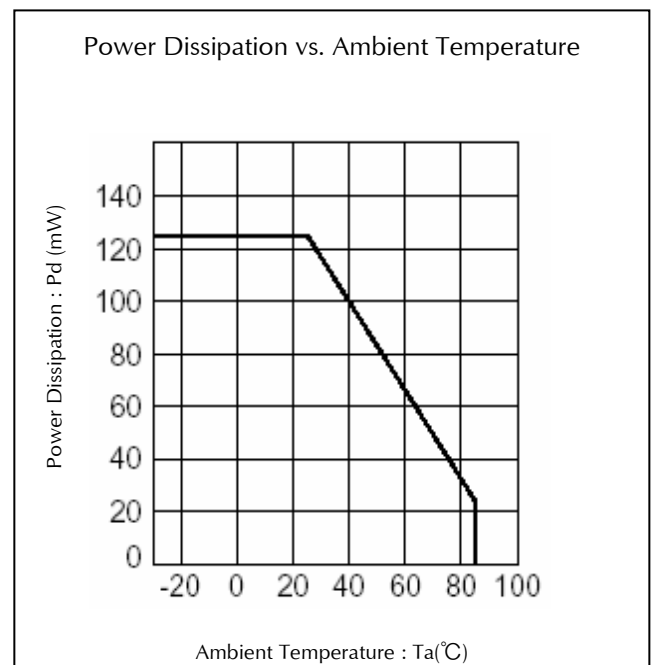
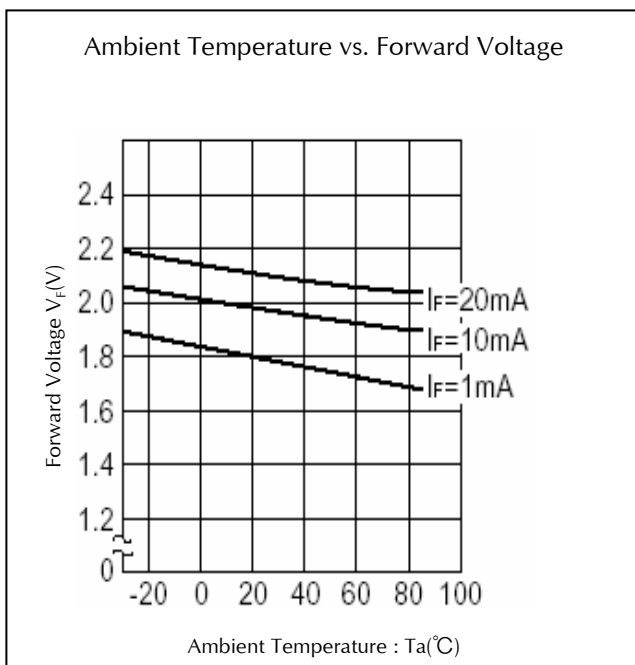
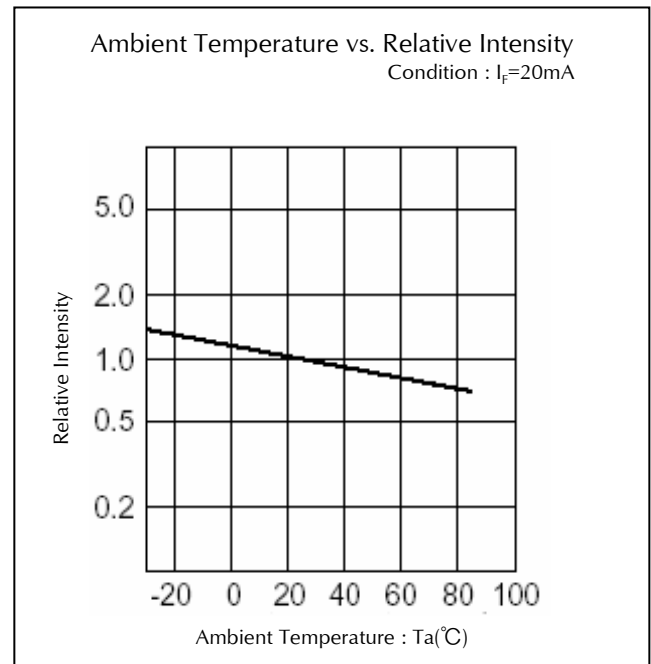
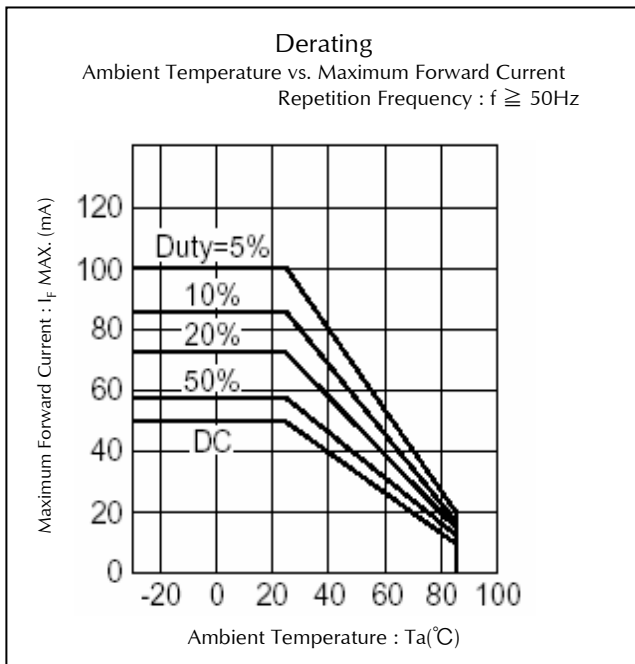

Technical Data(PG)

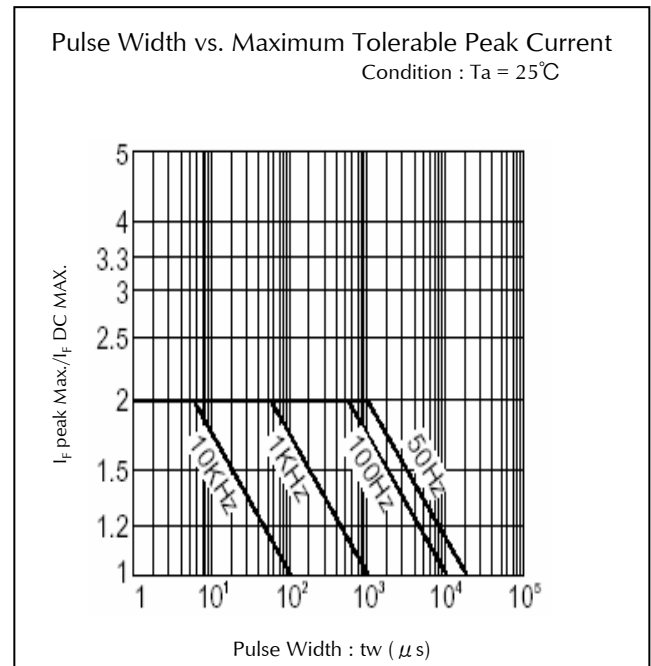
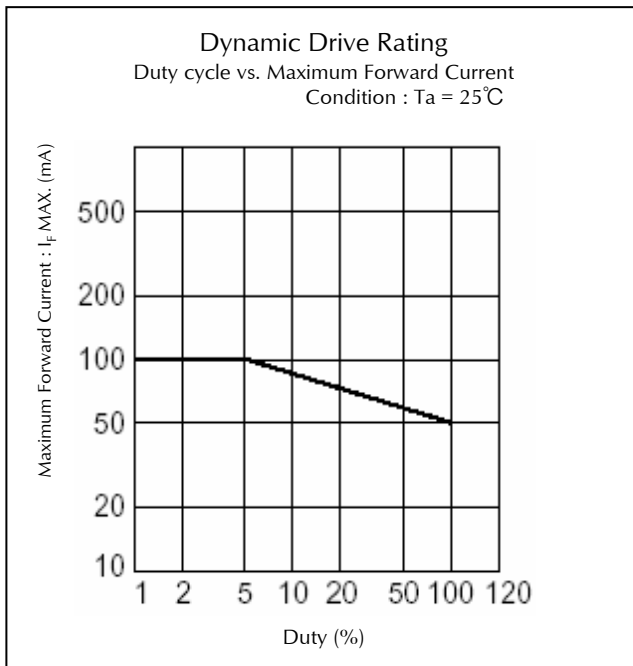

Technical Data(PY)

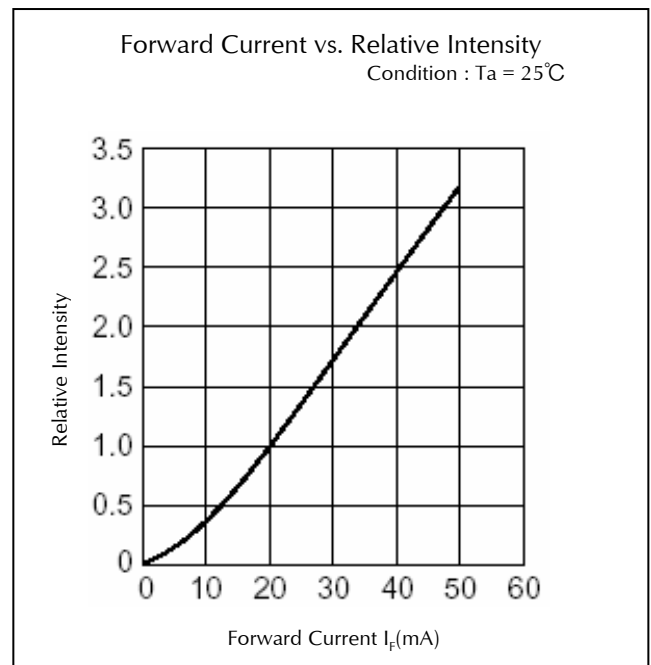
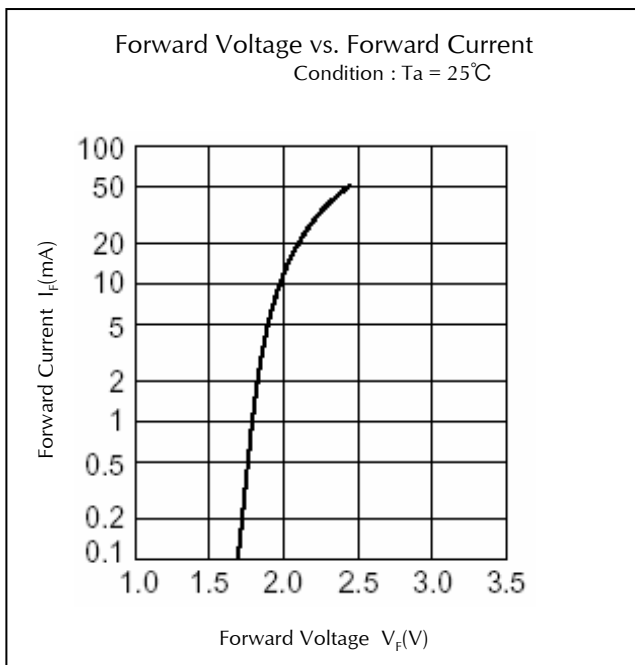
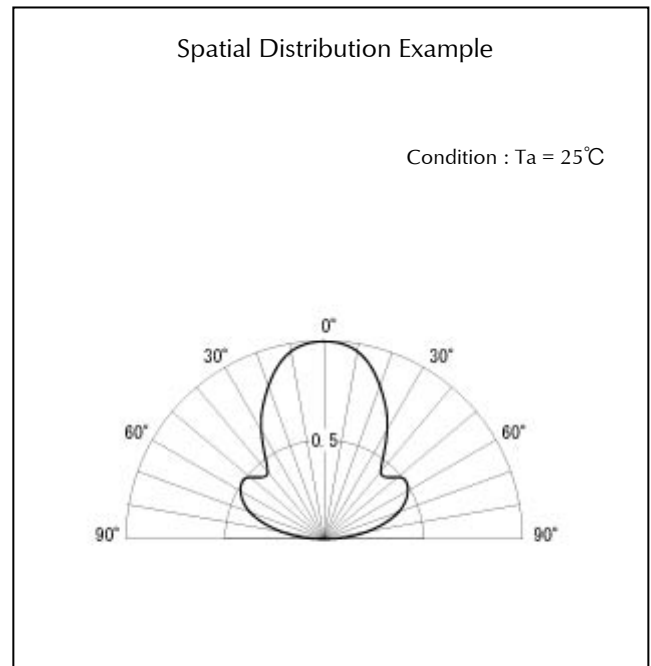
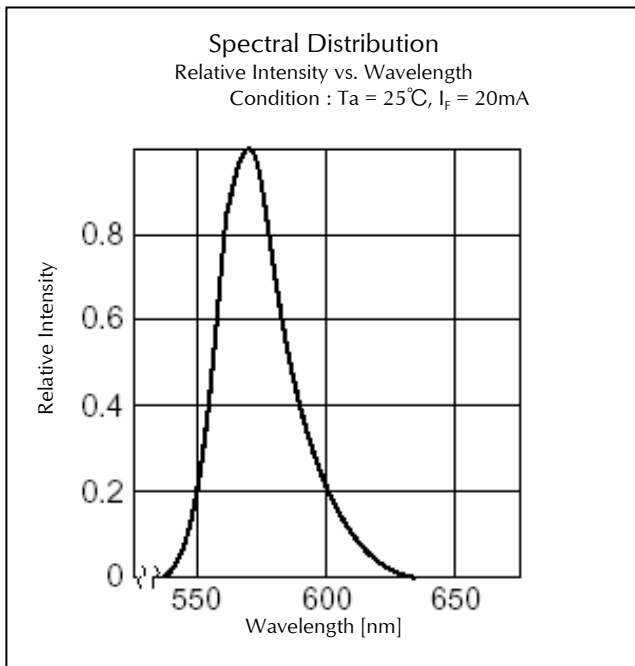

Technical Data(PY)

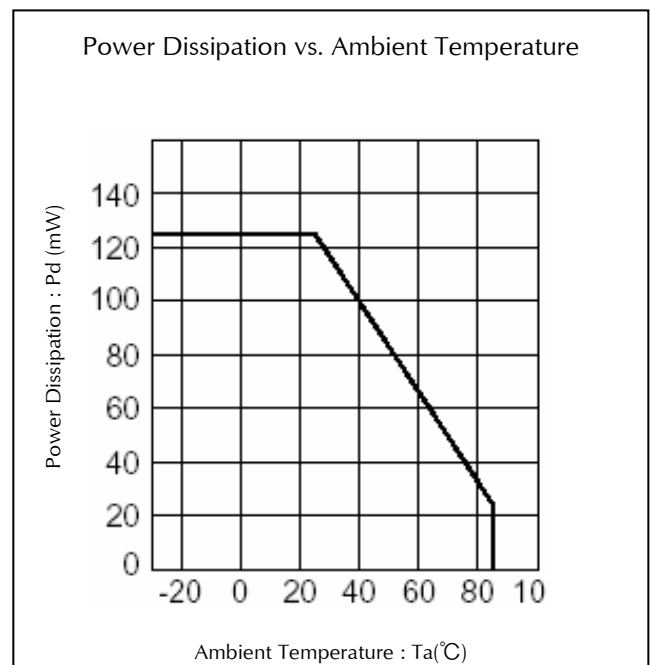
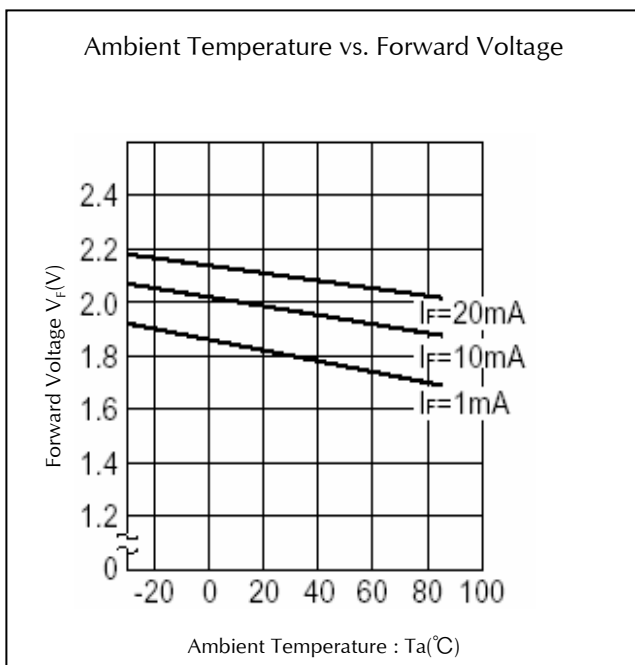
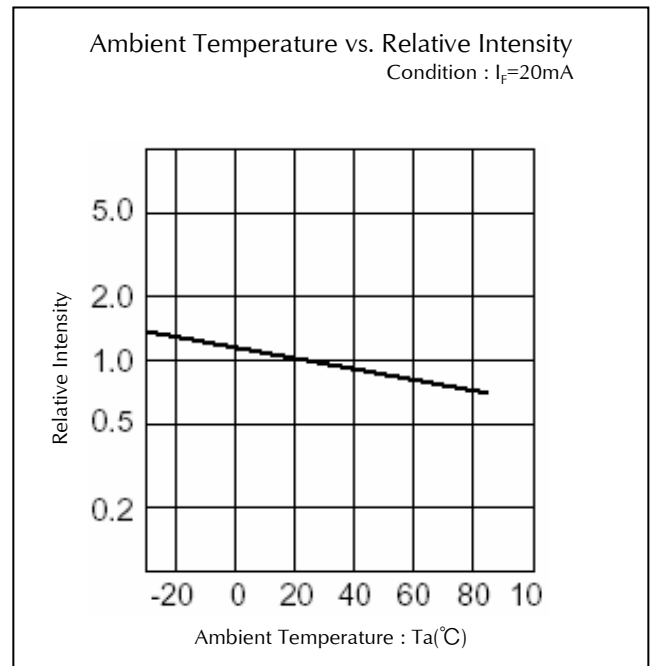
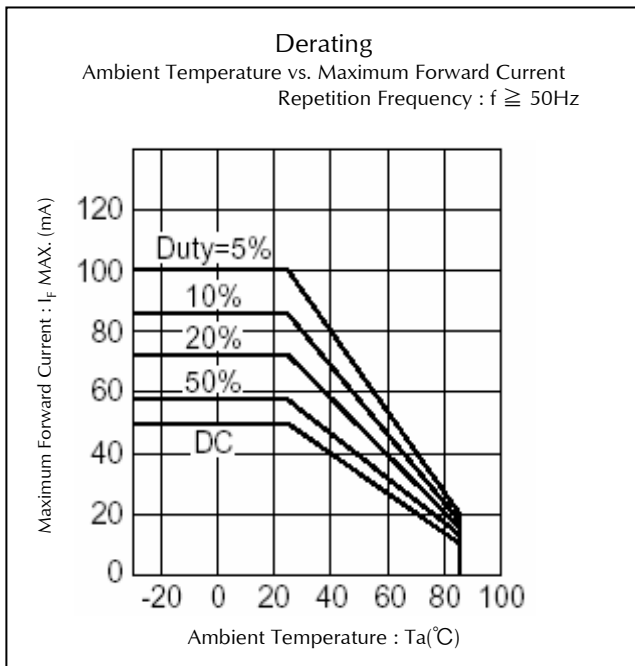

Technical Data(PY)

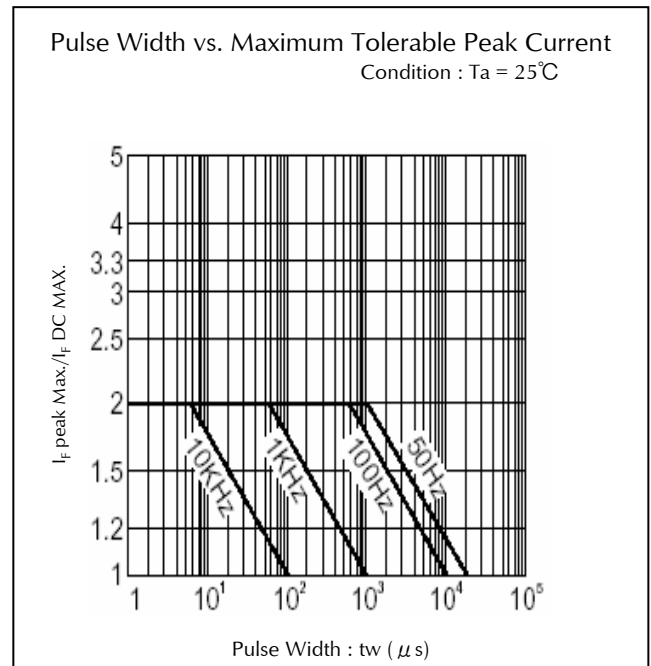
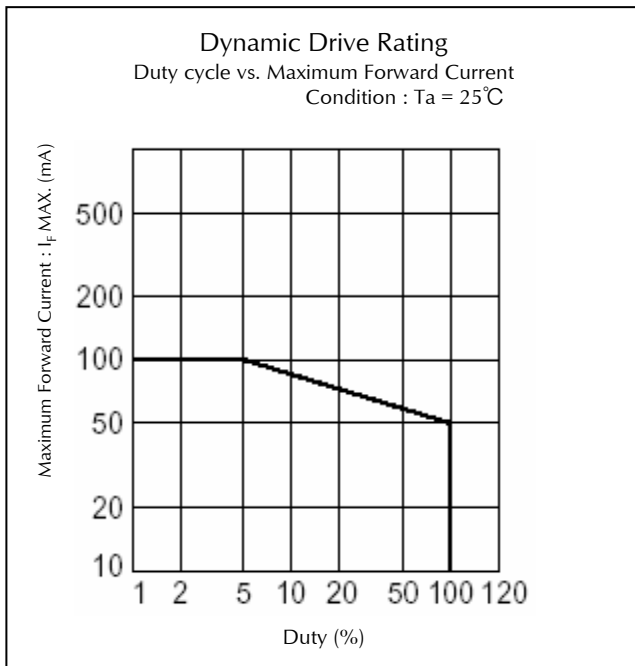

Technical Data(AY)

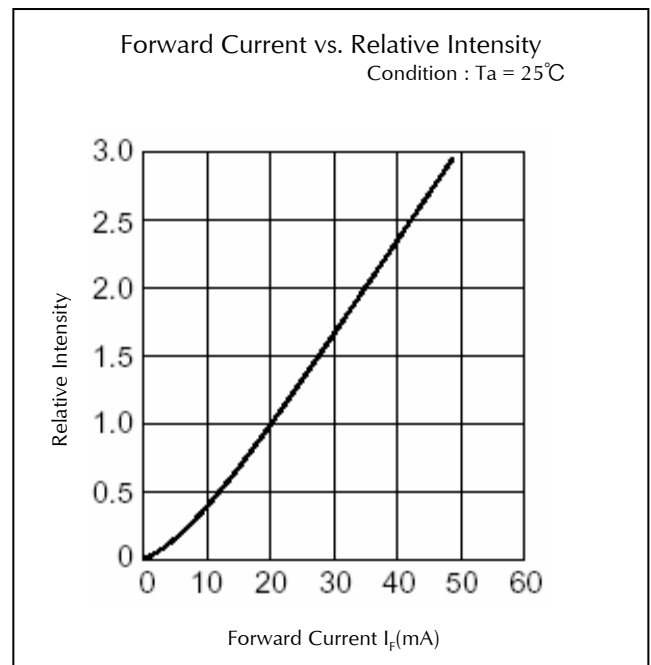
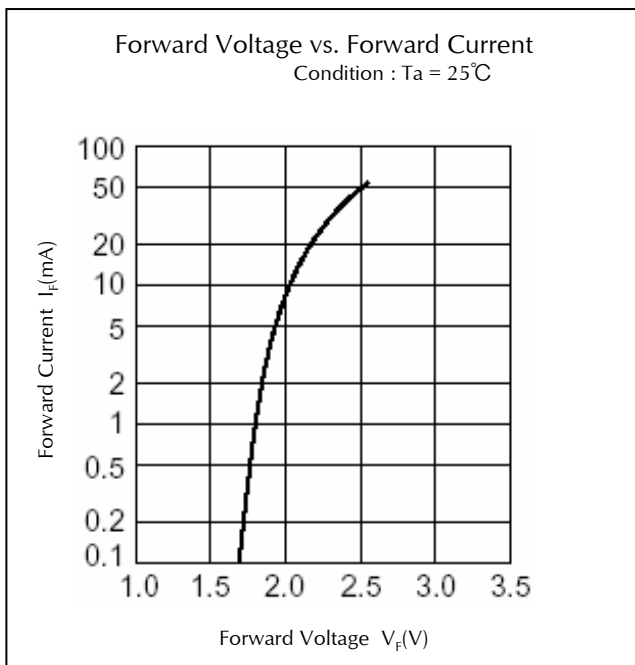
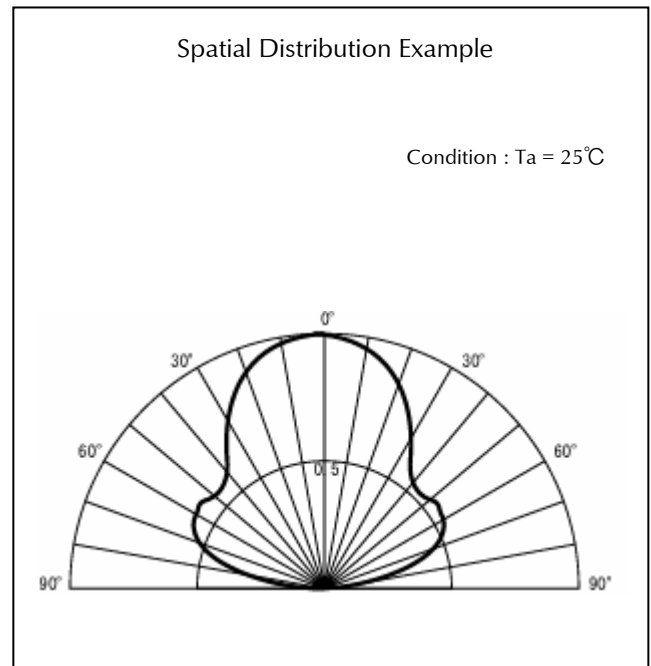
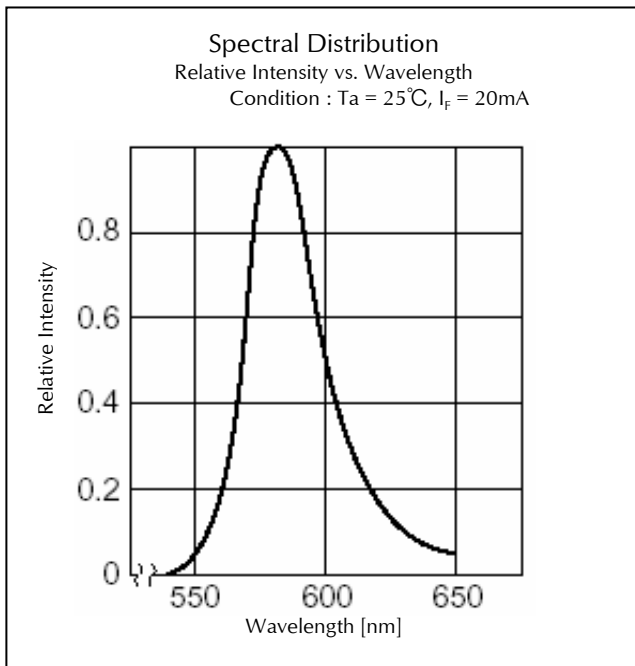

Technical Data(AY)

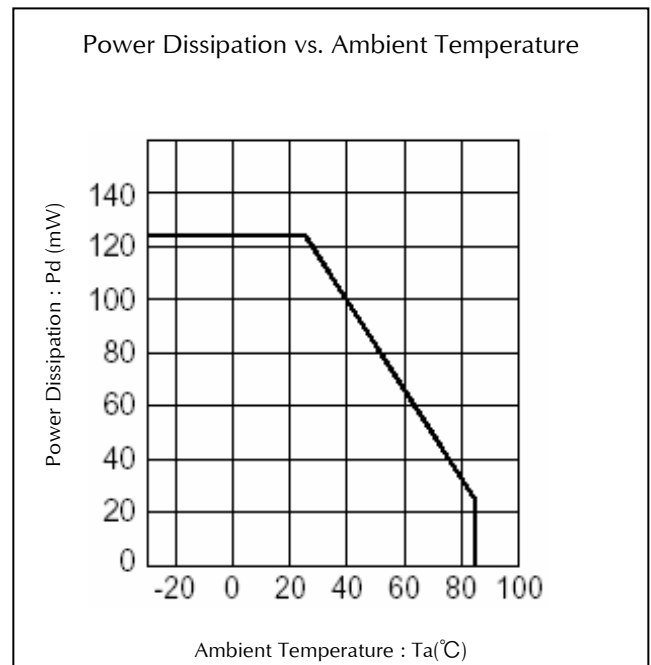
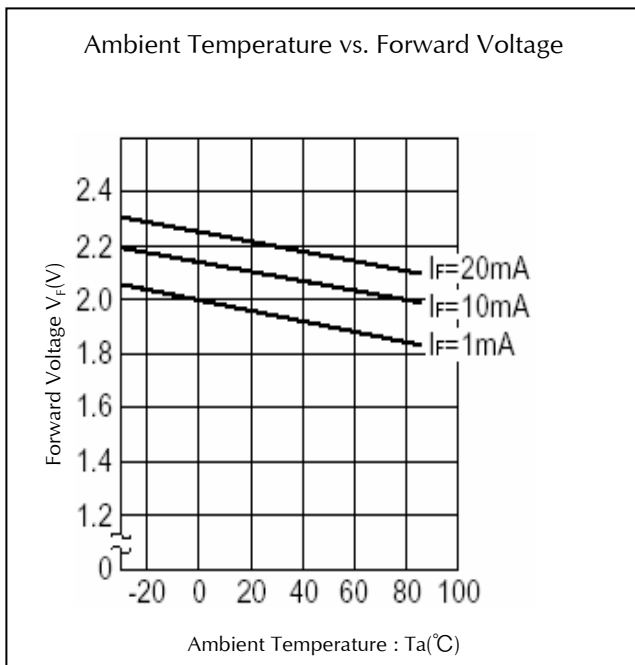
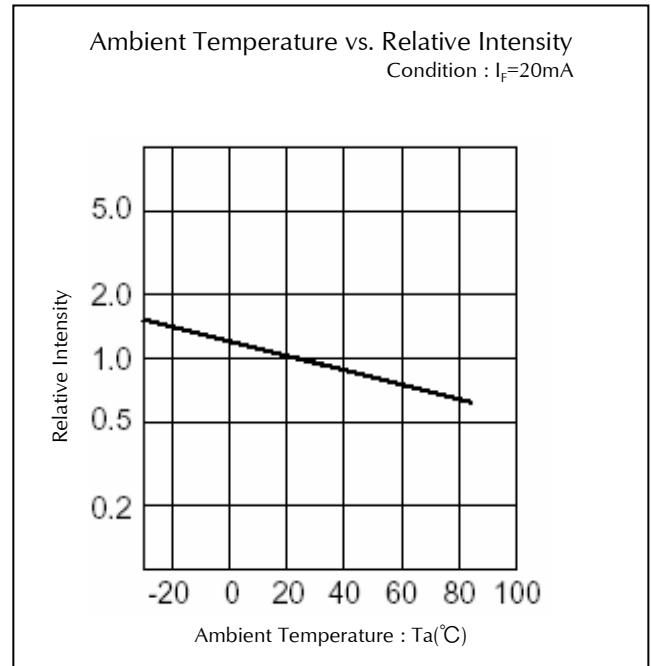
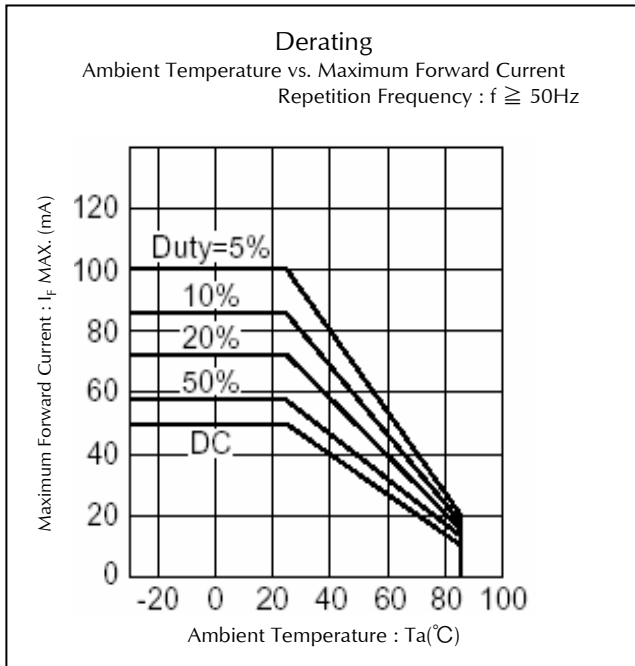

Technical Data(AY)

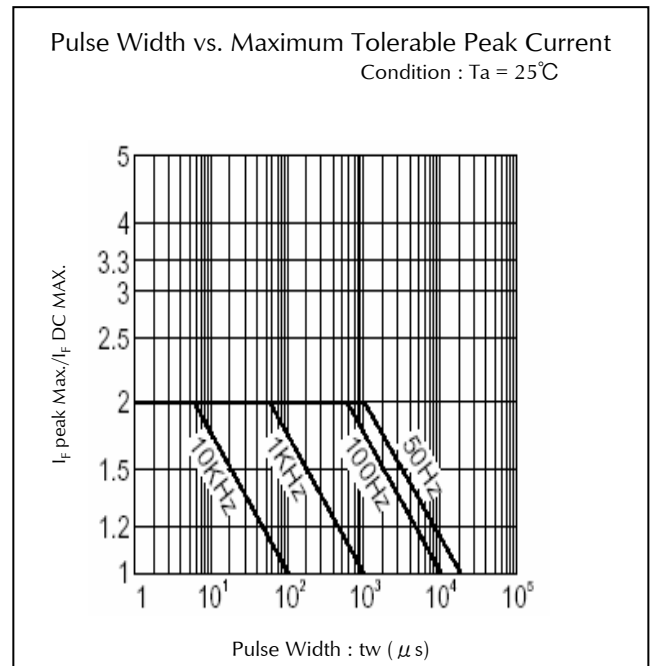
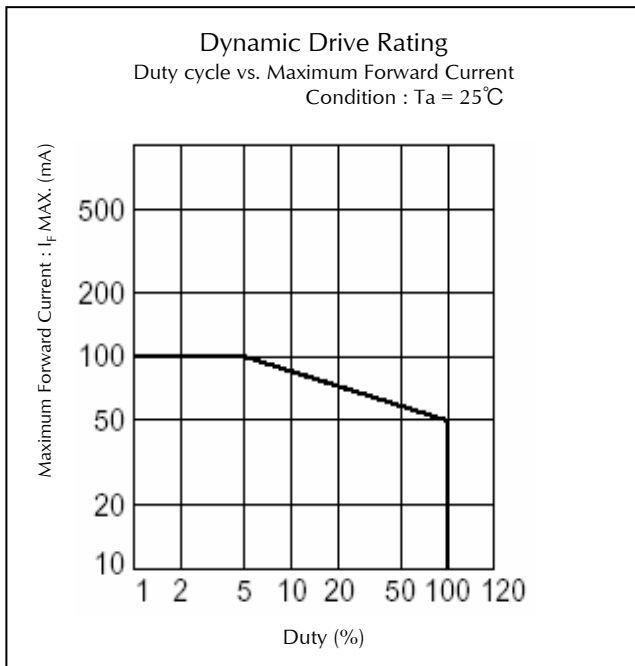

Technical Data(AA)

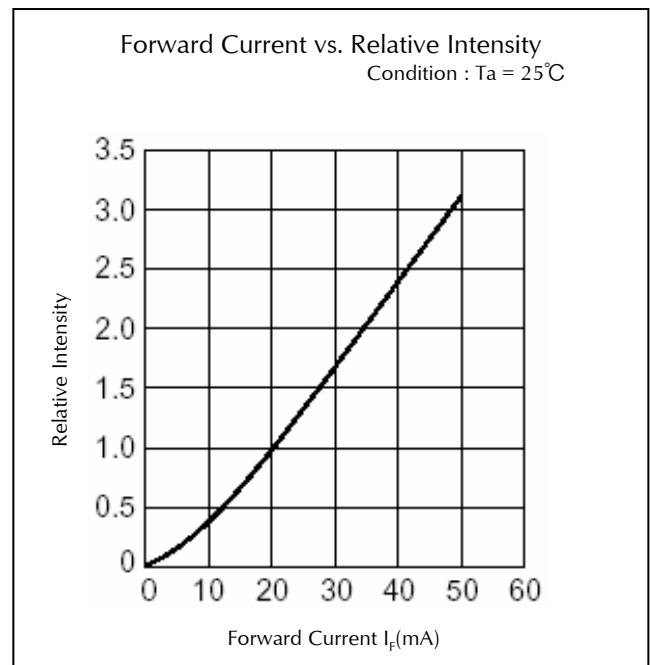
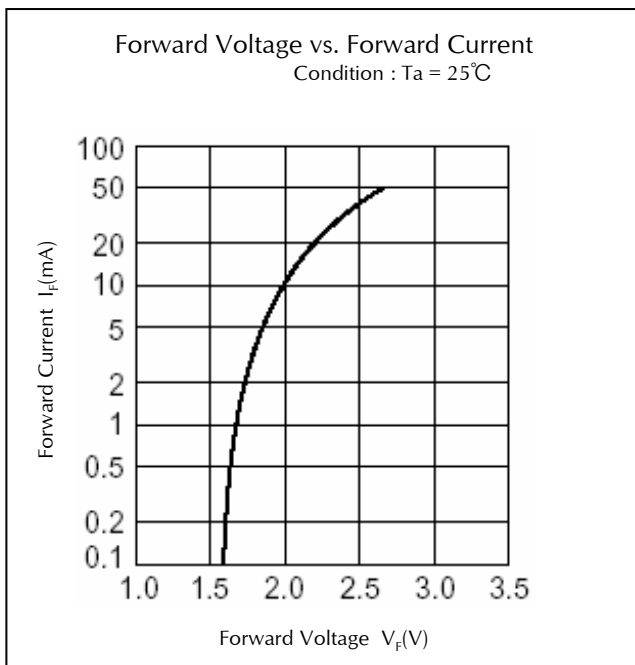
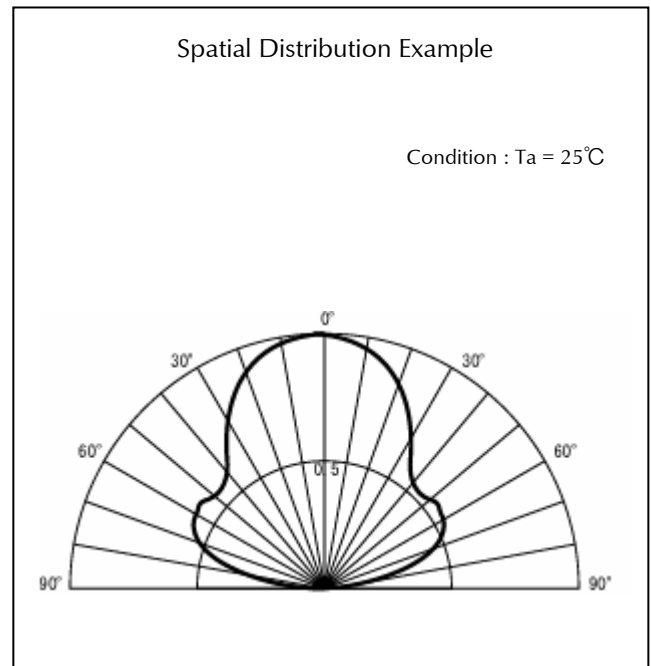
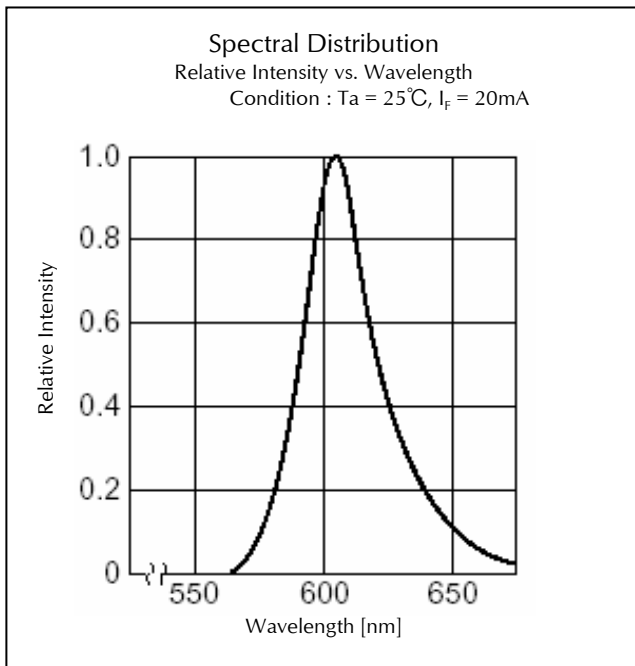

Technical Data(AA)

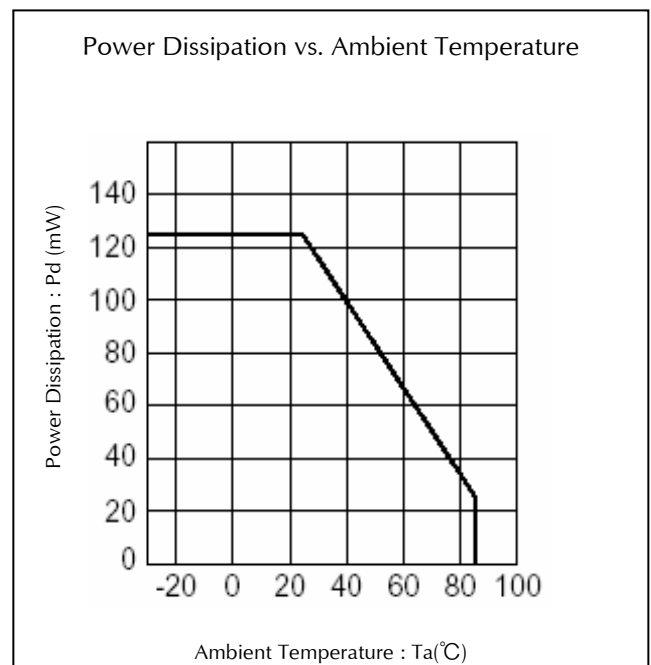
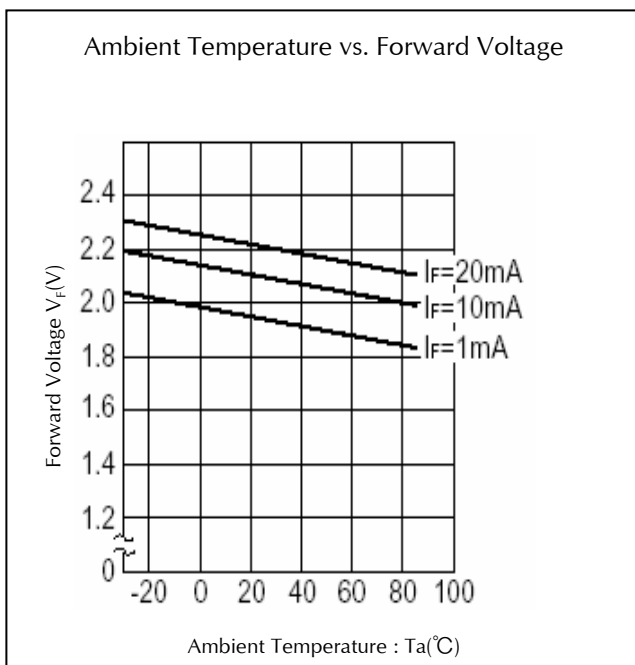
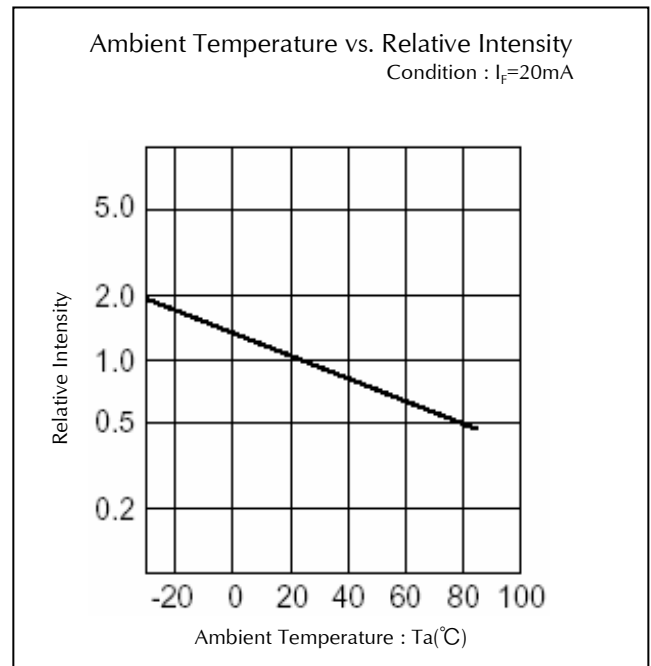
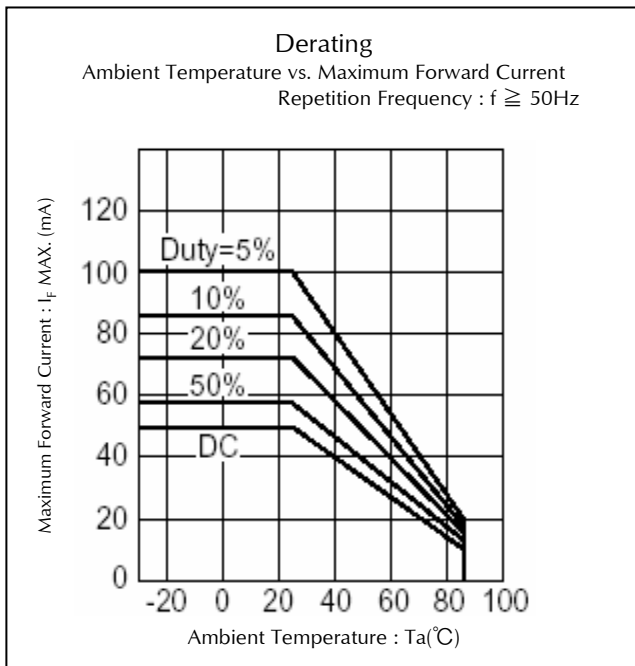

Technical Data(AA)

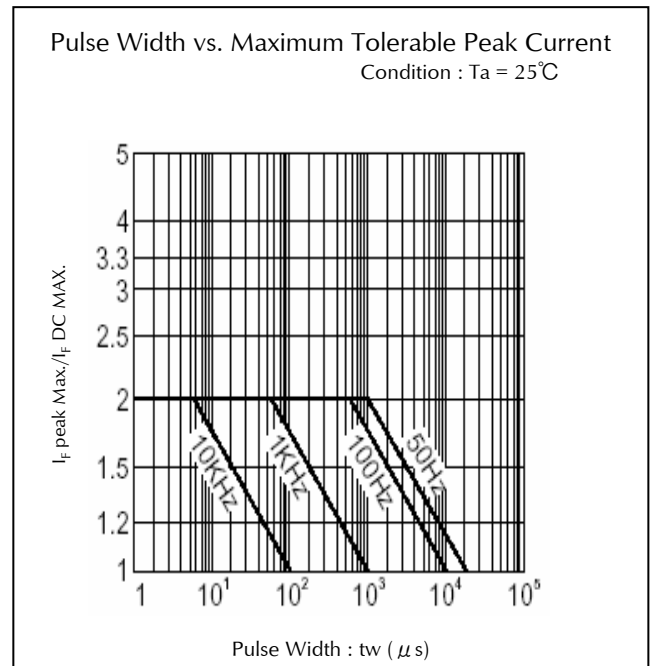
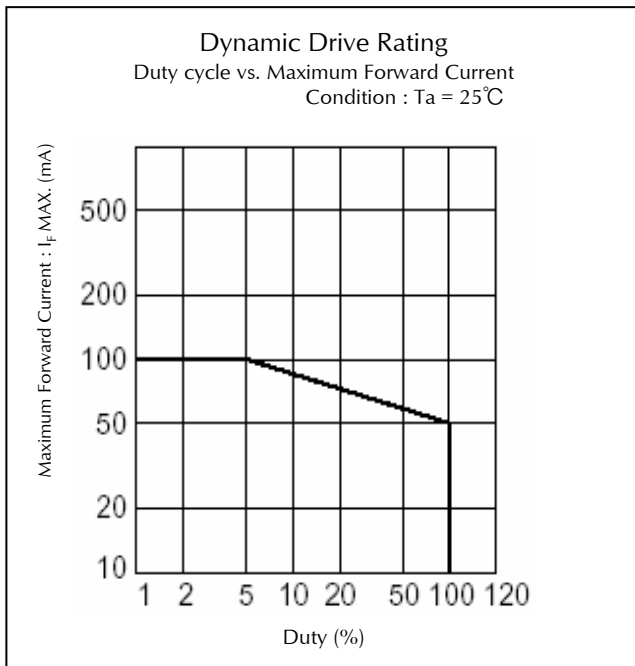

Technical Data(VR)

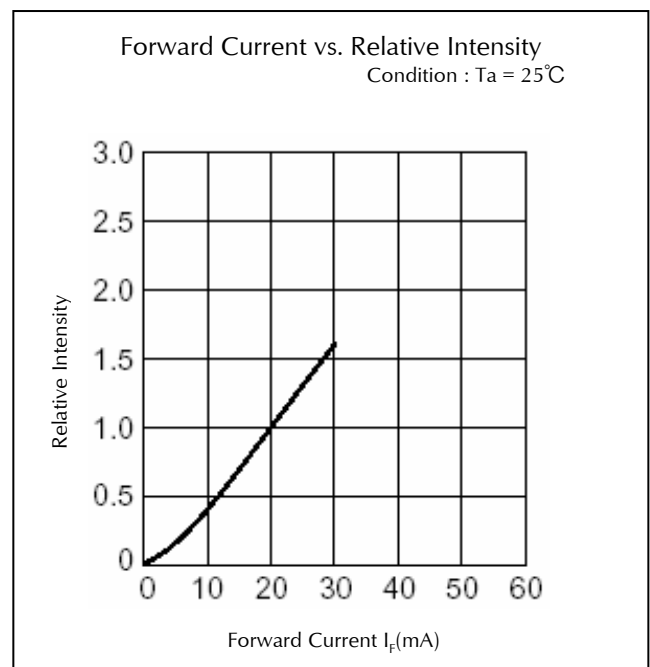
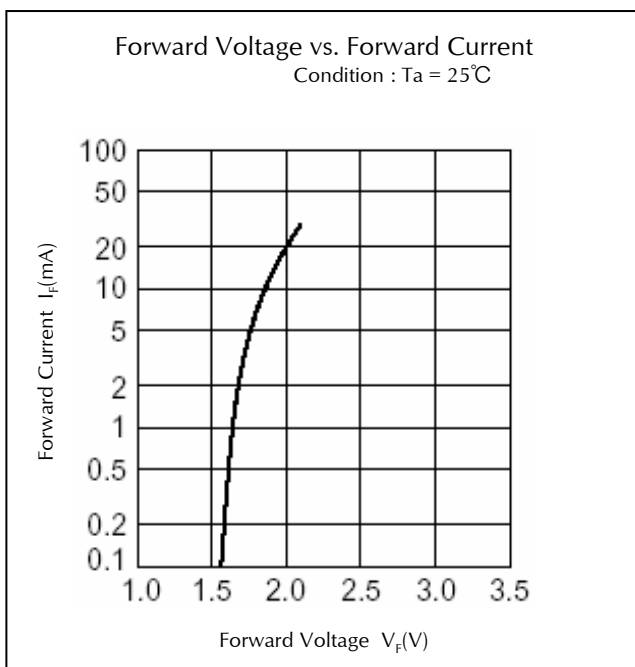
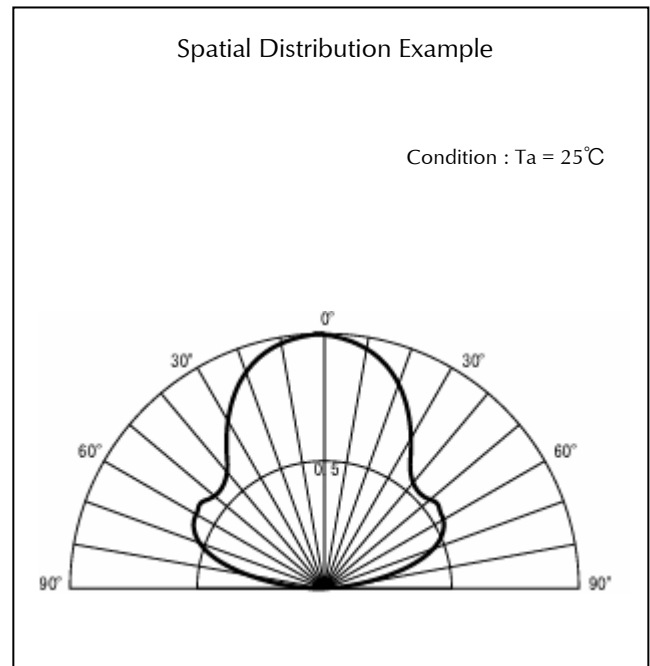
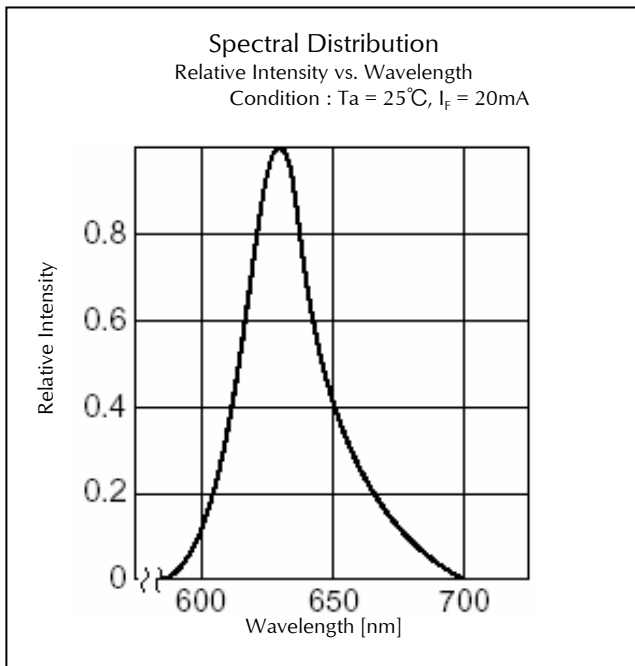

Technical Data(VR)

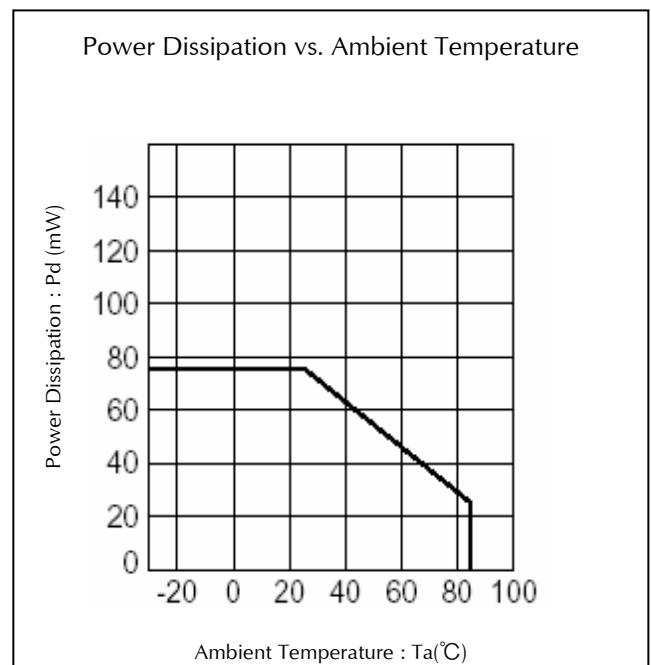
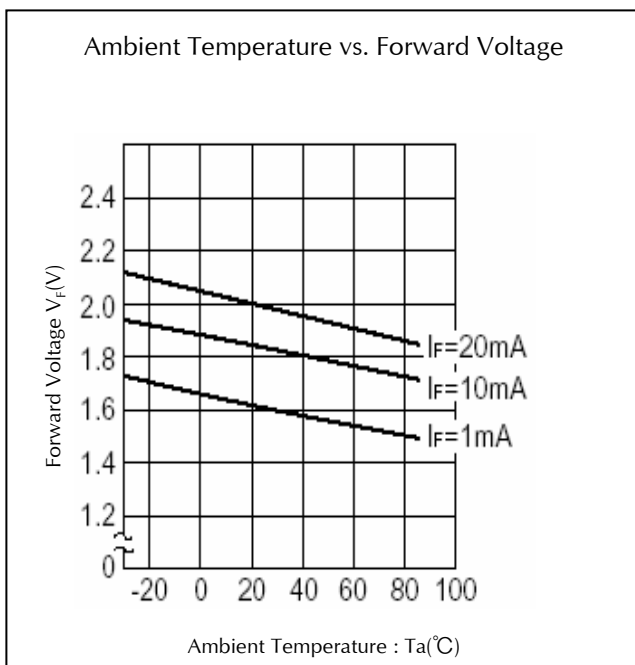
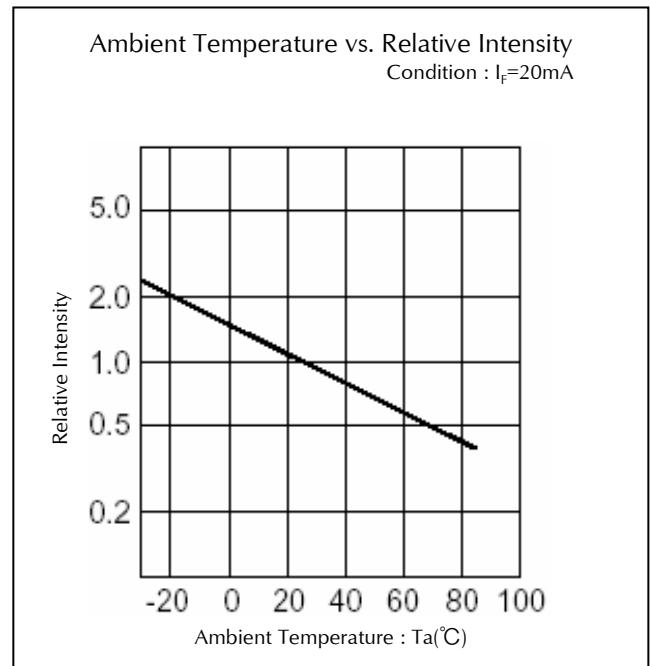
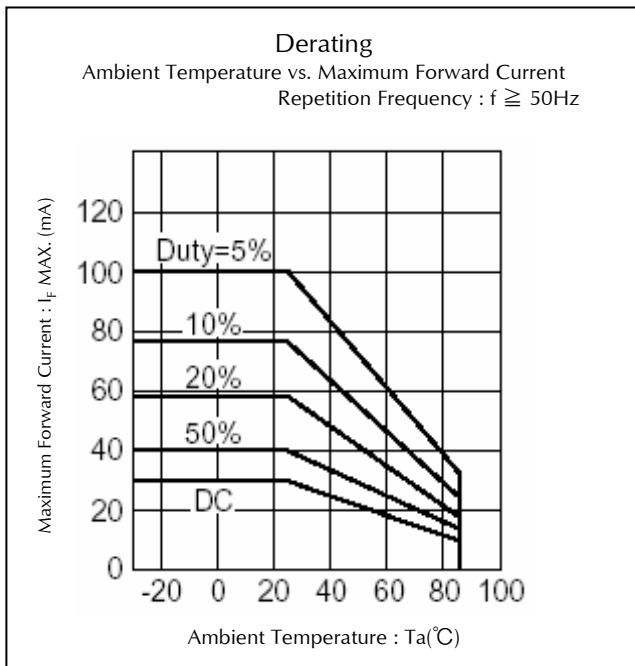

Technical Data(VR)

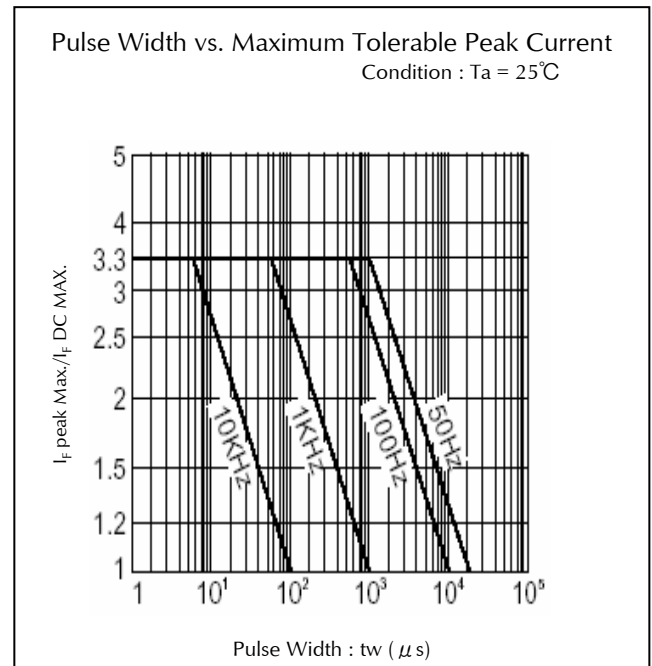
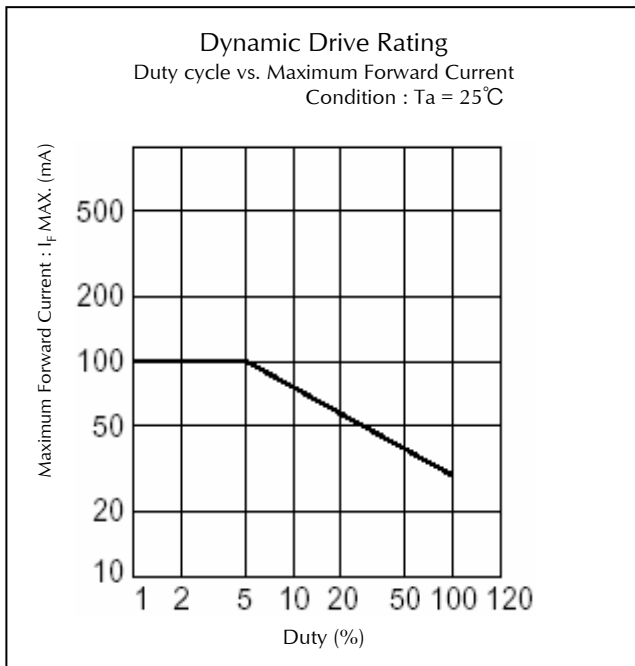

Technical Data(BR)

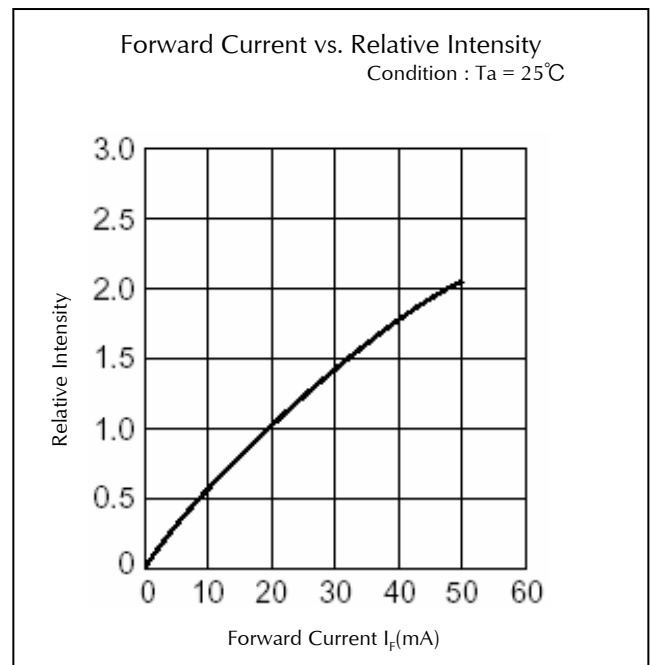
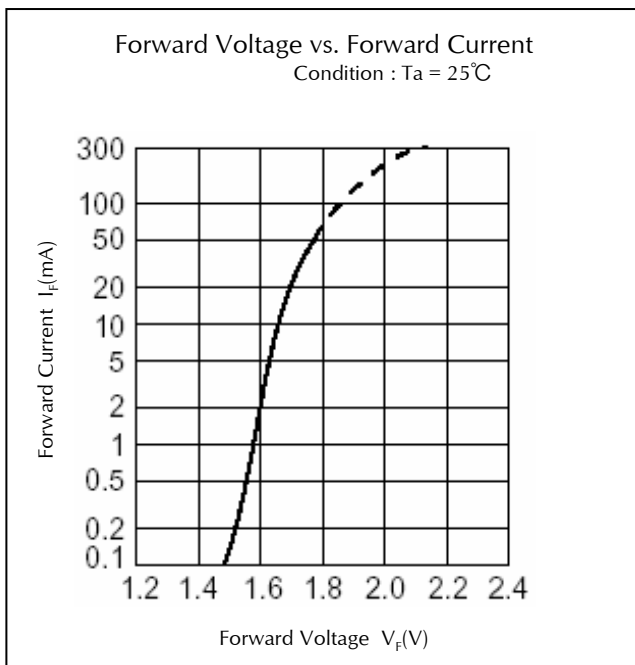
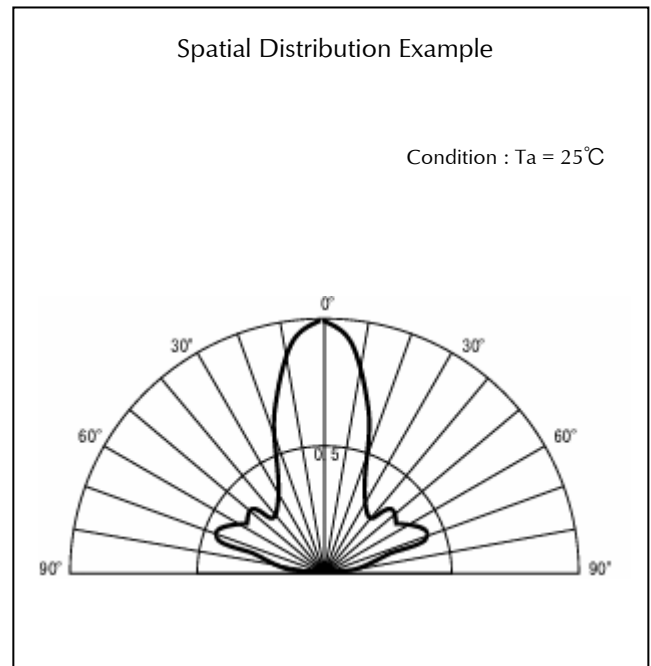
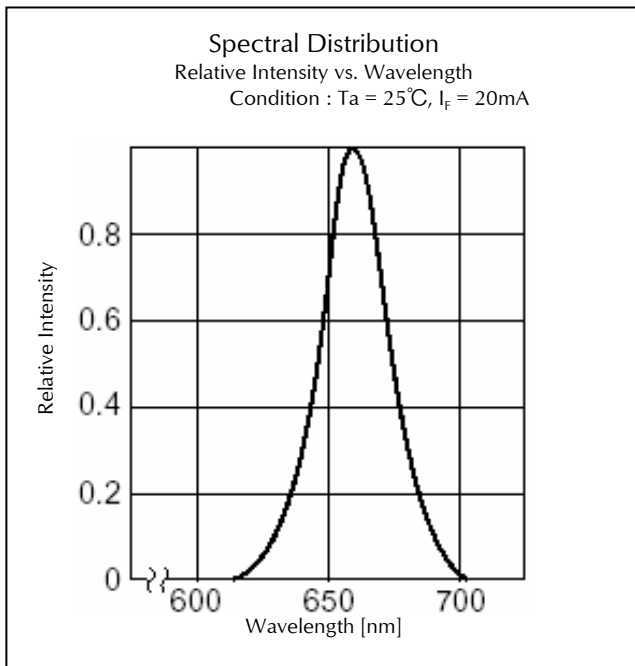

Technical Data(BR)

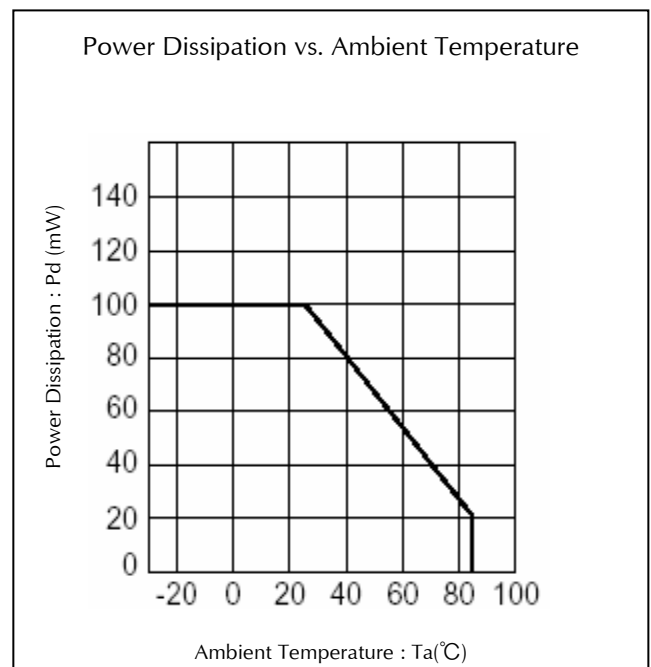
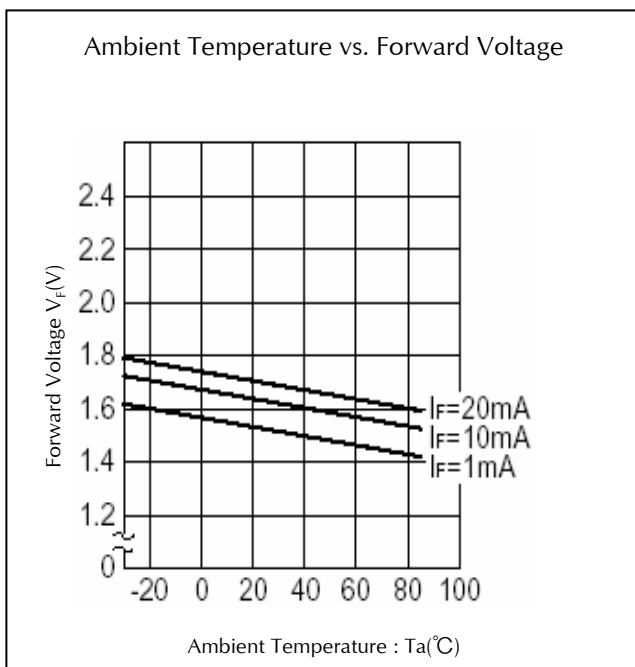
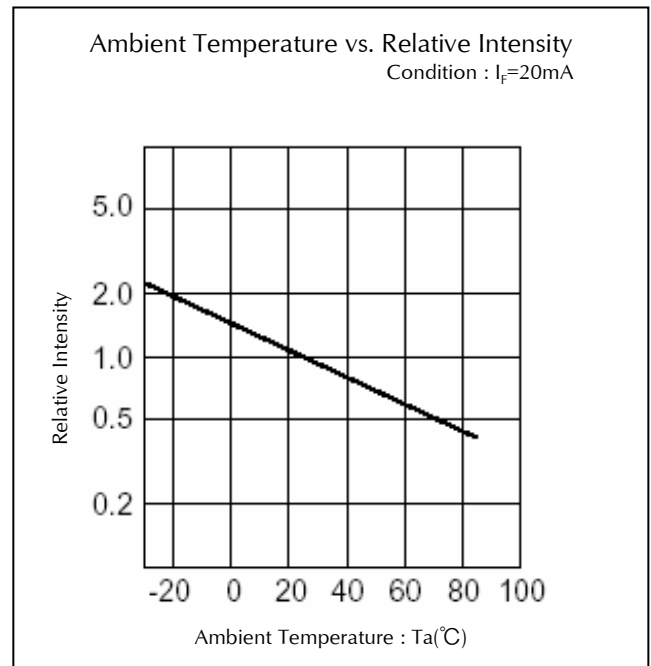
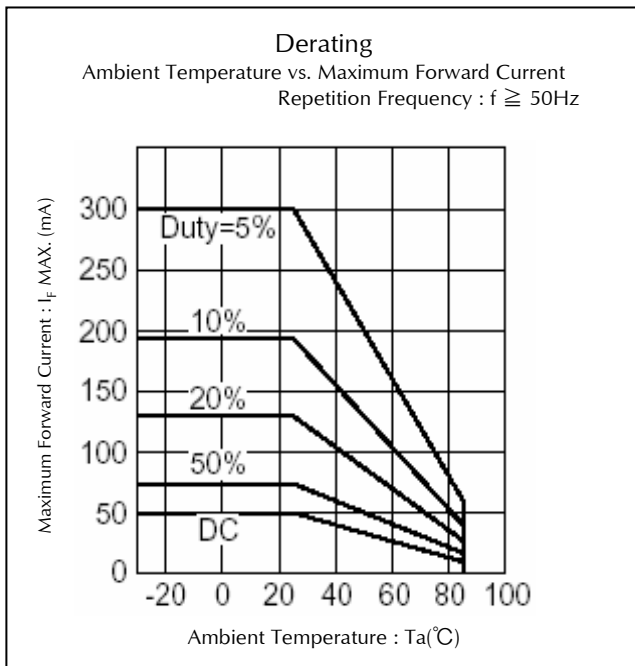

Technical Data(BR)

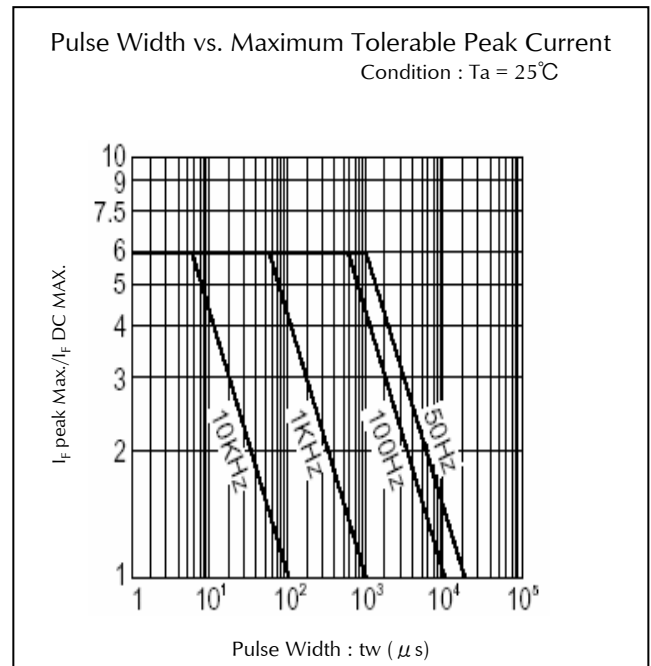
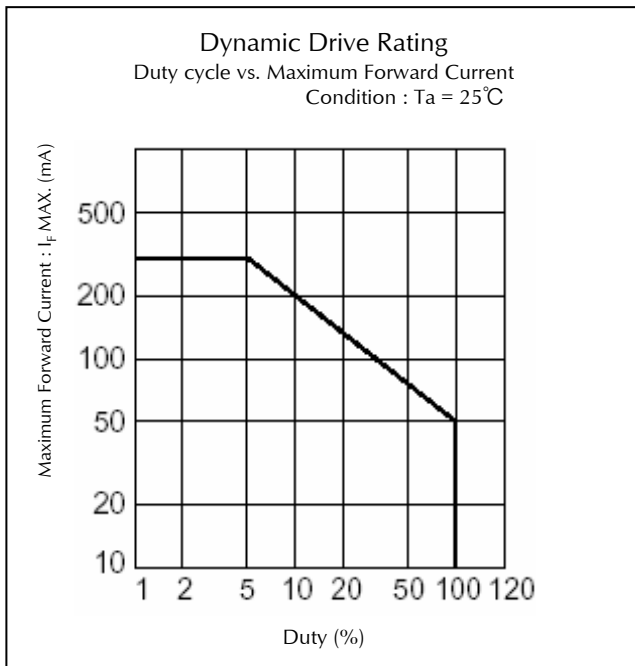

Technical Data(PR)

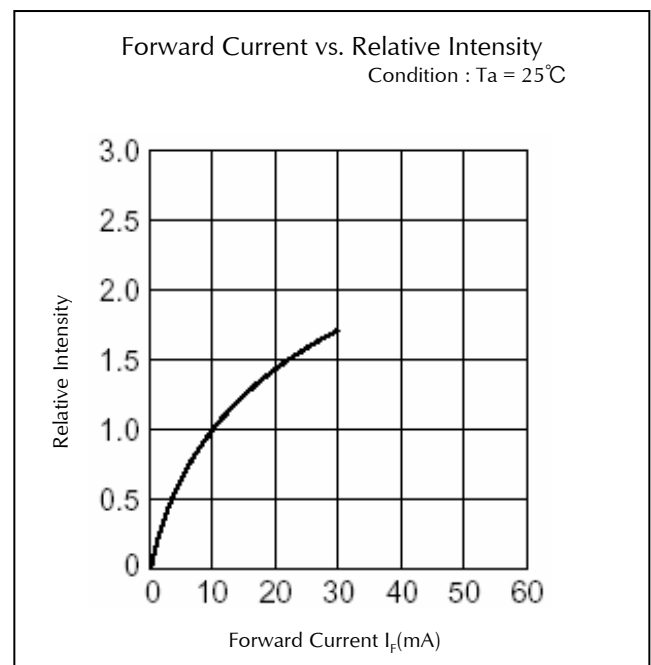
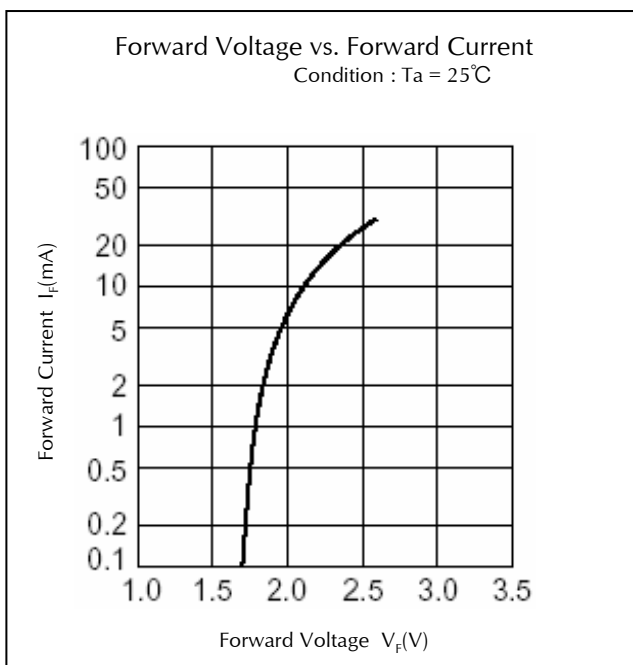
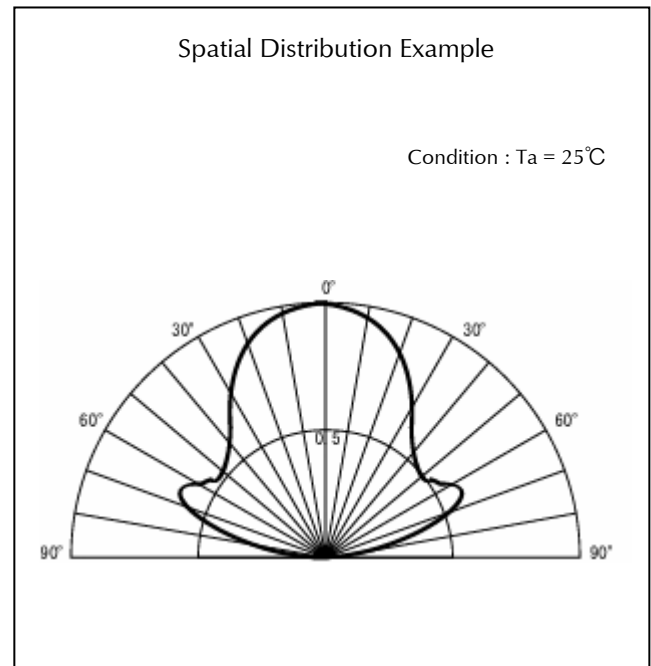
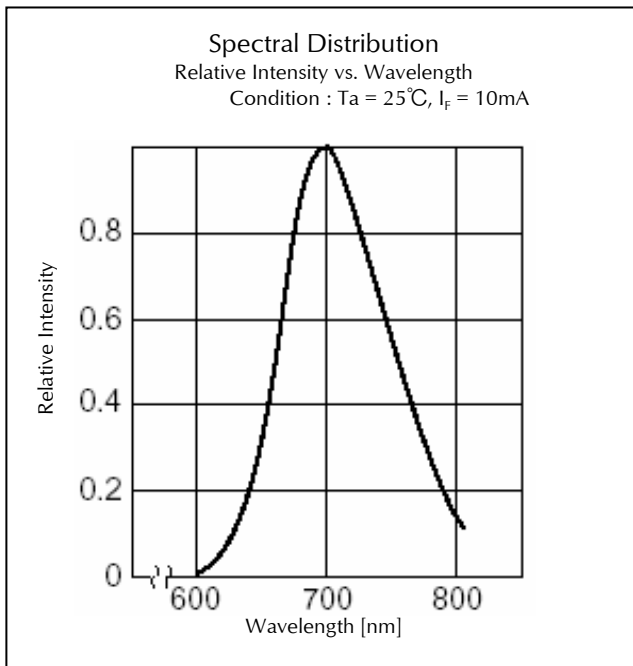

Technical Data(PR)

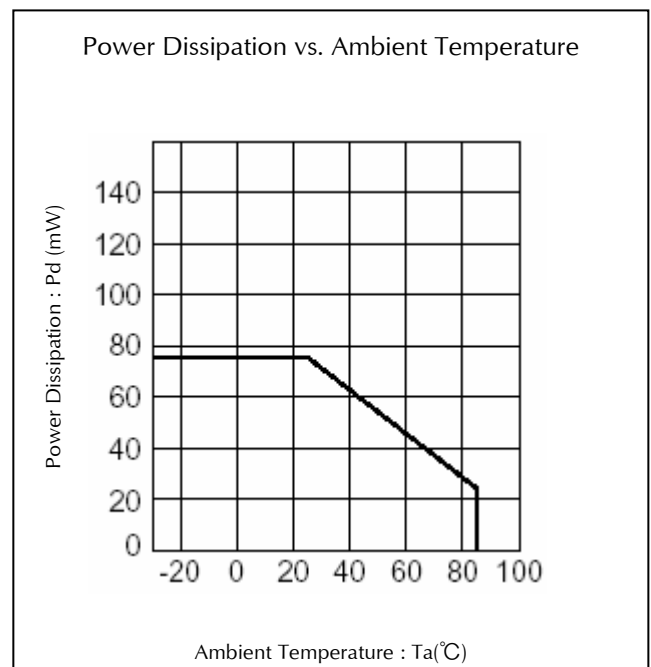
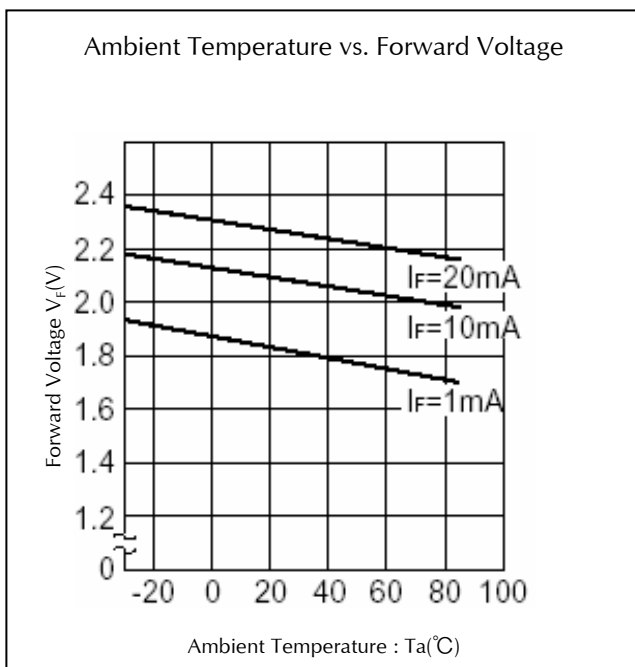
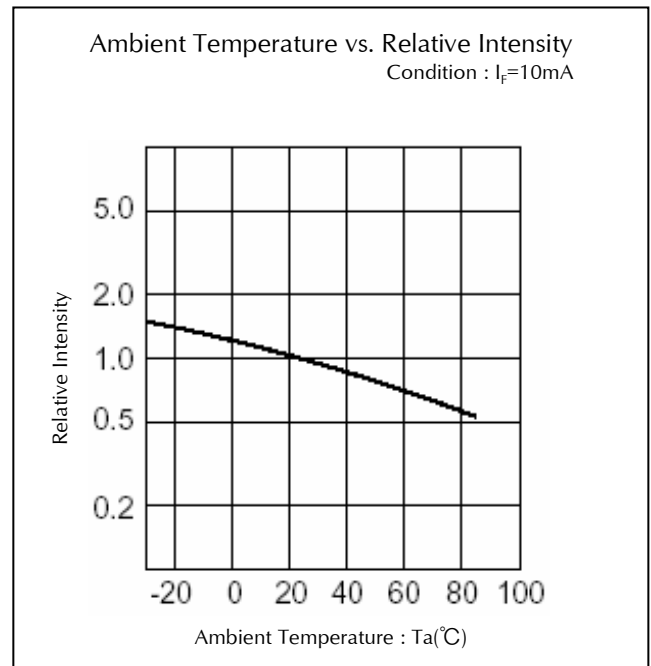
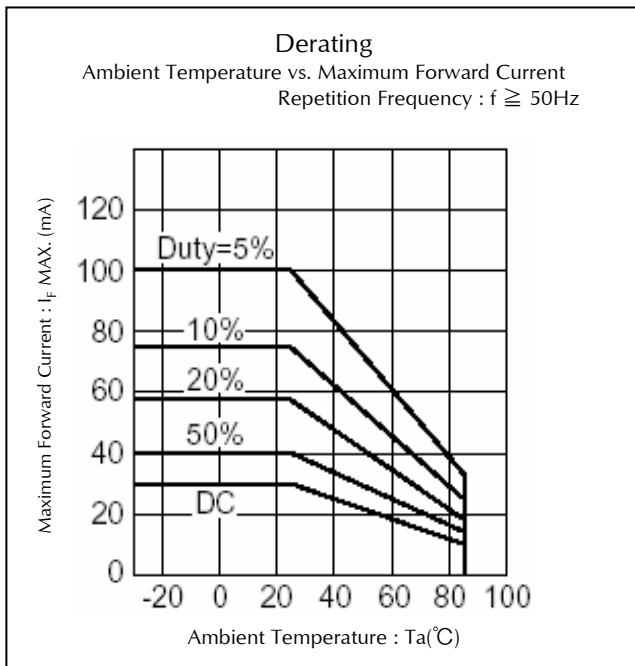

Technical Data(PR)

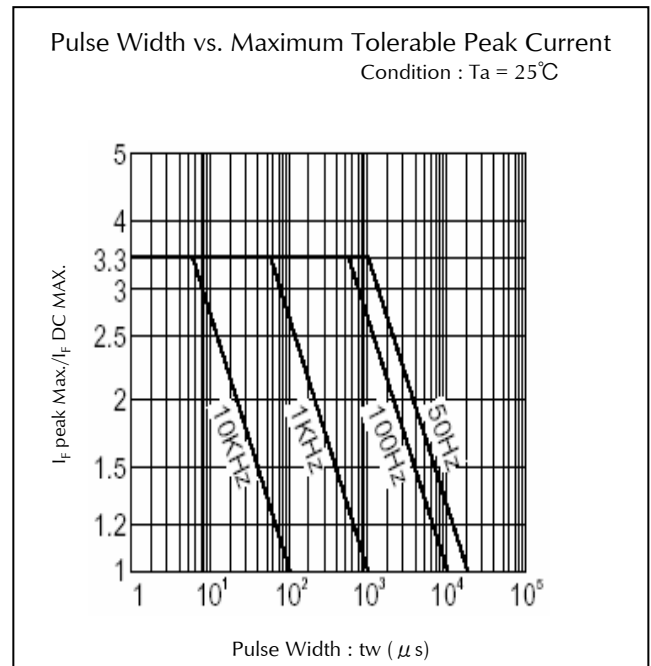
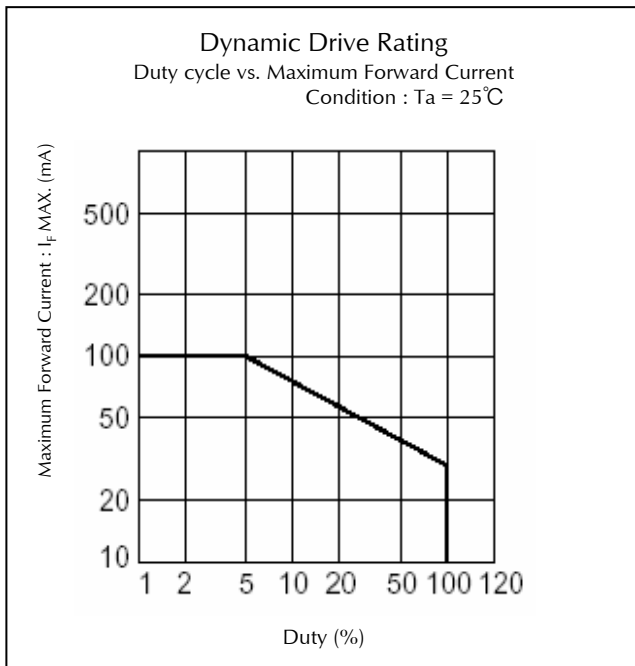

Package Dimensions

(Unit: mm)

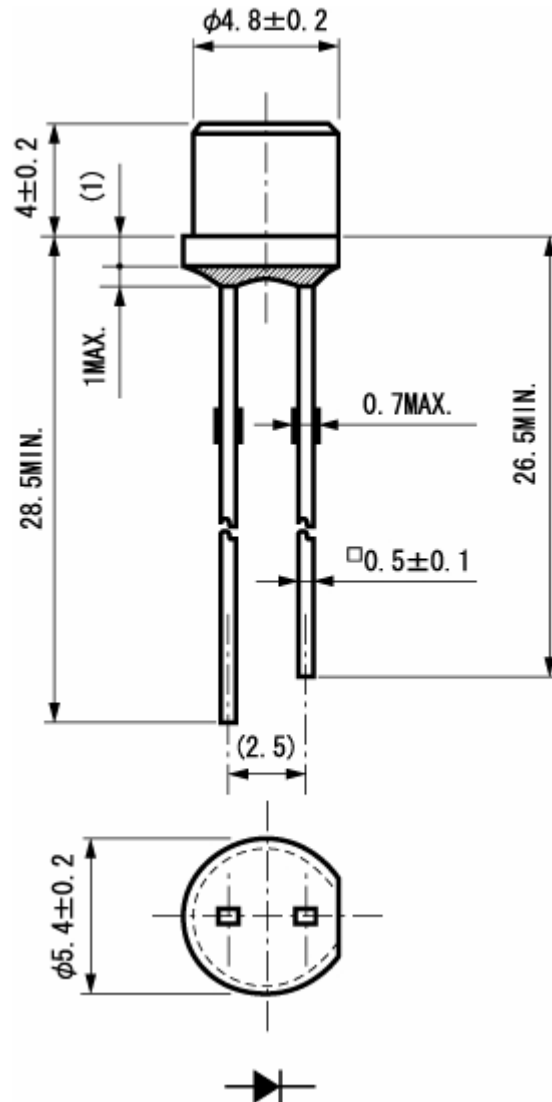

TTW (Through The Wave) soldering Conditions

Pre-heating	100 °C	(MAX.)
Solder Bath Temp.	265°C	(MAX.)
Dipping Time	5 s	(MAX.)

- 1) The dip soldering process shall be 2 times maximum.
- 2) The product shall be cooled to room temp. before the second dipping process.

※The detail is described to LED and Photodetector handling precautions of home page:
 "Mounting through-hole Type Devices" and "Soldering", and use it after the confirmation, please.

Manual Soldering Conditions

Iron tip temp.	400°C	(MAX.)
Soldering time and frequency	3 s	(MAX.)
	2 times	(MAX.)

※The detail is described to LED and Photodetector handling precautions of home page:
 "Mounting through-hole Type Devices" and "Soldering", and use it after the confirmation, please.

Reliability Testing Result

Reliability Testing Result	Applicable Standard	Testing Conditions	Duration	Failure
Room Temp. Operating Life	EIAJ ED-4701/100(101)	Ta = 25°C, If = Maximum Rated Current	1,000 h	0/25
Resistance to Soldering Heat	EIAJ ED-4701/300(302)	260±5°C, 3mm from package base	10sec	0/25
Temperature Cycling	EIAJ ED-4701/100(105)	Minimum Rated Storage Temperature(30min) ~Normal Temperature(15min) ~Maximum Rated Storage Temperature(30min) ~Normal Temperature(15min)	5 cycles	0/25
Wet High Temp. Storage Life	EIAJ ED-4701/100(103)	Ta = 60±2°C, RH = 90±5%	1,000 h	0/25
High Temp. Storage Life	EIAJ ED-4701/200(201)	Ta = Maximum Rated Storage Temperature	1,000 h	0/25
Low Temp. Storage Life	EIAJ ED-4701/200(202)	Ta = Minimum Rated Storage Temperature	1,000 h	0/25
Lead Tension	EIAJ ED-4701/400(401)	10N, 1time (□0.4 and Flat Package : 5N)	10sec	0/10
Vibration, Variable Frequency	EIAJ ED-4701/400(403)	98.1m/s ² (10G), 100 ~ 2KHz sweep for 20min., XYZ each direction	2 h	0/10

Failure Criteria

Items	Symbols	Conditions	Failure criteria
Luminous Intensity	Iv	If Value of each product Luminous Intensity	Testing Min. Value < Spec. Min. Value x 0.5
Forward Voltage	V _F	If Value of each product Forward Voltage	Testing Max. Value ≥ Spec. Max. Value x 1.2
Reverse Current	I _R	V _R = Maximum Rated Reverse Voltage V	Testing Max. Value ≥ Spec. Max. Value x 2.5
Cosmetic Appearance	-	-	No notable, decoloration, deformation and cracking

Special Notice to Customers Using the Products and Technical Information Shown in This Data Sheet

- 1) The technical information shown in the data sheets are limited to the typical characteristics and circuit examples of the referenced products. It does not constitute the warranting of industrial property nor the granting of any license.
- 2) For the purpose of product improvement, the specifications, characteristics and technical data described in the data sheets are subject to change without prior notice. Therefore it is recommended that the most updated specifications be used in your design.
- 3) When using the products described in the data sheets, please adhere to the maximum ratings for operating voltage, heat dissipation characteristics, and other precautions for use. We are not responsible for any damage which may occur if these specifications are exceeded.
- 4) The products described in the data sheets are made to be used in standard electronic applications such as office automation appliances, communication devices, audio visual, home appliances, and measuring instruments.
- 5) If the products in the data sheets are to be used for purposes other than the above which requires high level reliability and safety where failure and or malfunction of the product may cause death or other serious effects on the human body such as airplane, space activity, transportation, medical, nuclear), please contact our sales personnel.
- 6) In order to export the products or technologies described in this data sheet which are under the "Foreign Exchange and Foreign Trade Control Law," it is necessary to first obtain an export permit from the Japanese government.
- 7) No part of this data sheet may be reprinted or reproduced without prior written permission from Stanley Electric Co., Ltd.
- 8) The most updated edition of this data sheet can be obtained from the address below:
<http://www.stanley-components.com>