



BIPOLAR DIGITAL INTEGRATED CIRCUIT

UPB1509GV

NEC's 1.0 GHz DIVIDE BY 2/4/8 PRESCALER

FEATURES

- HIGH FREQUENCY OPERATION TO 1 GHz
- SELECTABLE DIVIDE RATIO: $\div 2$, $\div 4$, $\div 8$
- WIDE SUPPLY VOLTAGE RANGE: 2.2 TO 5 V
- LOW SUPPLY CURRENT: 5.3 mA
- SMALL PACKAGE: 8 pin SSOP
- AVAILABLE IN TAPE AND REEL

DESCRIPTION

NEC's UPB1509GV is a Silicon RFIC digital prescaler manufactured with the NESAT™ IV silicon bipolar process. It features frequency response to 1 GHz, selectable divide-by-two, four, or eight modes, and operates from a 3 to 5 volt supply while drawing only 5.3 milliamps. The device is housed in a small 8 pin SSOP package that contributes to system miniaturization. The low power consumption and wide supply range makes the device well suited for cellular and cordless telephones as well as DBS receiver applications.

TEST CIRCUIT

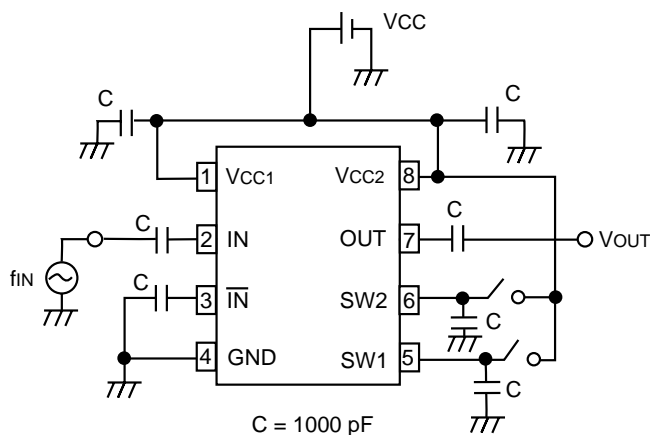

ELECTRICAL CHARACTERISTICS (T_A = -40 to +85°C, V_{CC} = 2.2 to 5.5 V, unless otherwise noted)

| PART NUMBER PACKAGE OUTLINE | | | UPB1509GV S08 | | |
|--------------------------------|--|--------------------------|---------------------------|-----------------|-----------|
| SYMBOLS | PARAMETERS AND CONDITIONS | UNITS | MIN | TYP | MAX |
| I _{CC} | Supply Current, No Input Signal, V _{CC} = 3 V | mA | 3.5 | 5.0 | 5.9 |
| f _{IN} (u) | Upper Limit Operating Frequency, P _{IN} = -20 to 0 dBm P _{IN} = -20 to -5 dBm at $\div 2$ at $\div 4$ at $\div 8$ | MHz MHz MHz MHz | 500 700 800 1000 | | |
| f _{IN} (L) | Lower Limit Operating Frequency, P _{IN} = -20 to 0 dBm P _{IN} = -20 to -5 dBm | MHz MHz | | | 50 500 |
| P _{IN} | Input Power, f _{IN} = 50 to 1000 MHz f _{IN} = 50 to 500 MHz | dBm dBm | -20 -20 | | -5 0 |
| V _{OUT} | Output Voltage, R _L = 200 Ω | V _{P-P} | 0.1 | 0.2 | |
| V _{IN(H)} | Division Ratio Control Voltage High | V | | V _{CC} | |
| V _{IN(L)} | Division Ratio Control Voltage Low | V | | OPEN | |

The information in this document is subject to change without notice. Before using this document, please confirm that this is the latest version.

ABSOLUTE MAXIMUM RATINGS¹ (T_A = 25°C)

| SYMBOLS | PARAMETERS | UNITS | RATINGS |
|-------------------------------------|--------------------------------|-------|-------------|
| V _{CC1} , V _{CC2} | Supply Voltage | V | 6.0 |
| V _{IN} | Input Voltage | V | 6.0 |
| P _D | Power Dissipation ² | mW | 250 |
| T _{OP} | Operating Temperature | °C | -45 to +85 |
| T _{STG} | Storage Temperature | °C | -55 to +150 |

Notes:

1. Operation in excess of any one of these parameters may result in permanent damage.
2. Mounted on a double-sided copper clad 50x50x1.6 mm epoxy glass PWB (T_A = +85°C).

RECOMMENDED OPERATING CONDITIONS

| SYMBOL | PARAMETER | UNITS | MIN | TYP | MAX |
|-------------------------------------|-----------------------|-------|-----|-----|-----|
| V _{CC1} , V _{CC2} | Supply Voltage | V | 2.2 | 3.0 | 5.5 |
| T _{OP} | Operating Temperature | °C | -40 | +25 | +85 |

INTERNAL BLOCK DIAGRAM

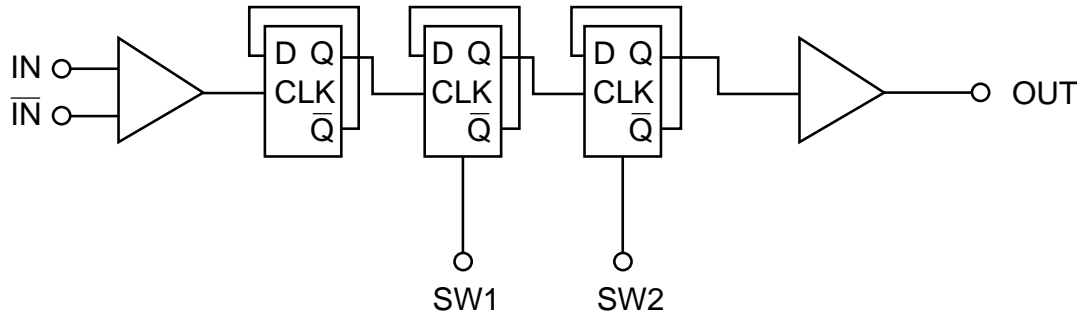

PIN DESCRIPTIONS

| Pin No. | Symbol | Applied Voltage | Pin Voltage | Description | | | | | | | | | | | | | |
|---------|------------------------|-----------------|-------------|--|--|--|-----|--|---------|----------|-----|---------|-----|-----|----------|-----|-----|
| 1 | VCC1 | 2.2 to 5.5 | – | Power supply pin of input amplifier and dividers. This pin must be equipped with bypass capacitor (eg 1000 pF) to ground. | | | | | | | | | | | | | |
| 2 | IN | – | 1.7 to 4.95 | Signal input pin. This pin should be coupled with a capacitor (eg 1000 pF). | | | | | | | | | | | | | |
| 3 | $\overline{\text{IN}}$ | – | 1.7 to 4.95 | Signal input bypass pin. This pin must be equipped with a bypass capacitor (eg 1000 pF) to ground. | | | | | | | | | | | | | |
| 4 | GND | 0 | – | Ground pin. Ground pattern on the board should be formed as wide as possible to minimize ground impedance. | | | | | | | | | | | | | |
| 5 | SW1 | H/L (VCC/OPEN) | – | Divided ratio control pin. Divide ratio can be controlled by the following input voltages to these pins. <table border="1" style="margin: 10px auto;"> <thead> <tr> <th colspan="2" rowspan="2"></th> <th colspan="2">SW2</th> </tr> <tr> <th>H (Vcc)</th> <th>L (OPEN)</th> </tr> </thead> <tbody> <tr> <th rowspan="2">SW1</th> <th>H (Vcc)</th> <td>1/2</td> <td>1/4</td> </tr> <tr> <th>L (OPEN)</th> <td>1/4</td> <td>1/8</td> </tr> </tbody> </table> | | | SW2 | | H (Vcc) | L (OPEN) | SW1 | H (Vcc) | 1/2 | 1/4 | L (OPEN) | 1/4 | 1/8 |
| | | SW2 | | | | | | | | | | | | | | | |
| | | H (Vcc) | L (OPEN) | | | | | | | | | | | | | | |
| SW1 | H (Vcc) | 1/2 | 1/4 | | | | | | | | | | | | | | |
| | L (OPEN) | 1/4 | 1/8 | | | | | | | | | | | | | | |
| 6 | SW2 | H/L (VCC/OPEN) | – | These pins must each be equipped with a bypass capacitor to ground. | | | | | | | | | | | | | |
| 7 | OUT | – | 1.0 to 4.7 | Divided frequency output pin. This pin is designed as an emitter follower output. This pin can output 0.1 V _{p-p} min with a 200 Ω load. This pin should be coupled to load device with a capacitor (eg 1000 pF). | | | | | | | | | | | | | |
| 8 | VCC2 | 2.2 to 5.5 | – | Power supply pin of output buffer amplifier. This pin must be equipped with bypass capacitor (eg 1000 pF) to ground. | | | | | | | | | | | | | |

TYPICAL PERFORMANCE CURVES

($T_A = +25^\circ\text{C}$ unless otherwise noted)

CIRCUIT CURRENT vs. SUPPLY VOLTAGE and TEMPERATURE

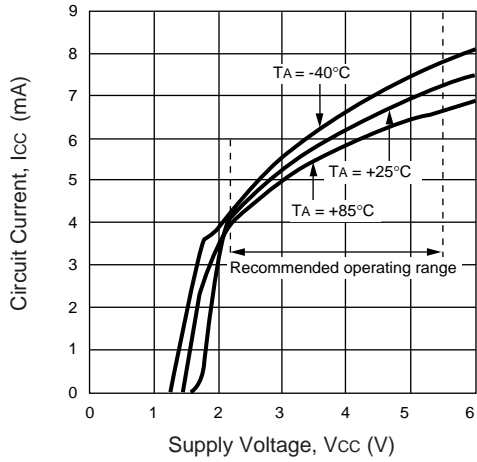

INPUT POWER vs. INPUT FREQUENCY and VOLTAGE

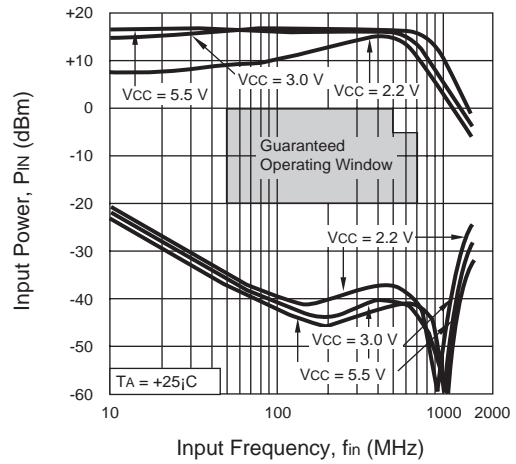

INPUT POWER vs. INPUT FREQUENCY and TEMPERATURE

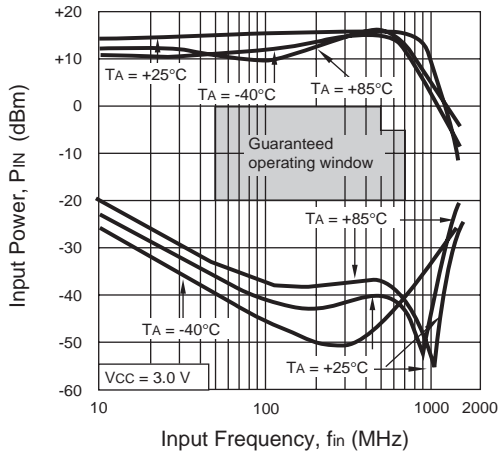

INPUT POWER vs. INPUT FREQUENCY and TEMPERATURE

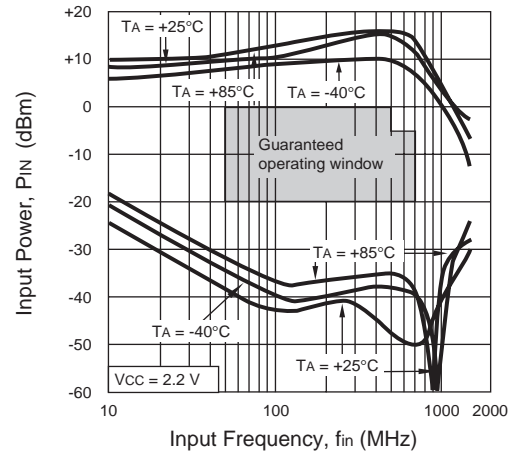

INPUT POWER vs. INPUT FREQUENCY and TEMPERATURE

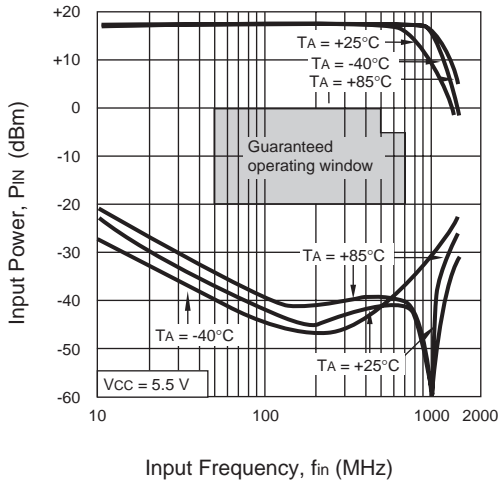

OUTPUT VOLTAGE SWING vs. INPUT FREQUENCY and VOLTAGE

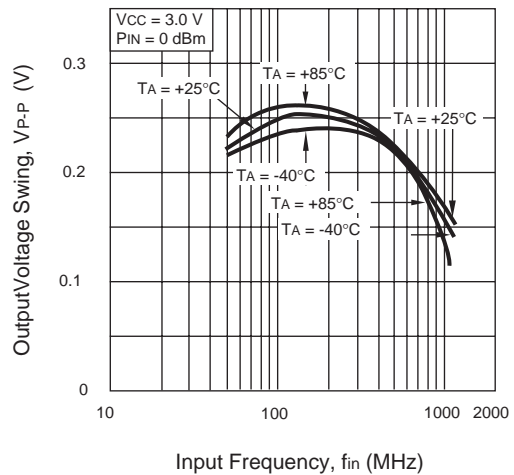

TYPICAL PERFORMANCE CURVES

(TA = +25°C unless otherwise noted)

OUTPUT VOLTAGE SWING vs. INPUT FREQUENCY and VOLTAGE

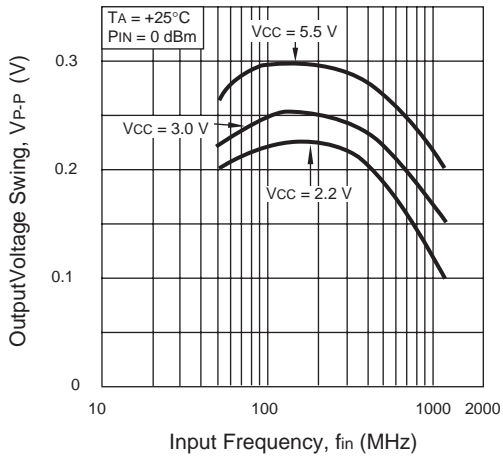

OUTPUT VOLTAGE SWING vs. INPUT FREQUENCY and VOLTAGE

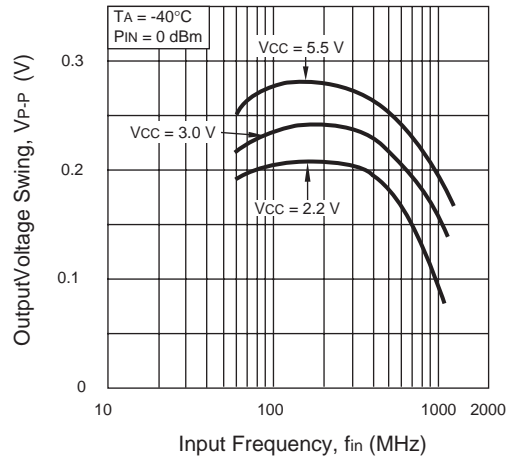

OUTPUT VOLTAGE SWING vs. INPUT FREQUENCY and VOLTAGE

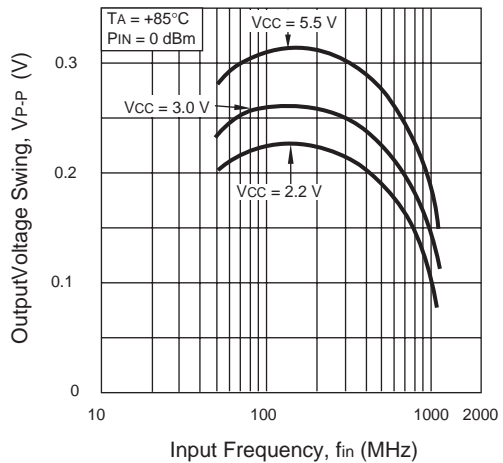

Divide by 4 mode

(Guaranteed operating window: VCC = 2.2 to 5.5 V, TA = -40 to +85°C)

INPUT POWER vs. INPUT FREQUENCY and VOLTAGE

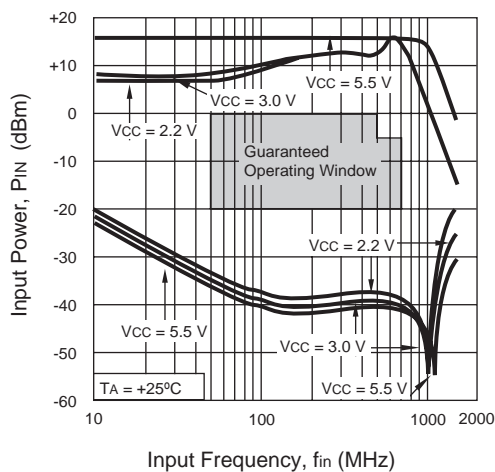

INPUT POWER vs. INPUT FREQUENCY and TEMPERATURE

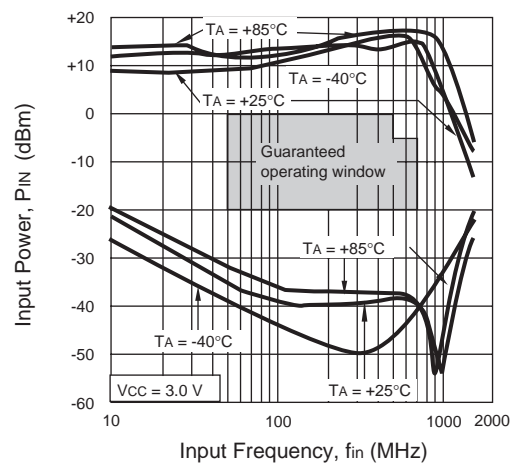

TYPICAL PERFORMANCE CURVES

(TA = +25°C unless otherwise noted)

INPUT POWER vs. INPUT FREQUENCY and TEMPERATURE

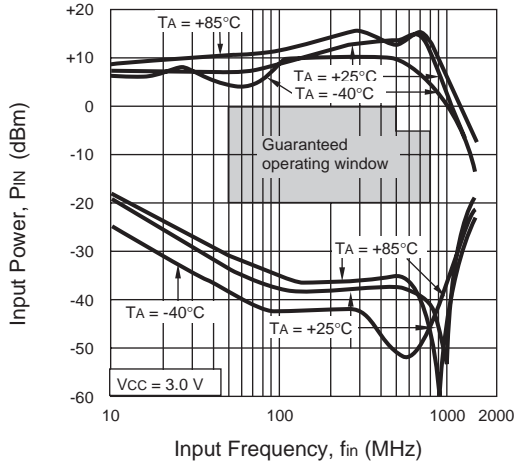

INPUT POWER vs. INPUT FREQUENCY and TEMPERATURE

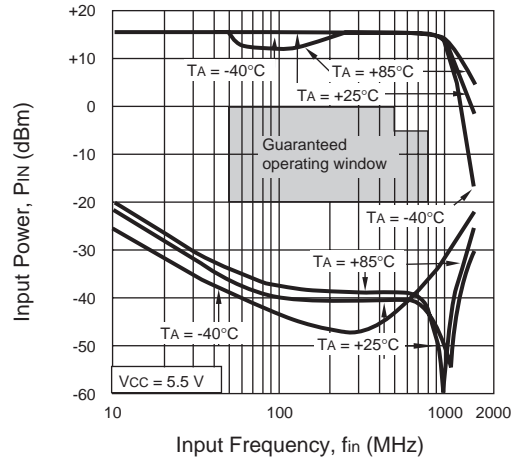

Divide by 8 mode

(Guaranteed operating window: VCC = 2.2 to 5.5 V, TA = -40 to +85 °C)

INPUT POWER vs. INPUT FREQUENCY and VOLTAGE

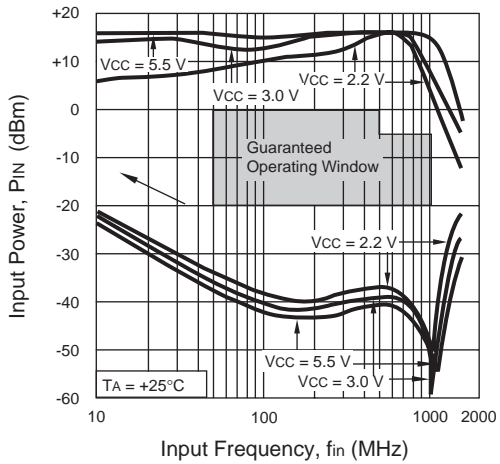

INPUT POWER vs. INPUT FREQUENCY and TEMPERATURE

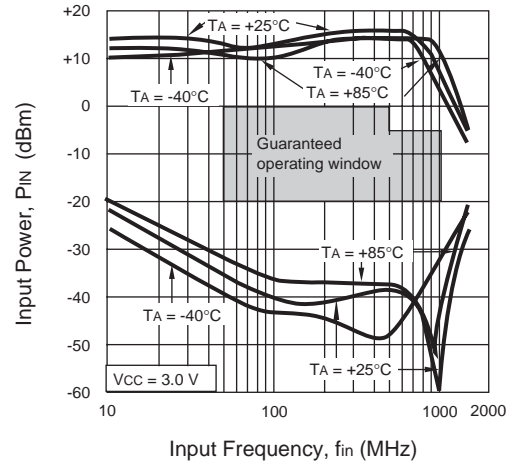

INPUT POWER vs. INPUT FREQUENCY and TEMPERATURE

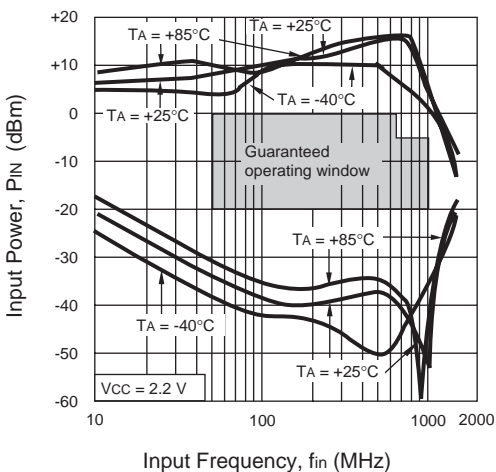

INPUT POWER vs. INPUT FREQUENCY and TEMPERATURE

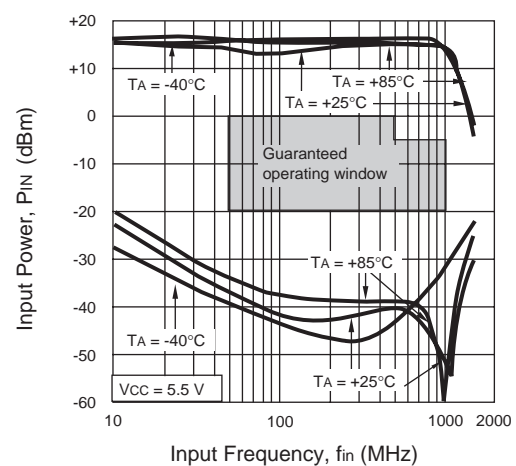

TYPICAL SCATTERING PARAMETERS ($T_A = 25^\circ\text{C}$)

S11 vs. INPUT FREQUENCY

$V_{CC1} = V_{CC2} = 3.0\text{ V}$, $SW1 = SW2 = 3.0\text{ V}$

S11
 REF 1.0 Units/
 2 200.0 mUnits/
 ▽ 55.375 Ω -142.79 Ω

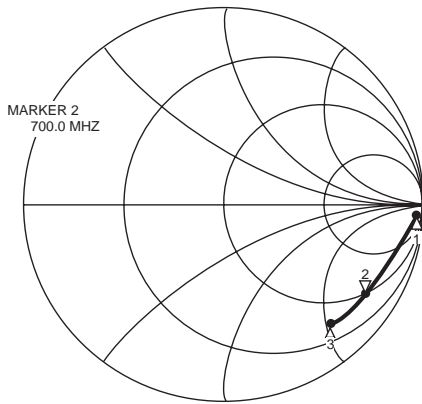

START 0.050000000 GHz
 STOP 1.000000000 GHz

| FREQUENCY | | S11 | |
|-----------|-------|-------|--|
| GHz | MAG | ANG | |
| 0.1 | 0.929 | -6.7 | |
| 0.2 | 0.898 | -10.5 | |
| 0.3 | 0.866 | -13.6 | |
| 0.4 | 0.840 | -15.9 | |
| 0.5 | 0.834 | -19.1 | |
| 0.6 | 0.819 | -21.9 | |
| 0.7 | 0.803 | -24.7 | |
| 0.8 | 0.792 | -27.0 | |
| 0.9 | 0.787 | -30.0 | |
| 1.0 | 0.771 | -32.7 | |

S22 vs. OUTPUT FREQUENCY

S22
 REF 1.0 Units
 200.0 mUnits/

Z
 50 MHz
 149.09 Ω + j 14.86 Ω
 350 MHz
 194.21 Ω - j 36.64 Ω

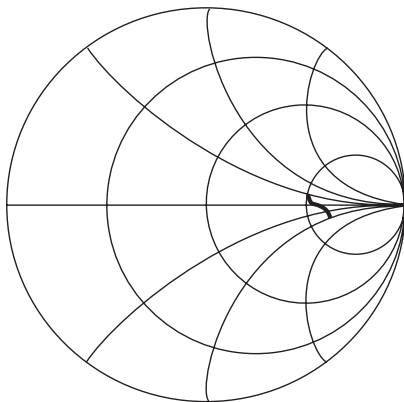

START 0.050000000 GHz
 STOP 0.350000000 GHz

SYSTEM APPLICATION EXAMPLE

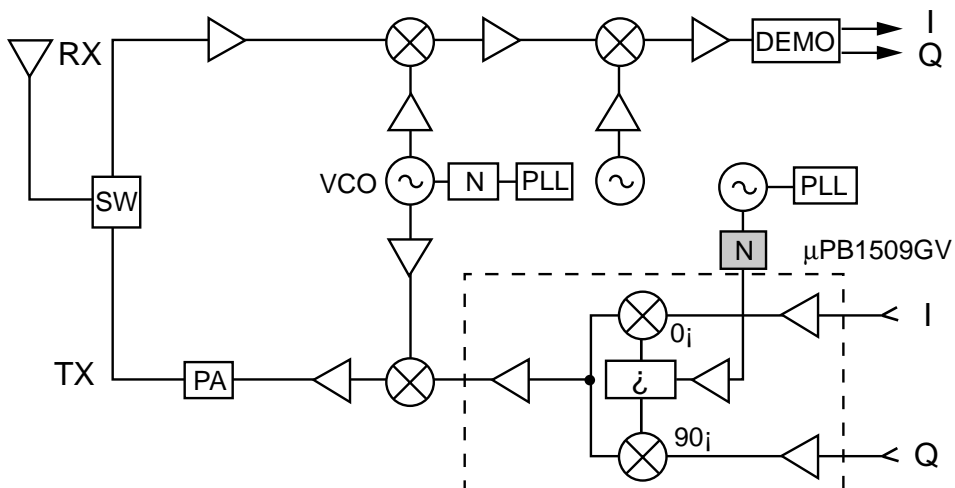

OUTLINE DIMENSIONS (Units in mm)

PACKAGE OUTLINE S08

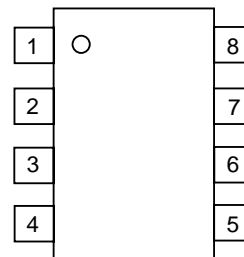
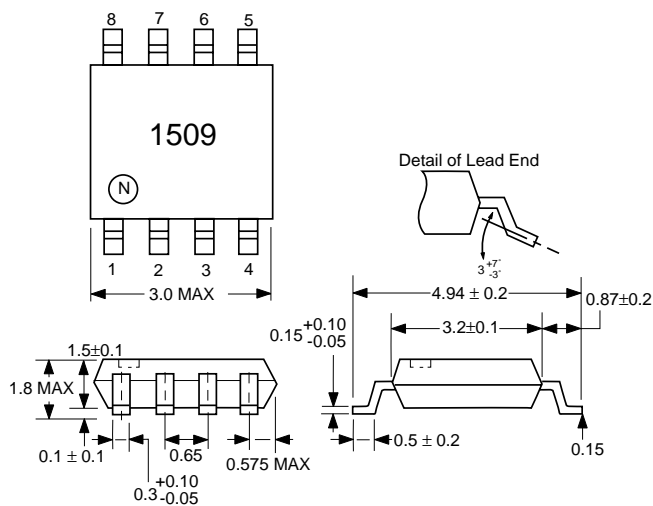

PIN CONNECTIONS

- 1. Vcc1
- 2. IN
- 3. IN-bar
- 4. GND
- 5. SW1
- 6. SW2
- 7. OUT
- 8. Vcc2

ORDERING INFORMATION (Solder Contains Lead)

| PART NUMBER | QUANTITY |
|--------------|-----------|
| UPB1509GV-E1 | 1000/Reel |

ORDERING INFORMATION (Pb-Free)

| PART NUMBER | QUANTITY |
|----------------|-----------|
| UPB1509GV-E1-A | 1000/Reel |

Life Support Applications

These NEC products are not intended for use in life support devices, appliances, or systems where the malfunction of these products can reasonably be expected to result in personal injury. The customers of CEL using or selling these products for use in such applications do so at their own risk and agree to fully indemnify CEL for all damages resulting from such improper use or sale.

CEL California Eastern Laboratories, Your source for NEC RF, Microwave, Optoelectronic, and Fiber Optic Semiconductor Devices.

4590 Patrick Henry Drive • Santa Clara, CA 95054-1817 • (408) 919-2500 • FAX (408) 988-0279 • www.cel.com

DATA SUBJECT TO CHANGE WITHOUT NOTICE

Subject: Compliance with EU Directives

CEL certifies, to its knowledge, that semiconductor and laser products detailed below are compliant with the requirements of European Union (EU) Directive 2002/95/EC Restriction on Use of Hazardous Substances in electrical and electronic equipment (RoHS) and the requirements of EU Directive 2003/11/EC Restriction on Penta and Octa BDE.

CEL Pb-free products have the same base part number with a suffix added. The suffix –A indicates that the device is Pb-free. The –AZ suffix is used to designate devices containing Pb which are exempted from the requirement of RoHS directive (*). In all cases the devices have Pb-free terminals. All devices with these suffixes meet the requirements of the RoHS directive.

This status is based on CEL’s understanding of the EU Directives and knowledge of the materials that go into its products as of the date of disclosure of this information.

| Restricted Substance per RoHS | Concentration Limit per RoHS (values are not yet fixed) | Concentration contained in CEL devices | |
|-------------------------------|---|--|-----|
| | | -A | -AZ |
| Lead (Pb) | < 1000 PPM | Not Detected | (*) |
| Mercury | < 1000 PPM | Not Detected | |
| Cadmium | < 100 PPM | Not Detected | |
| Hexavalent Chromium | < 1000 PPM | Not Detected | |
| PBB | < 1000 PPM | Not Detected | |
| PBDE | < 1000 PPM | Not Detected | |

If you should have any additional questions regarding our devices and compliance to environmental standards, please do not hesitate to contact your local representative.

Important Information and Disclaimer: Information provided by CEL on its website or in other communications concerning the substance content of its products represents knowledge and belief as of the date that it is provided. CEL bases its knowledge and belief on information provided by third parties and makes no representation or warranty as to the accuracy of such information. Efforts are underway to better integrate information from third parties. CEL has taken and continues to take reasonable steps to provide representative and accurate information but may not have conducted destructive testing or chemical analysis on incoming materials and chemicals. CEL and CEL suppliers consider certain information to be proprietary, and thus CAS numbers and other limited information may not be available for release.

In no event shall CEL’s liability arising out of such information exceed the total purchase price of the CEL part(s) at issue sold by CEL to customer on an annual basis.

See CEL Terms and Conditions for additional clarification of warranties and liability.