

Insulated Ultrafast Rectifier Module

Features

- Two Fully Independent Diodes
- Ceramic Fully Insulated Package ($V_{ISOL} = 2500V$ AC)
- Ultrafast Reverse Recovery
- Ultrasoft Reverse Recovery Current Shape
- Low Forward Voltage
- Optimized for Power Conversion: Welding and Industrial SMPS Applications
- Industry Standard Outline
- Plug-in Compatible with other SOT-227 Packages
- Easy to Assemble
- Direct Mounting to Heatsink

$$t_{rr} = 27ns$$

$$I_{F(AV)} = 60A$$

$$@ T_C = 100^{\circ}C$$

$$V_R = 200V$$

Description

The UFB60FA20 insulated modules integrate two state-of-the-art International Rectifier's Ultrafast recovery rectifiers in the compact, industry standard SOT-227 package. The planar structure of the diodes, and the platinum doping lifetime control, provide a Ultrasoft recovery current shape, together with the best overall performance, ruggedness and reliability characteristics.

These devices are thus intended for high frequency applications in which the switching energy is designed not to be predominant portion of the total energy, such as in the output rectification stage of Welding machines, SMPS, DC-DC converters. Their extremely optimized stored charge and low recovery current reduce both over dissipation in the switching elements (and snubbers) and EMI/ RFI.

Absolute Maximum Ratings

Parameters	Max	Units
V_R Cathode-to-Anode Voltage	200	V
I_F Continuous Forward Current, $T_C = 100^{\circ}C$ Per Diode	30	A
I_{FSM} Single Pulse Forward Current, $T_C = 25^{\circ}C$ Per Diode	250	A
P_D Max. Power Dissipation, $T_C = 100^{\circ}C$ Per Module	53	W
V_{ISOL} RMS Isolation Voltage, Any Terminal to Case, $t = 1$ min	2500	V
T_J, T_{STG} Operating Junction and Storage Temperatures	- 55 to 150	$^{\circ}C$

Case Styles

UFB60FA20

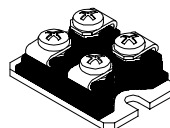

SOT-227

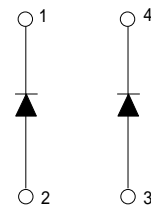

Electrical Characteristics @ T_J = 25°C (unless otherwise specified) per diode

Parameters		Min	Typ	Max	Units	Test Conditions
V _{BR}	Cathode Anode Breakdown Voltage	200	-	-	V	I _R = 100μA
V _{FM}	Forward Voltage	-	0.96	1.08	V	I _F = 30A
		-	0.78	0.86	V	I _F = 30A, T _J = 150°C
I _{RM}	Reverse Leakage Current	-	-	100	μA	V _R = V _R Rated
		-	-	1.0	mA	T _J = 150°C, V _R = V _R Rated
C _T	Junction Capacitance	-	119	-	pF	V _R = 200V

Dynamic Recovery Characteristics @ T_J = 25°C (unless otherwise specified) per diode

Parameters		Min	Typ	Max	Units	Test Conditions	
t _{rr}	Reverse Recovery Time	-	-	27	ns	I _F = 1.0A, di _F /dt = 200A/μs, V _R = 30V	
		-	31	-		T _J = 25°C	I _F = 30A V _R = 100V di _F /dt = 200A/μs
		-	51	-		T _J = 125°C	
I _{RRM}	Peak Recovery Current	-	2.7	-	A	T _J = 25°C	
		-	6.8	-		T _J = 125°C	
Q _{rr}	Reverse Recovery Charge	-	41	-	nC	T _J = 25°C	
		-	174	-		T _J = 125°C	

Thermal - Mechanical Characteristics

Parameters		Min	Typ	Max	Units
R _{thJC}	Junction to Case, Single Leg Conducting	-	-	1.9	°C/W
	Both Leg Conducting	-	-	0.95	K/W
R _{thCS}	Case to Heat Sink, Flat, Greased Surface	-	0.05	-	
Wt	Weight	-	30	-	g
T	Mounting Torque	-	1.3	-	(N*m)

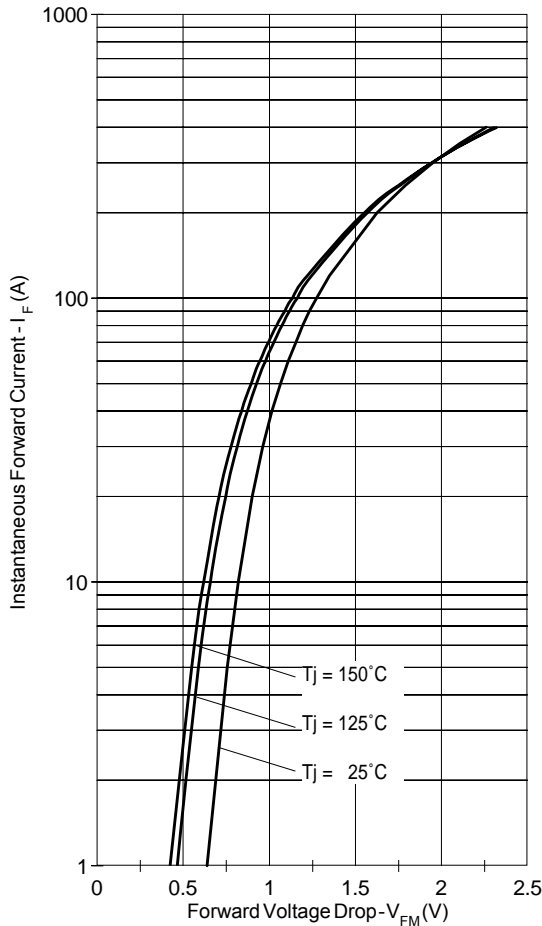

Fig. 1 - Typical Forward Voltage Drop Characteristics (per diode)

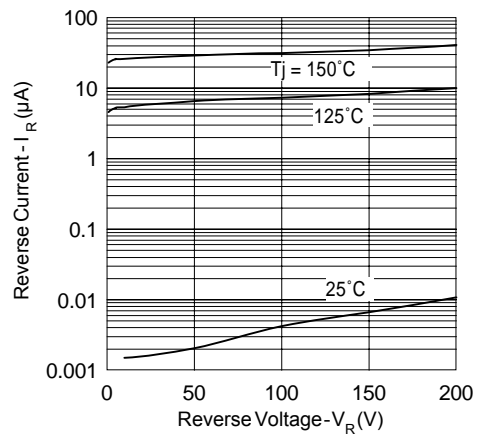

Fig. 2 - Typical Values Of Reverse Current Vs. Reverse Voltage

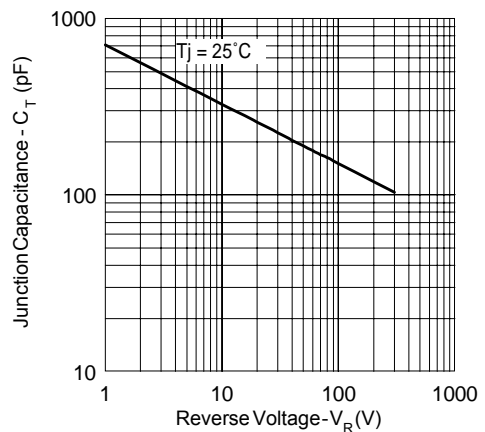

Fig. 3 - Typical Junction Capacitance Vs. Reverse Voltage

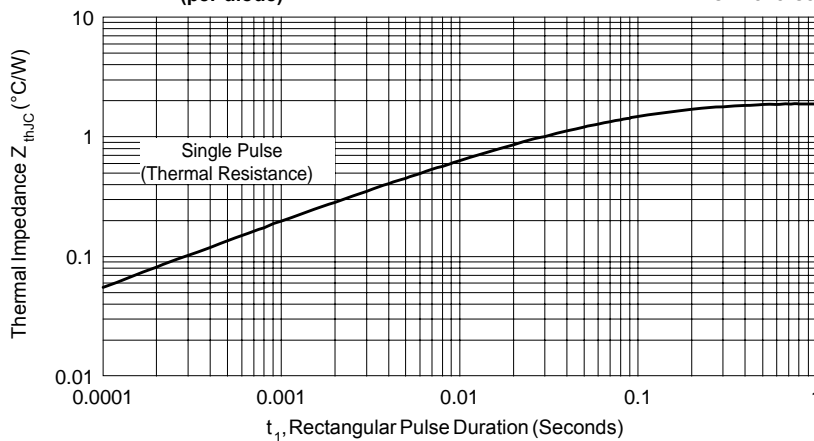

Fig. 4 - Max. Thermal Impedance Z_{thJC} Characteristics (per diode)

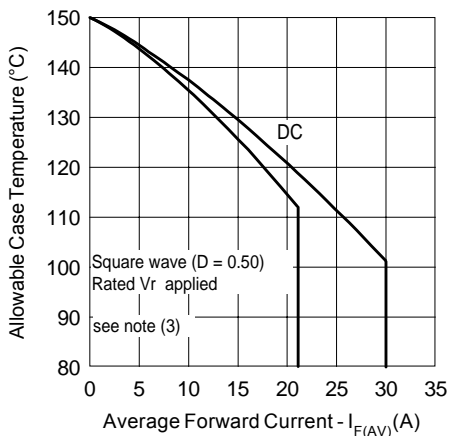

Fig. 5 - Max. Allowable Case Temperature Vs. Average Forward Current (per leg)

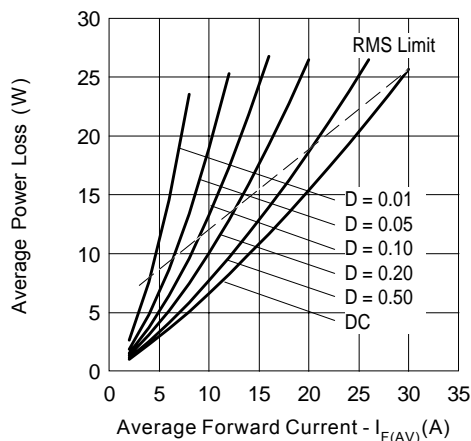

Fig. 6 - Forward Power Loss Characteristics (per leg)

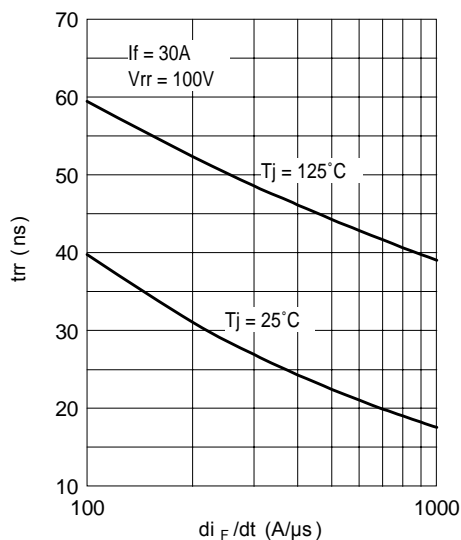

Fig. 7 - Typical Reverse Recovery time vs. di_F/dt

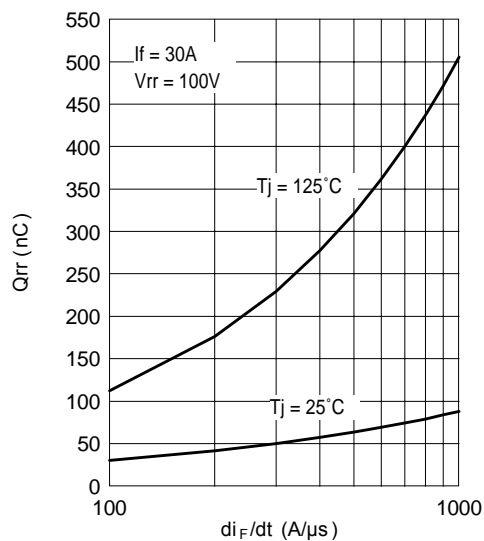

Fig. 8 - Typical Stored Charge vs. di_F/dt

(3) Formula used: $T_C = T_J - (P_d + P_{d_{REV}}) \times R_{thJC}$;
 $P_d = \text{Forward Power Loss} = I_{F(AV)} \times V_{FM} @ (I_{F(AV)} / D)$ (see Fig. 6);
 $P_{d_{REV}} = \text{Inverse Power Loss} = V_{R1} \times I_R (1 - D)$; $I_R @ V_{R1} = \text{rated } V_R$

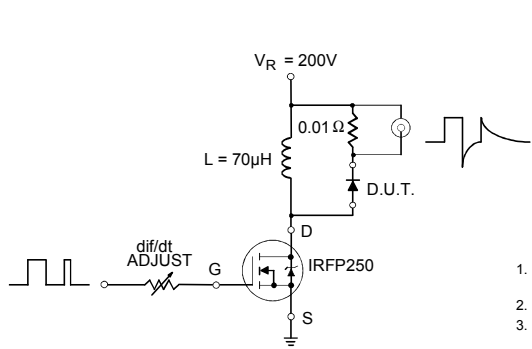
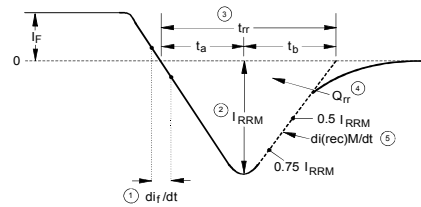

Fig. 9 - Reverse Recovery Parameter Test Circuit



1. di_f/dt - Rate of change of current through zero crossing
2. I_{RRM} - Peak reverse recovery current
3. t_{rr} - Reverse recovery time measured from zero crossing point of negative going I_F to point where a line passing through $0.75 I_{RRM}$ and $0.5 I_{RRM}$ extrapolated to zero current
4. Q_{rr} - Area under curve defined by t_{rr} and I_{RRM}

$$Q_{rr} = \frac{t_{rr} \times I_{RRM}}{2}$$
5. $di_{(rec)M}/dt$ - Peak rate of change of current during t_b portion of t_{rr}

Fig. 10 - Reverse Recovery Waveform and Definitions

SOT-227 Package Details

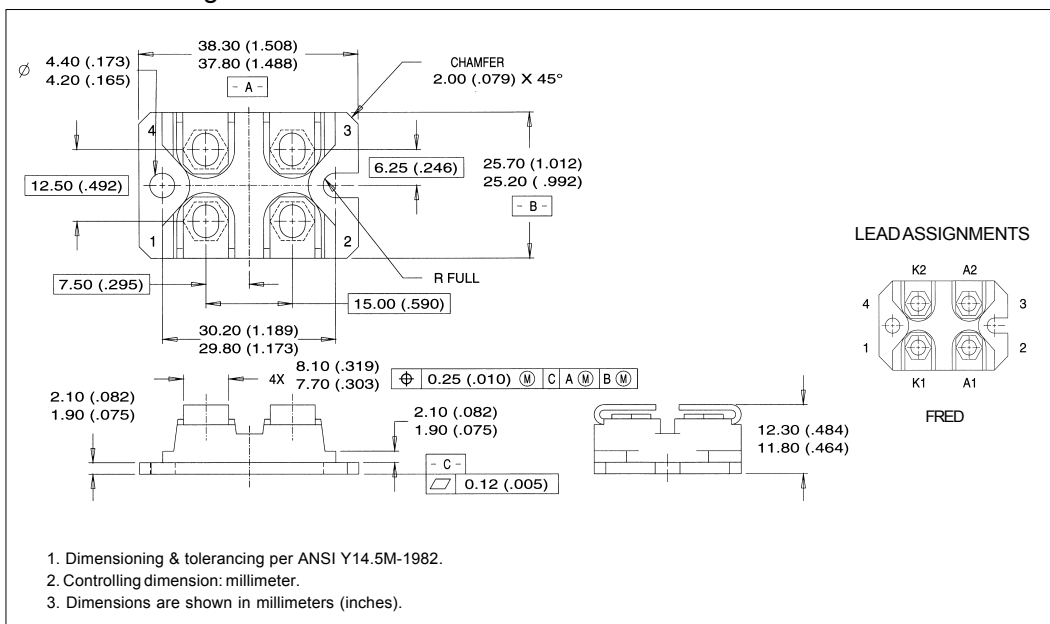

SOT-227 Package Details

Tube

QUANTITY PER TUBE IS 10
M4 SCREW AND WASHER INCLUDED

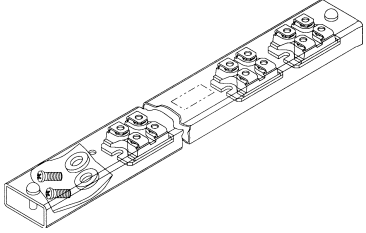

Ordering Information Table

Device Code

UF	B	60	F	A	20
①	②	③	④	⑤	⑥

- 1** - ULTRAFAST RECTIFIER
- 2** - Ultrafast Pt diffused
- 3** - Current Rating (60 = 60A)
- 4** - Circuit Configuration (2 separate Diodes, parallel pin-out)
- 5** - Package Indicator (SOT-227 Standard Isolated Base)
- 6** - Voltage Rating (20 = 200V)

Data and specifications subject to change without notice.
This product has been designed and qualified for Industrial Level.
Qualification Standards can be found on IR's Web site.