

Surface Mount Miniature Trimmers Single-Turn Cermet Sealed

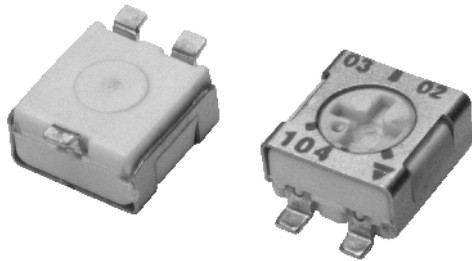

FEATURES

- 0.20 Watt at 85°C
- GAM T1
- For PCB version see T53Y series
- Excellent stability
- Wide ohmic range
- Low temperature coefficient
- Low contact resistance variation
- Small size for optimum packing density
- Suitable for both manual or automatic operation

The TS53 trimming potentiometer has been designed for surface mount applications and offers volumetric efficiency (5 x 5 x 2.7 mm) with high performance and stability.

The TS53 design is suitable for both manual or automatic operation, and can withstand waves, vapor phase and reflow soldering techniques.

DIMENSIONS in millimeters

TS53YL

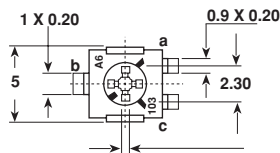
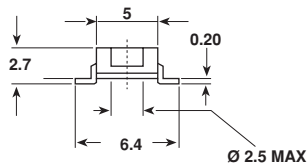

cruciform screwdriver slot
 ø 2.5, width 0.5
 deep: 0.55
 max deep (center): 0.7

RECOMMENDED SOLDERING AREAS

TS53YL

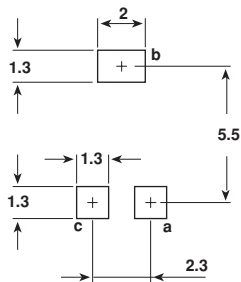

TS53YJ

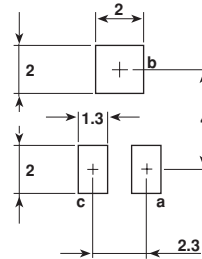

ADHESIVE PAD (detail)

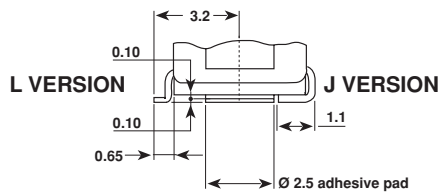

CIRCUIT DIAGRAM

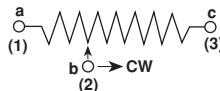

TS53YJ

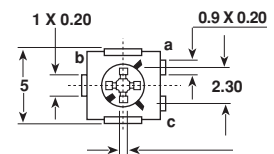
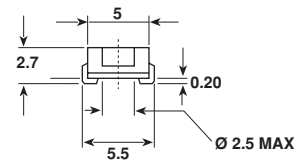

cruciform screwdriver slot
 ø 2.5, width 0.5
 deep: 0.55
 max deep (center): 0.7



ELECTRICAL SPECIFICATIONS		
Resistive Element		Cermet
Electrical Travel		220° ± 15°
Resistance Range		10Ω to 1MΩ
Standard Series		1 - 2 - 5
Tolerance Standard		± 20%
Power Rating	Linear	0.25W at 70°C
	Logarithmic	not applicable
Temperature Coefficient		See Standard Resistance Element Data
Limiting Element Voltage (Linear Law)		200V
Contact Resistance Variation		1% or 3Ω
End Resistance (Typical)		0.1% or 3Ω
Dielectric Strength (RMS)		1000V
Insulation Resistance		10 ⁶ MΩ

MECHANICAL SPECIFICATIONS

Mechanical Travel	270° ± 10°
Operating Torque (max. Ncm)	1.5
End Stop Torque (max. Ncm)	3.5
Unit Weight (max. g)	0.15

ENVIRONMENTAL SPECIFICATIONS

Temperature Range	- 55°C to + 125°C
Climatic Category	55 / 125 / 56
Sealing	sealed container solder immersion IP67

POWER RATING CHART

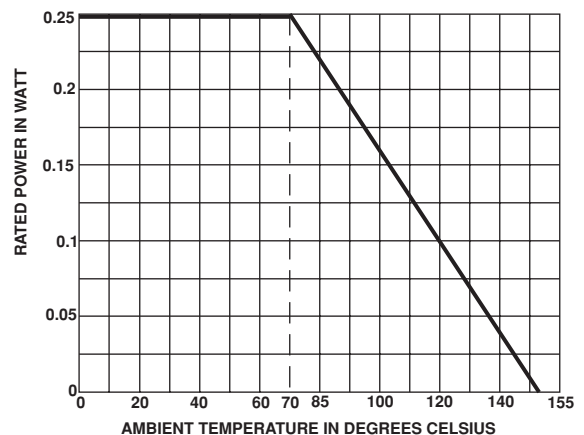

PERFORMANCE			
TESTS	CONDITIONS	TYPICAL VALUES AND DRIFTS	
		$\frac{\Delta RT}{RT}$ (%)	$\frac{\Delta R_{1-2}}{R_{1-2}}$ (%)
Load Life	1000 hours at rated power 90/30' - ambient temperature + 85°C	± 2%	± 3 % Contact resistance variation: $\Delta R < 1\% R_n$
Moisture Resistance	MIL STD 202 Method 106 10 cycles of 24 hours constituted with damp heat - cold - vibrations	± 2 %	± 3 % Dielectric strength: 1000 V RMS Insulation resistance: > 10 ⁴ MΩ
Long Term Damp Heat	Temperature 40°C - RH 93 % 56 days	± 2 %	± 3 % Dielectric strength: 1000 V RMS Insulation resistance: > 10 ⁴ MΩ
Thermal Shock	55°C to + 125°C - 5 cycles	± 1 %	$\frac{\Delta V_{1-2}}{V_{1-3}} \leq \pm 2\%$
Rotational Life (Electrical and Mechanical)	100 cycles - rated power	± 3 %	
Shock	MIL STD 202 Method 213/1 100 g - 6 ms 3 successive shocks in 3 directions	± 1 %	$\frac{\Delta V_{1-2}}{V_{1-3}} \leq \pm 1\%$
Vibration	MIL STD 202 Method 204/D 20 g - 12 hours	± 1 %	$\frac{\Delta V_{1-2}}{V_{1-3}} \leq \pm 1\%$

STANDARD RESISTANCE ELEMENT DATA				
STANDARD RESISTANCE VALUES	LINEAR LAW			T.C. -55°C +125°C ppm/°C
	MAX. POWER AT 85°C	MAX. WORKING VOLTAGE	MAX. CUR. THROUGH ELEMENT	
Ω	W	V	mA	
10	0.20	1.41	141	0 + 200
20	↓	2	100	
50		3.16	63	
100		4.47	45	
200		6.32	32	
500		10	20	
1k		14.1	14	
2k		20	10	
5k		31.6	6.3	
10k		44.7	4.5	
20k		63.2	3.2	± 100
50k	0.2	100	2	
100k	0.2	141	1.4	
200k	0.2	200	1	
500k	0.08	200	0.4	
1M	0.04	200	0.2	

MARKING

VISHAY trademark, ohmic value, manufacturing date.

The ohmic value is indicated by a 3 figure code, the first two are significant figures, the third one is the multiplier.

Example: 100 = 10Ω
 101 = 100Ω
 102 = 1000Ω
 503 = 50000Ω

SOLDERING RECOMMENDATIONS

Vapor phase: 215°C/20 to 40 seconds.

Reflow: 230°C/20 seconds.

Do not exceed peak 260°C or with an IRON 40W: 3 seconds at 350°C.

Soldering is possible by wave, reflow and vapor phase.

PACKAGING

On tape and reel of 500 pieces, code TR and 2000 pieces, code TR1

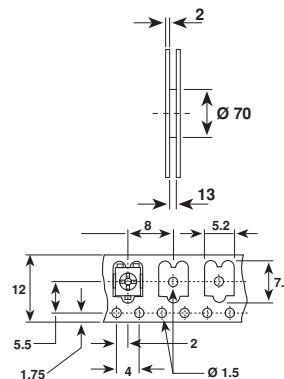
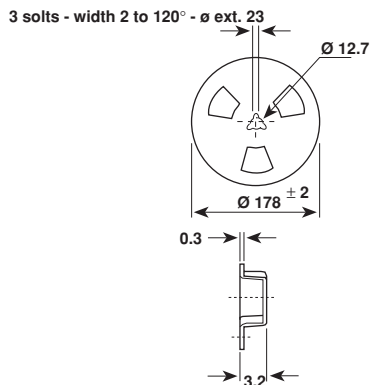

Cover tape panel strength specifications EIA 481 A and CEI 60286-3.

ORDERING INFORMATION

TS53 SERIES	YL STYLE	500KΩ OHMIC VALUE	± 20% TOLERANCE	TR500 PACKAGING
----------------	-------------	----------------------	--------------------	--------------------

TR: Tape and reel 500 pcs.
 on request: TR1: Tape and reel 2000 pcs.

SAP PART NUMBERING GUIDELINES

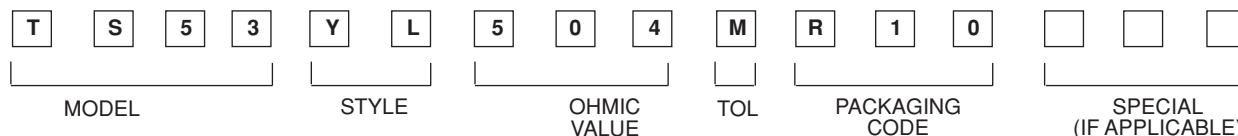

See the end of this data book for conversion tables