

APPLICATIONS

- Rectification.
- Freewheel Diode.
- DC Motor Control.
- Power Supplies.
- Welding.
- Battery Chargers.

KEY PARAMETERS

V_{RRM}	1800V
$I_{F(AV)}$	2320A
I_{FSM}	41250A

FEATURES

- Double Side Cooling.
- High Surge Capability.

VOLTAGE RATINGS

Type Number	Repetitive Peak Reverse Voltage V_{RRM} V	Conditions
TR2002SF18	1800	$V_{RSM} = V_{RRM} + 100V$
TR2002SF17	1700	
TR2002SF16	1600	
TR2002SF15	1500	
TR2002SF14	1400	
TR2002SF13	1300	

Lower voltage grades available.

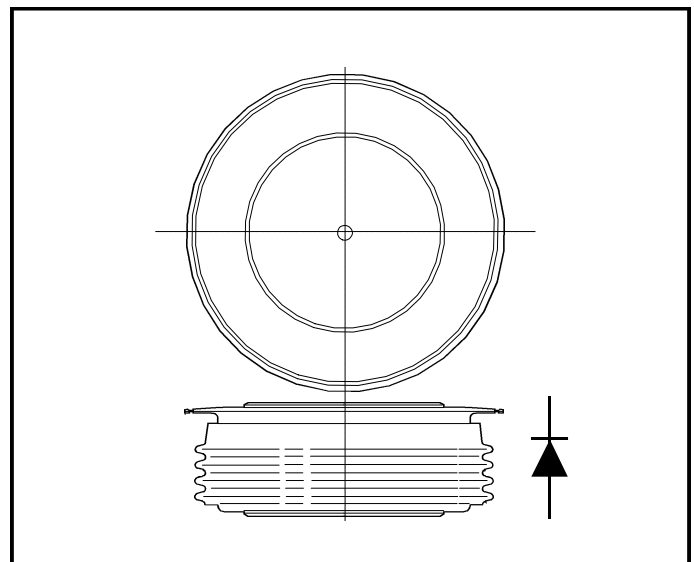

Outline type code: F
See Package Details for further information.

CURRENT RATINGS

Symbol	Parameter	Conditions	Max.	Units
Double Side Cooled				
$I_{F(AV)}$	Mean forward current	Half wave resistive load, $T_{case} = 100^{\circ}C$	2320	A
$I_{F(RMS)}$	RMS value	$T_{case} = 100^{\circ}C$	3644	A
I_F	Continuous (direct) forward current	$T_{case} = 100^{\circ}C$	3300	A
Single Side Cooled (Anode side)				
$I_{F(AV)}$	Mean forward current	Half wave resistive load, $T_{case} = 100^{\circ}C$	1345	A
$I_{F(RMS)}$	RMS value	$T_{case} = 100^{\circ}C$	2110	A
I_F	Continuous (direct) forward current	$T_{case} = 100^{\circ}C$	1630	A

TR2002SF

SURGE RATINGS

Symbol	Parameter	Conditions	Max.	Units
I_{FSM}	Surge (non-repetitive) forward current	10ms half sine; $T_{case} = 175^{\circ}C$	33.0	kA
I^2t	I^2t for fusing	$V_R = 50\% V_{RRM}$ - 1/4 sine	5.44×10^6	A ² s
I_{FSM}	Surge (non-repetitive) forward current	10ms half sine; $T_{case} = 175^{\circ}C$	41.25	kA
I^2t	I^2t for fusing	$V_R = 0$	8.5×10^6	A ² s

THERMAL AND MECHANICAL DATA

Symbol	Parameter	Conditions	Min.	Max.	Units	
$R_{th(j-c)}$	Thermal resistance - junction to case	Double side cooled	dc	-	0.022	$^{\circ}C/W$
		Single side cooled	Anode dc	-	0.038	$^{\circ}C/W$
			Cathode dc	-	0.052	$^{\circ}C/W$
$R_{th(c-h)}$	Thermal resistance - case to heatsink	Clamping force 19.5kN with mounting compound	Double side	-	0.004	$^{\circ}C/W$
			Single side	-	0.008	$^{\circ}C/W$
T_{vj}	Virtual junction temperature	Forward (conducting)		-	185	$^{\circ}C$
		Reverse (blocking)		-	175	$^{\circ}C$
T_{stg}	Storage temperature range		-55	200	$^{\circ}C$	
-	Clamping force		18.0	22.0	kN	

CHARACTERISTICS

Symbol	Parameter	Conditions	Min.	Max.	Units
V_{FM}	Forward voltage	At 3400A peak, $T_{case} = 25^{\circ}C$	-	1.18	V
I_{RRM}	Peak reverse current	At V_{RRM} , $T_{case} = 175^{\circ}C$	-	50	mA
Q_S	Total stored charge	$I_F = 2000A$, $dI_{RR}/dt = 3A/\mu s$	-	1500	μC
I_{RR}	Peak recovery current	$T_{case} = 175C$, $V_R = 100V$	-	90	A
V_{TO}	Threshold voltage	At $T_{vj} = 175C$	-	0.74	V
r_T	Slope resistance	At $T_{vj} = 175C$	-	0.088	m Ω

CURVES

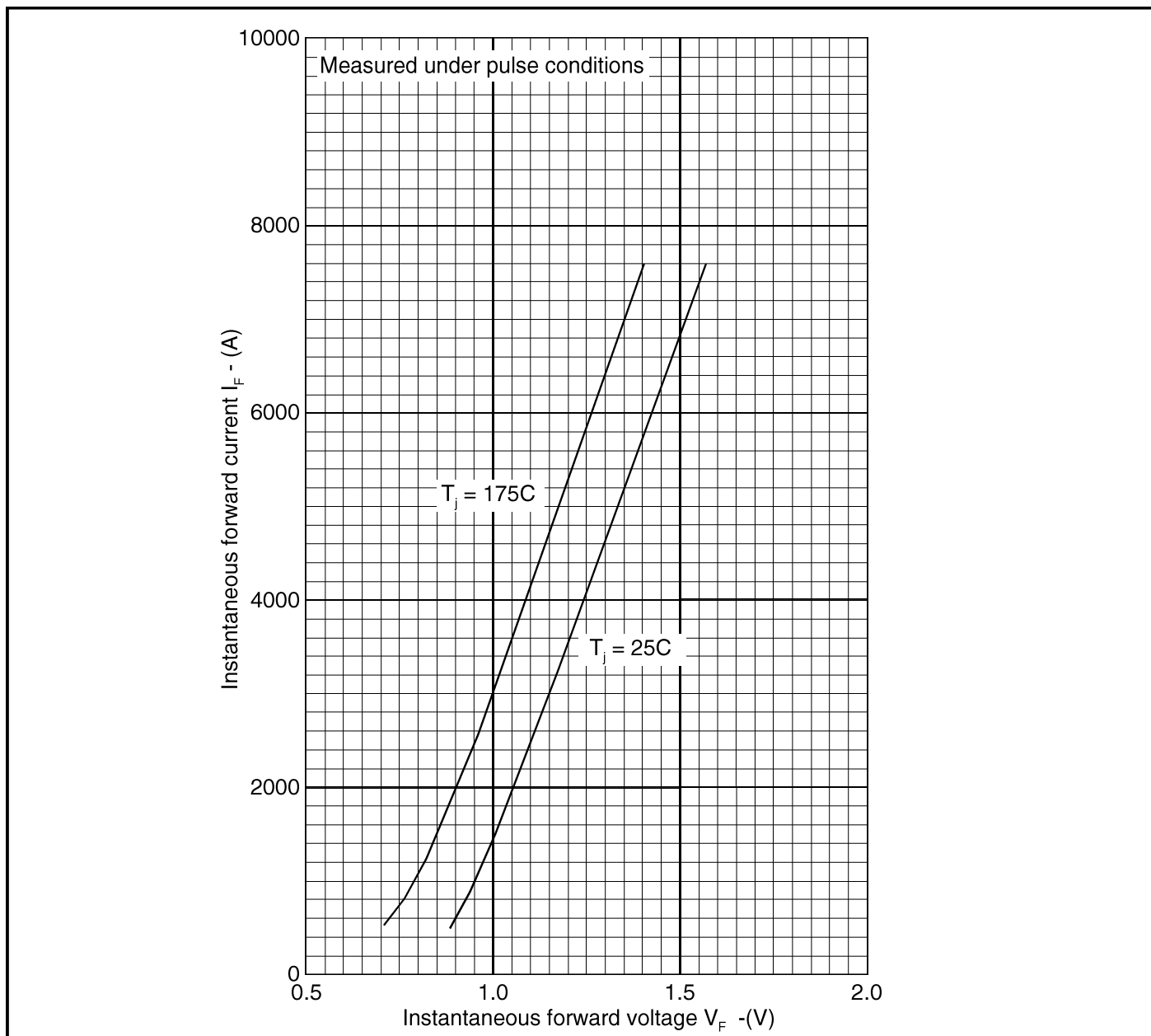

Fig.1 Maximum (limit) forward characteristics

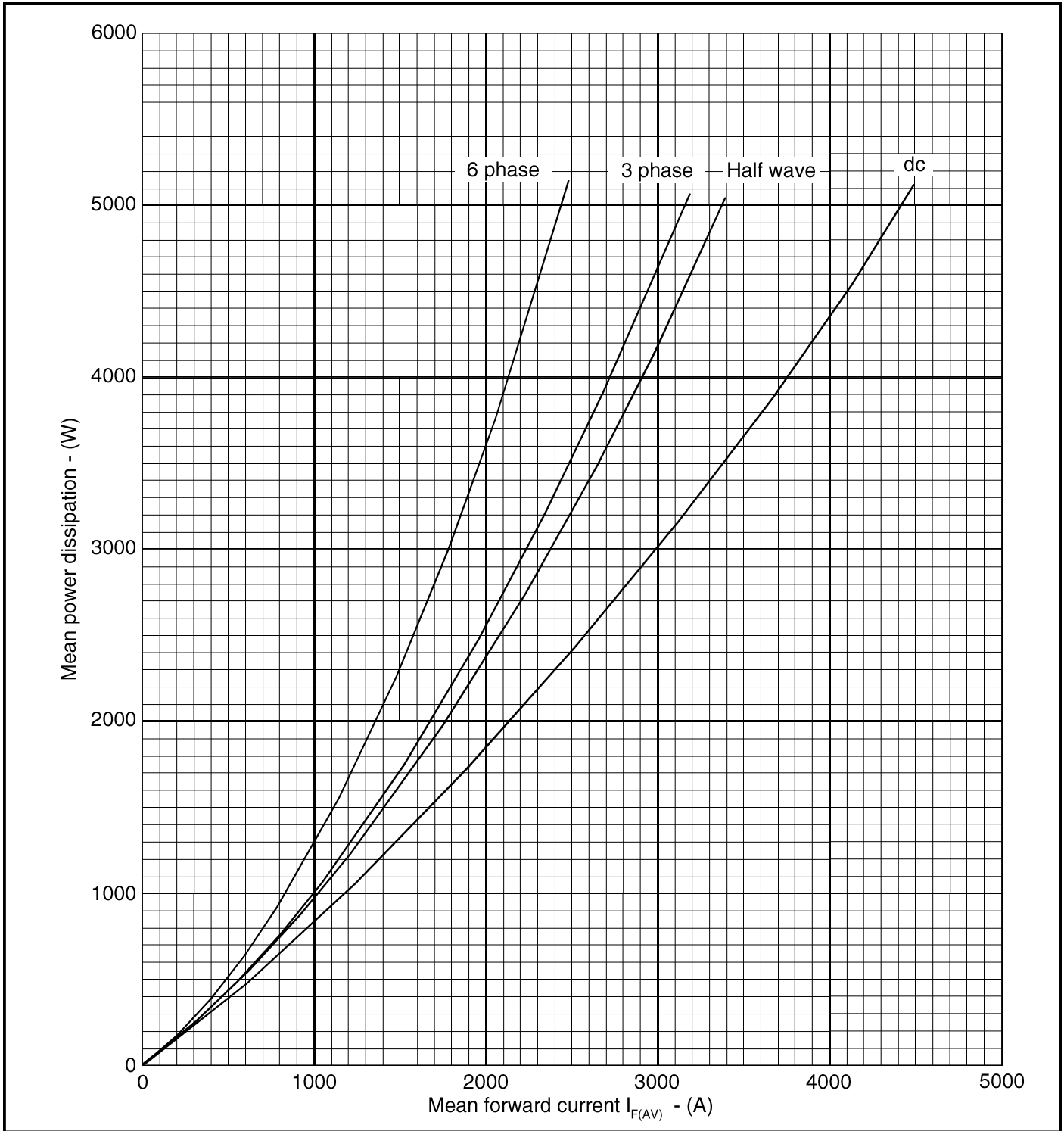

Fig.2 Dissipation curves

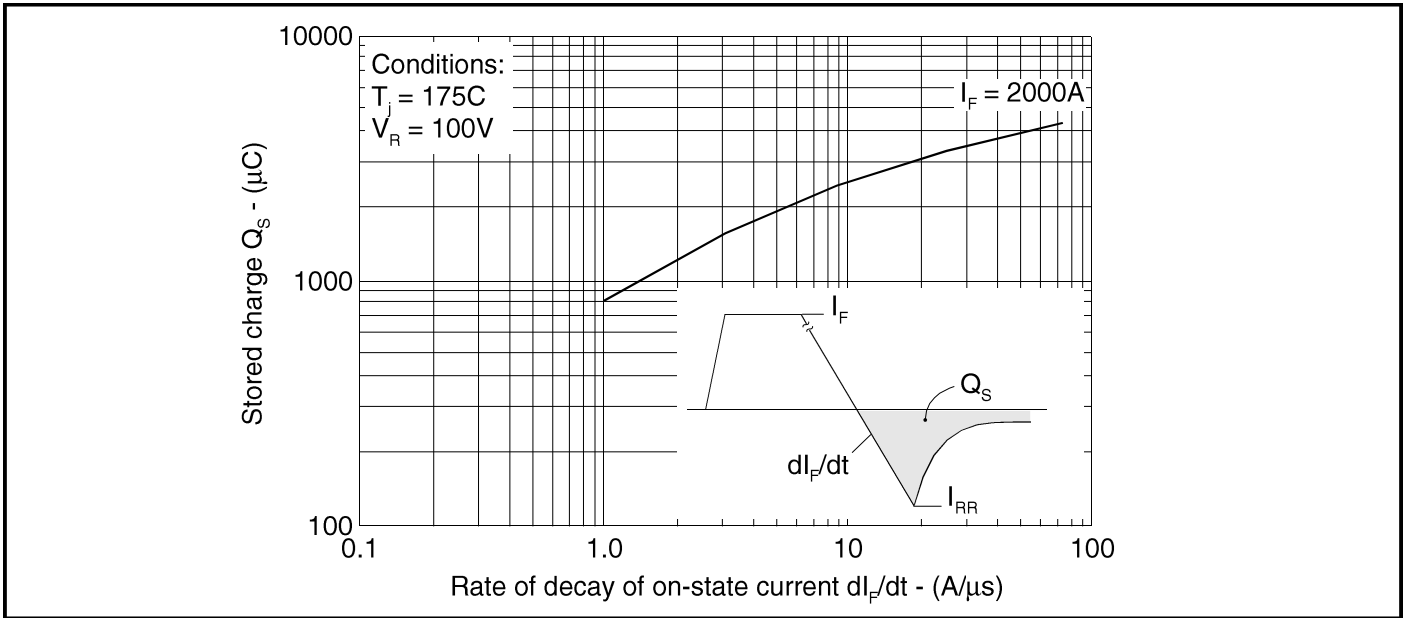

Fig.3 Maximum total stored charge

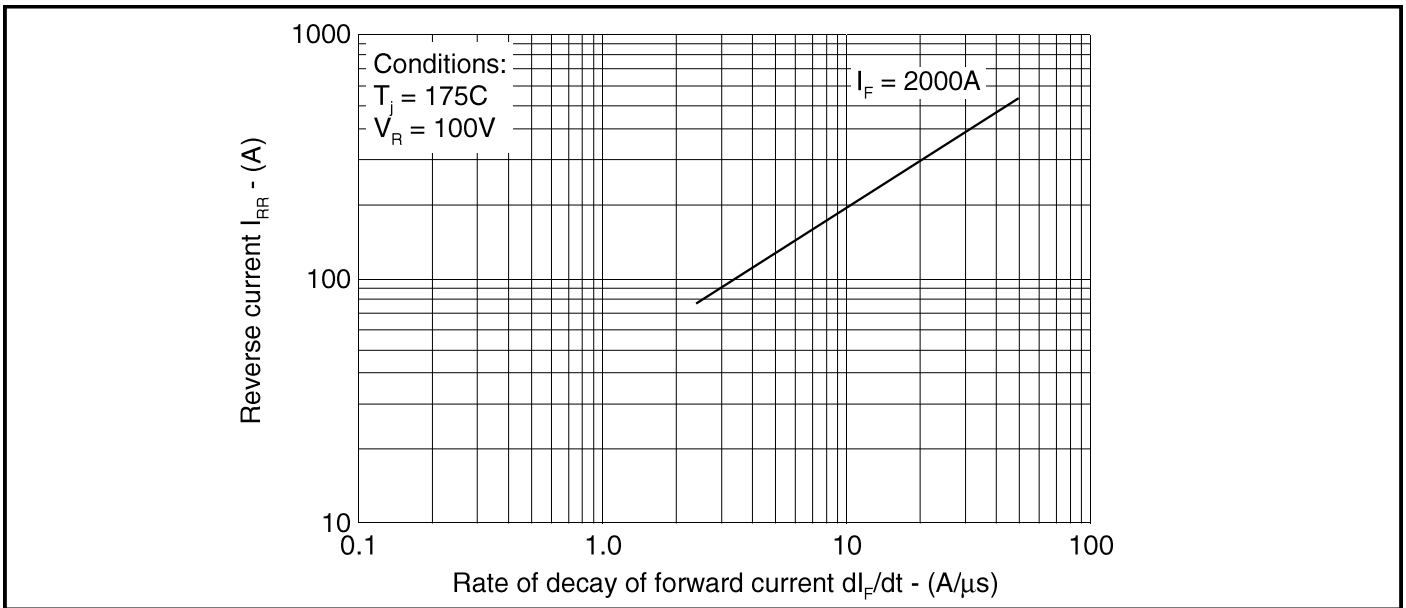

Fig. 4 Maximum reverse recovery current

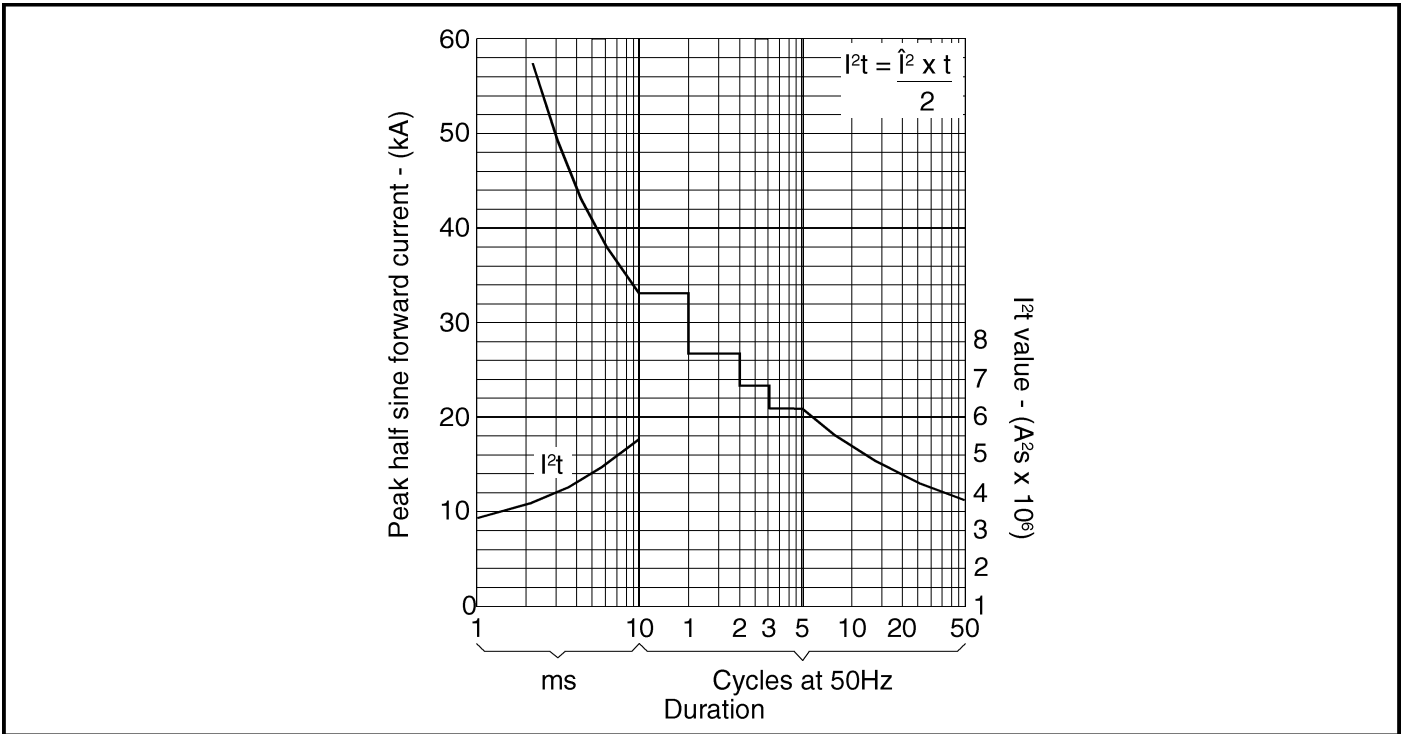

Fig. 5 Surge (non-repetitive) forward current vs time (with 50% V_{RRM} , $T_{case} = 175C$)

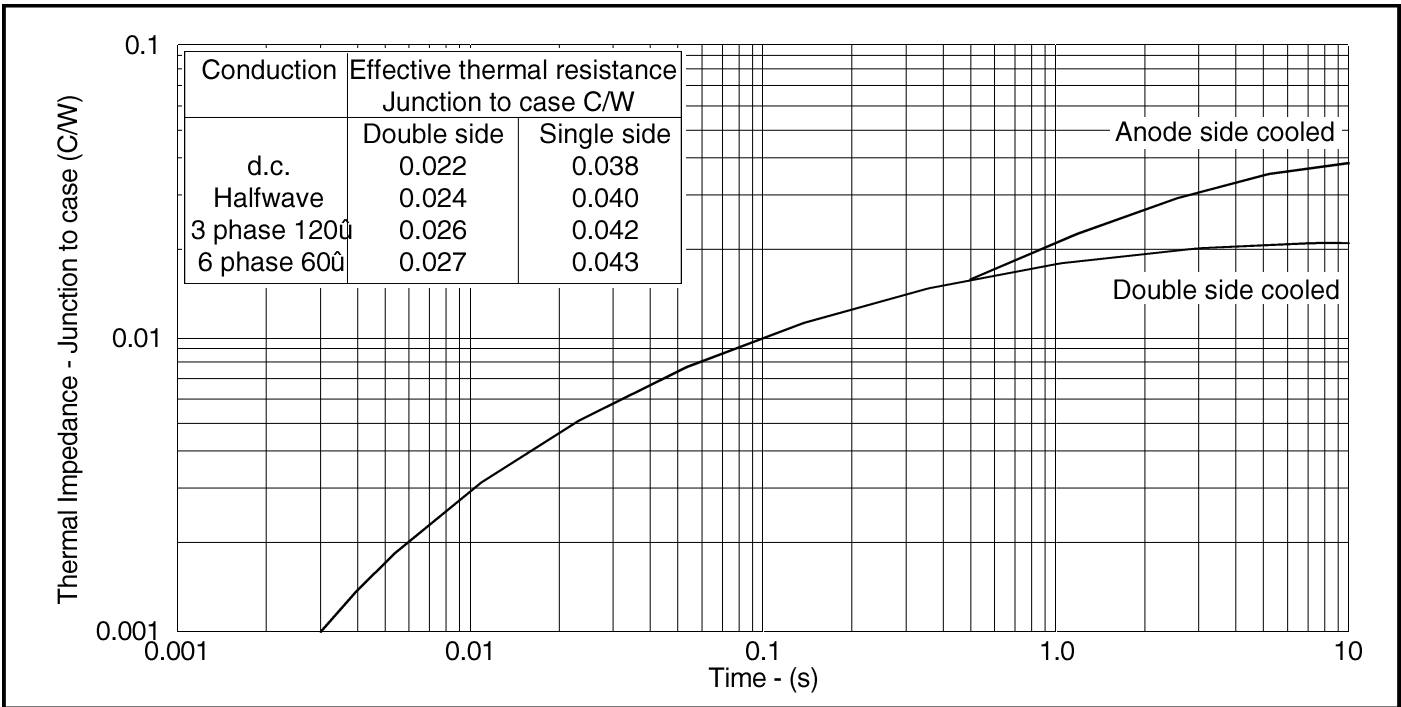

Fig. 6 Transient thermal impedance - junction to case - (C/W)

PACKAGE DETAILS

For further package information, please contact your local Customer Service Centre. All dimensions in mm, unless stated otherwise.
DO NOT SCALE.

