

**Major Ratings and Characteristics**



Characteristics	Values	Units
$I_{F(AV)}$ Rectangular waveform	2 x 15	A
$V_{RRM}$	30	V
$V_F$ @ 15 Apk, $T_J = 125^\circ\text{C}$ (Per Leg)	0.37	V
$T_J$ range	-55 to 150	$^\circ\text{C}$

**Description/ Features**

This center tap Schottky rectifier has been optimized for very low forward voltage drop, with moderate leakage. The proprietary barrier technology allows for reliable operation up to  $150^\circ\text{C}$  junction temperature. Typical applications are in switching power supplies, converters, free-wheeling diodes, and reverse battery protection.

- $150^\circ\text{C}$   $T_J$  operation
- Center tap configuration
- Very low forward voltage drop
- High purity, high temperature epoxy encapsulation for enhanced mechanical strength and moisture resistance
- High frequency operation
- Guard ring for enhanced ruggedness and long term reliability

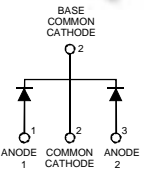
**Case Styles**

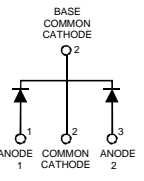
<p><b>STPS30L30CT</b></p>  <div style="text-align: center;">  <p>TO-220</p> </div>	<p><b>STPS30L30CG</b></p>  <div style="text-align: center;">  <p>D<sup>2</sup>PAK</p> </div>
--	--

## Voltage Ratings

Parameters	Values
$V_R$ Max. DC Reverse Voltage (V)	30
$V_{RWM}$ Max. Working Peak Reverse Voltage (V)	

## Absolute Maximum Ratings

Parameters	Values	Units	Conditions
$I_{F(AV)}$ Max. Average Forward Per Device Current Per Leg	30 15	A	50% duty cycle @ $T_C = 140^\circ\text{C}$ , rectangular wave form
$I_{FSM}$ Max. Peak One Cycle Non-Repetitive Surge Current	1450 220	A	5 $\mu\text{s}$ Sine or 3 $\mu\text{s}$ Rect. pulse 10ms Sine or 6ms Rect. pulse Following any rated load condition and with rated $V_{RWM}$ applied
$E_{AS}$ Non-Repetitive Avalanche Energy (Per Leg)	15	mJ	$T_J = 25^\circ\text{C}$ , $I_{AS} = 2$ Amps, $L = 7.5$ mH
$I_{AR}$ Repetitive Avalanche Current (Per Leg)	2	A	Current decaying linearly to zero in 1 $\mu\text{sec}$ Frequency limited by $T_J$ max. $V_A = 1.5 \times V_R$ typical

## Electrical Specifications

Parameters	Values	Units	Conditions
$V_{FM}$ Max. Forward Voltage Drop (Per Leg) (1)	0.46	V	@ 15A
	0.57	V	@ 30A
	0.37	V	@ 15A
	0.50	V	@ 30A
$I_{RM}$ Max. Reverse Leakage Current (Per Leg)	1.50	mA	$T_J = 25^\circ\text{C}$
	350	mA	$T_J = 125^\circ\text{C}$
$C_T$ Max. Junction Capacitance (Per Leg)	1500	pF	$V_R = 5V_{DC}$ (test signal range 100Khz to 1Mhz) $25^\circ\text{C}$
$L_S$ Typical Series Inductance (Per Leg)	8.0	nH	Measured lead to lead 5mm from package body
$dv/dt$ Max. Voltage Rate of Change (Rated $V_R$ )	10000	V/ $\mu\text{s}$	

(1) Pulse Width < 300 $\mu\text{s}$ , Duty Cycle <2%

## Thermal-Mechanical Specifications

Parameters	Values	Units	Conditions
$T_J$ Max. Junction Temperature Range	-55 to 150	$^\circ\text{C}$	
$T_{stg}$ Max. Storage Temperature Range	-55 to 150	$^\circ\text{C}$	
$R_{thJC}$ Max. Thermal Resistance Junction to Case (Per Leg)	1.5	$^\circ\text{C}/\text{W}$	DC operation
$R_{thJC}$ Max. Thermal Resistance Junction to Case (Per Package)	0.8	$^\circ\text{C}/\text{W}$	DC operation
wt Approximate Weight	2 (0.07)	g (oz.)	
T Mounting Torque	Min.	6 (5)	Kg-cm (lbf-in)
	Max.	12 (10)	

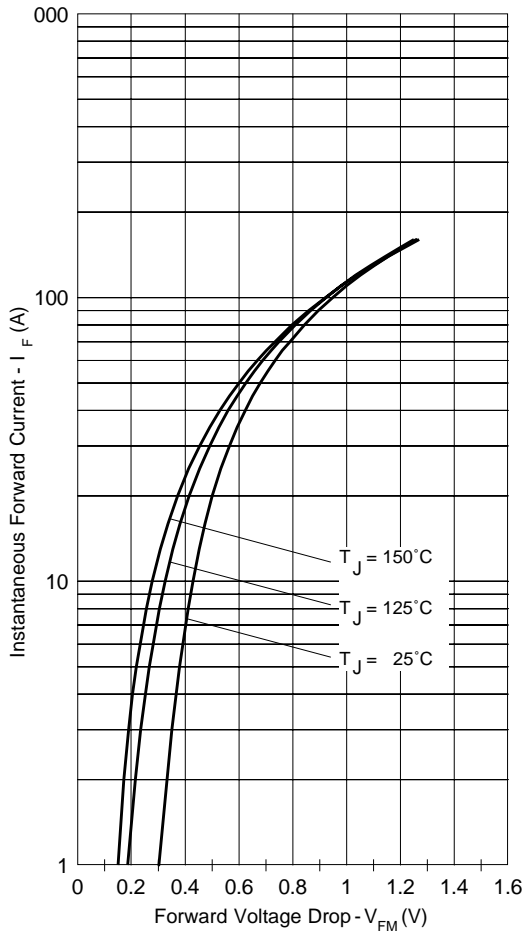

Fig. 1 - Maximum Forward Voltage Drop Characteristics

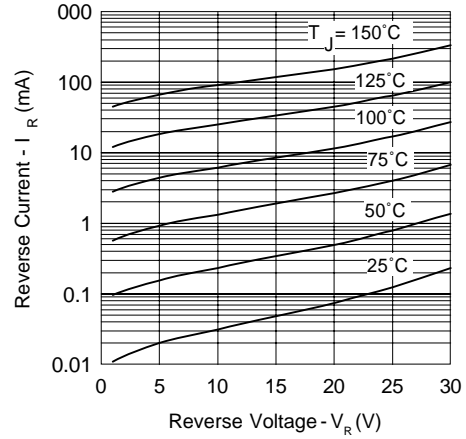

Fig. 2 - Typical Values of Reverse Current Vs. Reverse Voltage

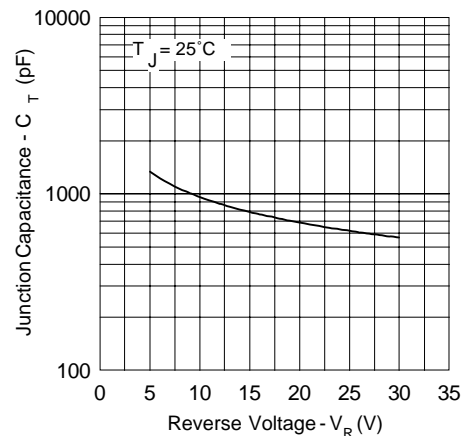

Fig. 3 - Typical Junction Capacitance Vs. Reverse Voltage

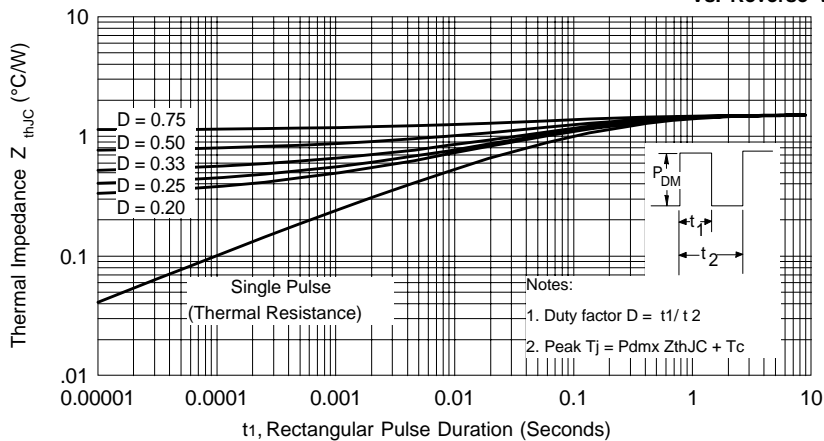
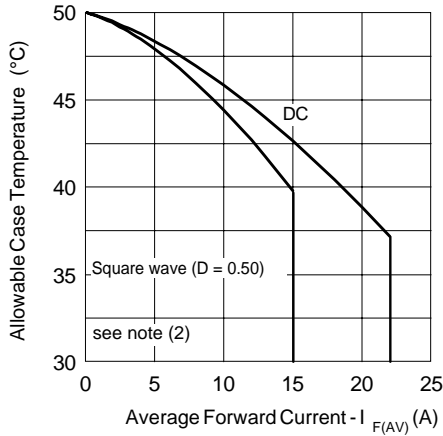
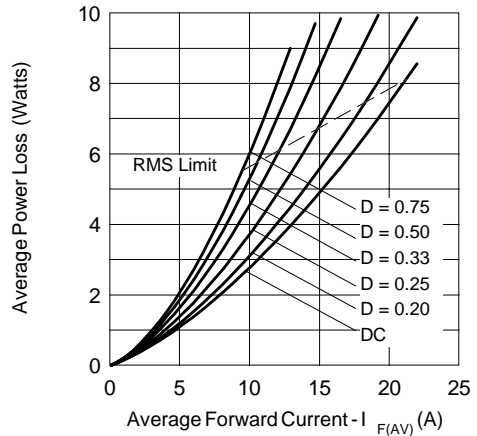

Fig. 4 - Max. Thermal Impedance  $Z_{thJC}$  Characteristics



**Fig. 5 - Max. Allowable Case Temperature Vs. Average Forward Current**



**Fig. 6 - Forward Power Loss Characteristics**

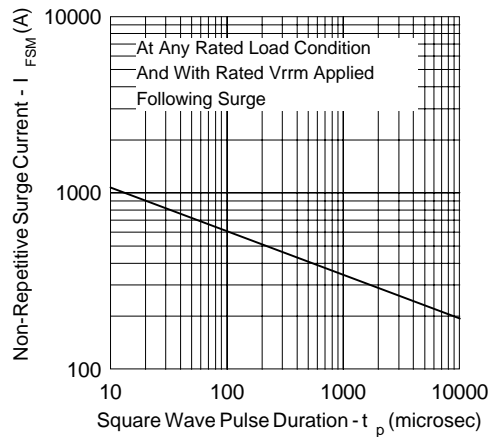
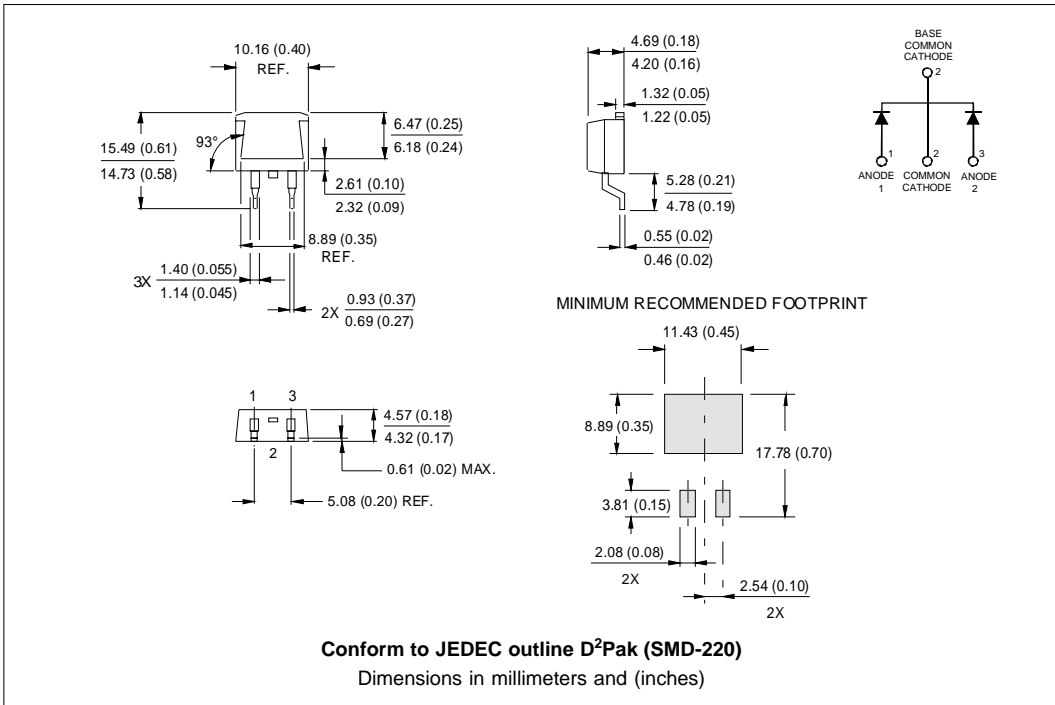
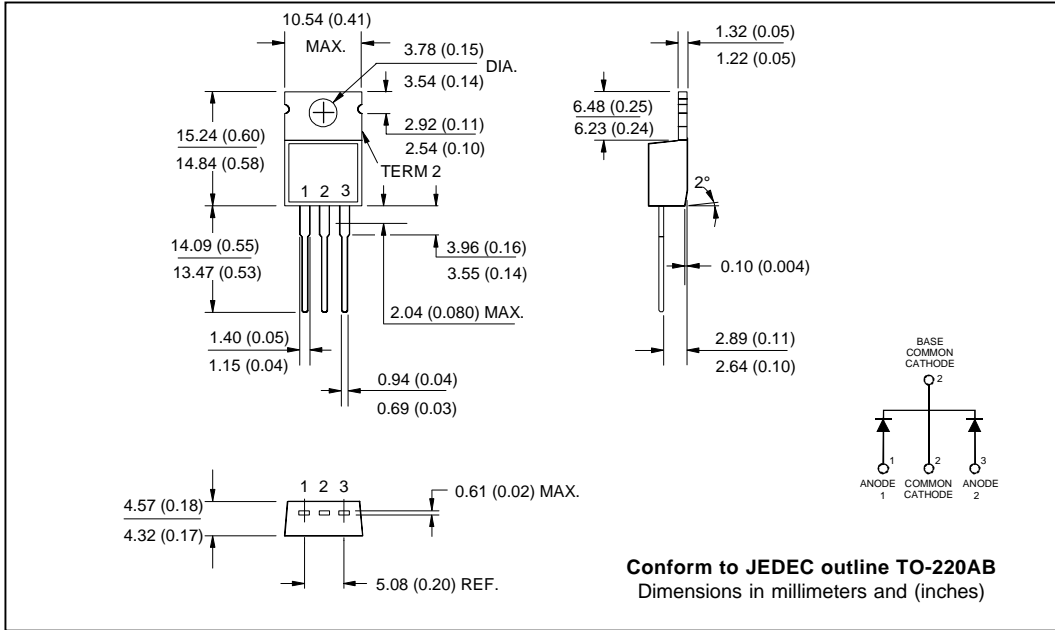

**Fig. 7 - Max. Non-Repetitive Surge Current (Per Leg)**

(2) Formula used:  $T_C = T_J - Pd \times R_{thJC}$ ;

$Pd = \text{Forward Power Loss} = I_{F(AV)} \times V_{FM} @ (I_{F(AV)}/D)$  (see Fig. 6)

Outline Table



Tape & Reel Information

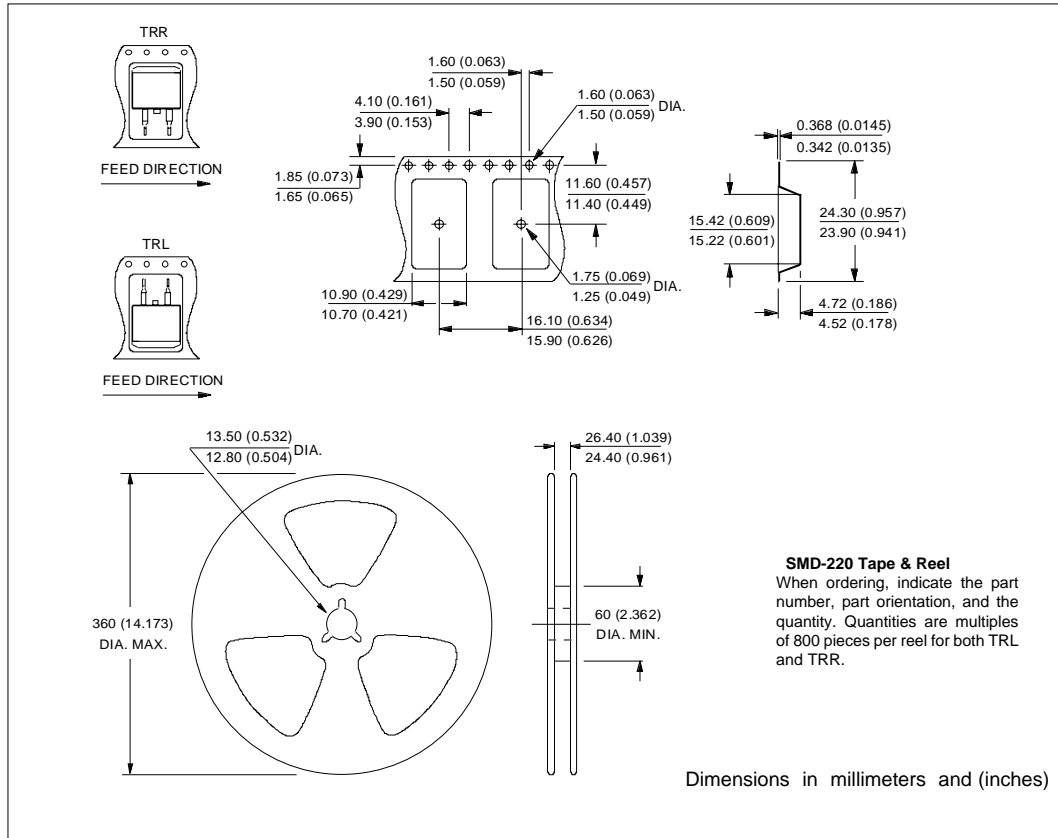

Marking Information

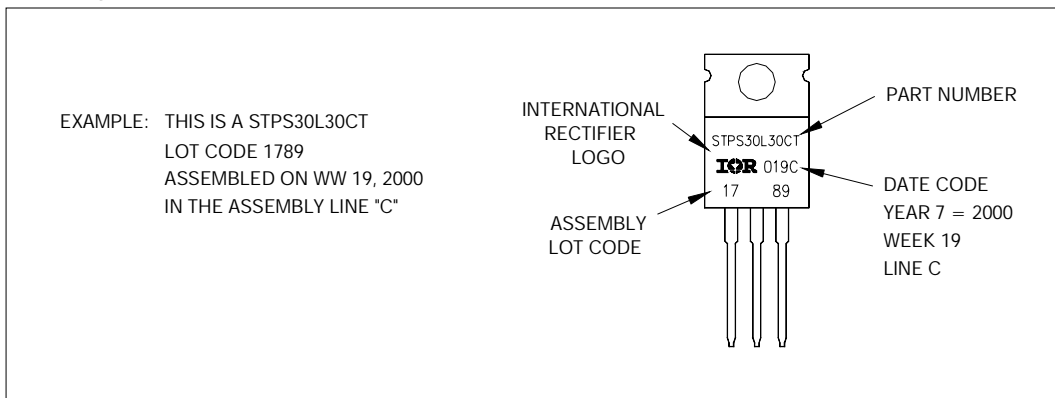

```

30L30CT
*****
    This model has been developed by
    Wizard SPICE MODEL GENERATOR (1999)
    (International Rectifier Corporation)
    contains Proprietary Information
*****

    SPICE Model Diode is composed by a
    simple diode plus paralld VCG2T
*****

.SUBCKT 30L30ct ANO CAT
D1 ANO 1 DMOD (0.08936)
*Define diode model
.MODEL DMOD D(IS=3.01789428908089E-04A,N=1.12506549677918,BV=35V,
+ IBV=0.40837541124234A,RS= 0.000285952,CJO=3.65460570356249E-08,
+ VJ=0.934944724736772,XTI=2, EG=0.674450307828855)
*****

*Implementation of VCG2T
VX 1 2 DC 0V
R1 2 CAT TRES 1E-6
.MODEL TRES RES(R=1,TC1=11.2856367229303)
GP1 ANO CAT VALUE={-ABS(I(VX))*(EXP((( -2.138249E-03/11.28564)*((V(2,CAT)*1E6)/(I(VX)+1E-6)-
1))+1)*9.434315E-02*ABS(V(ANO,CAT)))-1}}
*****

.ENDS 30L30ct

Thermal Model Subcircuit
.SUBCKT 30L30CT 5 1

CTHERM1  5  4  3.53E-1
CTHERM2  4  3  6.35E0
CTHERM3  3  2  5.15E+1
CTHERM4  2  1  4.08E+3

R THERM1  5  4  3.15E-1
R THERM2  4  3  6.15E-1
R THERM1  3  2  3.7E-1
R THERM1  2  1  1.98E-1

.ENDS 30L30CT
    
```

Data and specifications subject to change without notice.  
 This product has been designed and qualified for Industrial Level.  
 Qualification Standards can be found on IR's Web site.