

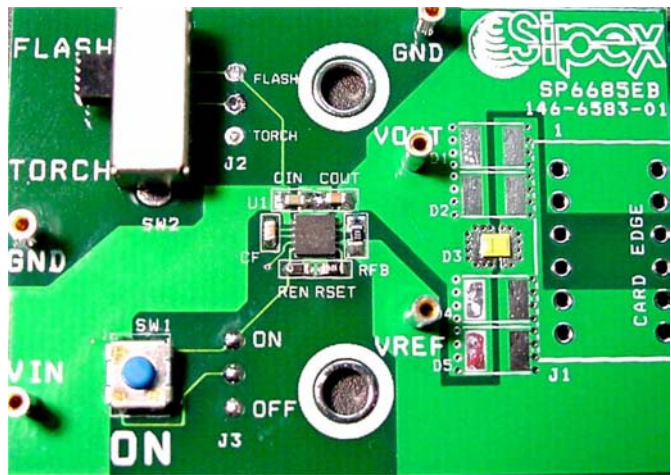

SP6685EB Evaluation Board Manual

- 2.7V to 4.2V Input Range
- Typical 200mA Torch or 700mA Flash Output Current
- High Efficiency in 1X mode, high V_{OUT} in 2X mode
- Small 3x3mm 10-Pin DFN Package
- 2.4MHz Switching Frequency Enables Small Components
- Integrated Design with Minimal Components.
- Use with 1 cell Lithium Ion Battery



DESCRIPTION AND BOARD SCHEMATIC

The **SP6685EB Evaluation Board** is a compact circuit including the SP6685 in 3x3mm DFN and 3 small 0603 capacitors which can provide a stable drive current for a 1W LED such as the Lumi-LEDs Luxeon I or PWF1 type light sources. The evaluation board is a completely assembled and tested surface mount board which provides easy probe access points to all SP6685 inputs and outputs so that the user can quickly connect and measure electrical characteristics and waveforms.

SP6685EB Schematic

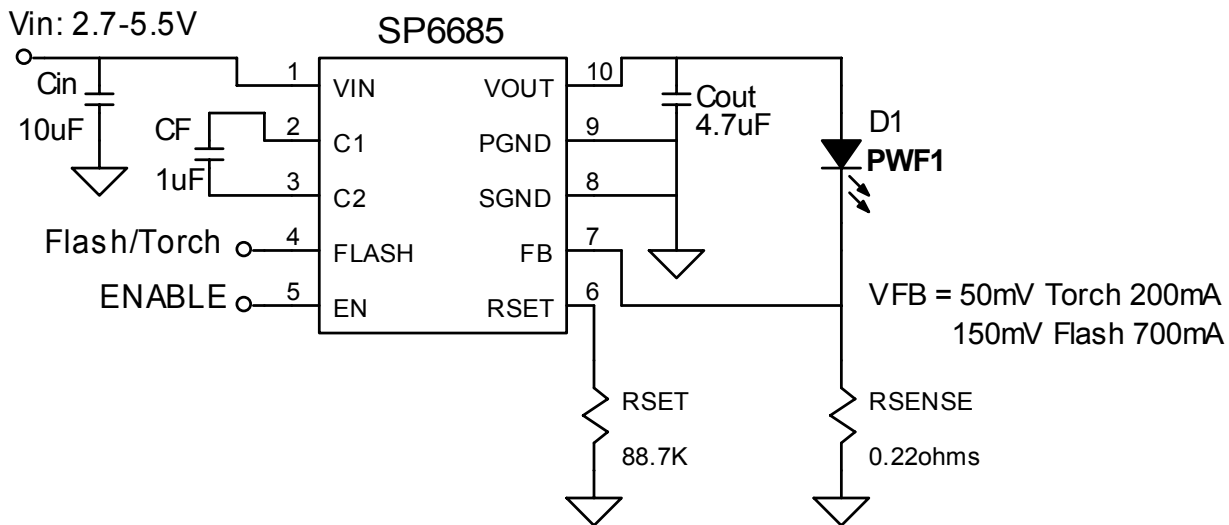

TO GET STARTED:

1. Connect VIN from VIN to GND (VIN range 2.7V to 4.2V).
2. Select mode between TORCH and FLASH by putting jumper into corresponding position.
3. Apply High to ON terminal to turn the LED on.

POWER SUPPLY DATA

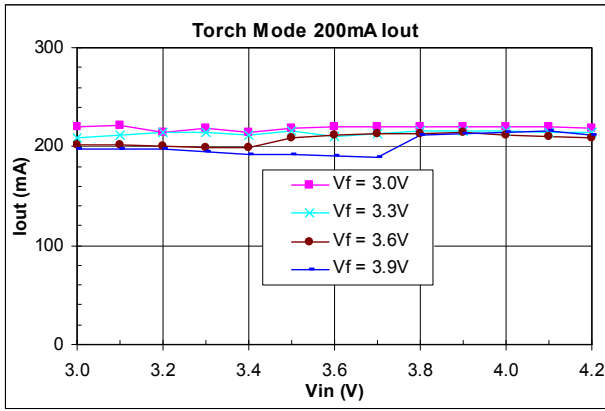

Figure 1. Torch Mode Output Current

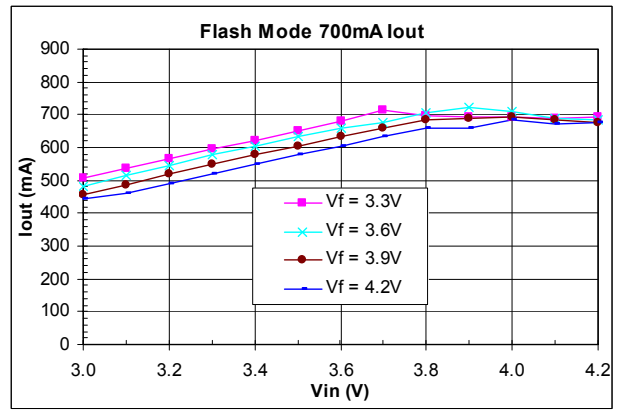

Figure 2. Flash Mode Output Current

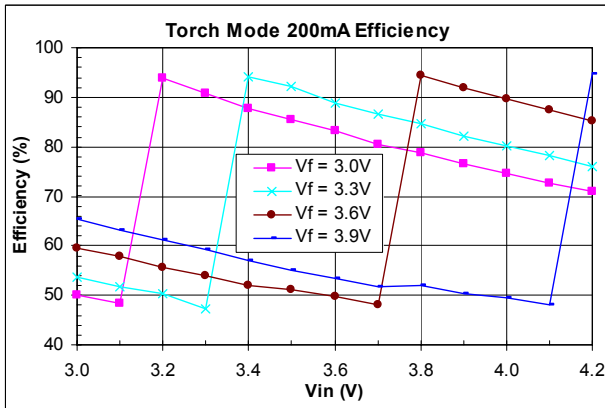

Figure 3. Torch Mode Efficiency

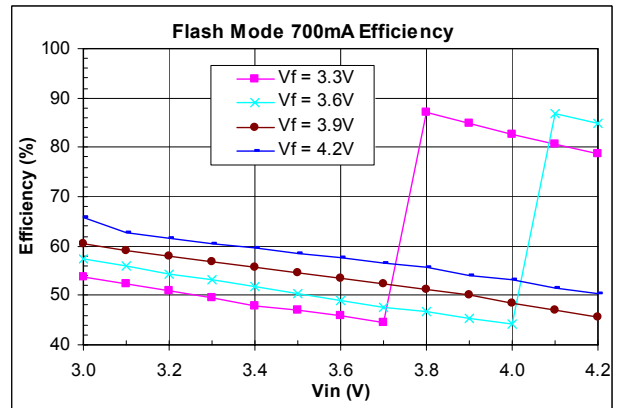

Figure 4. Flash Mode Efficiency

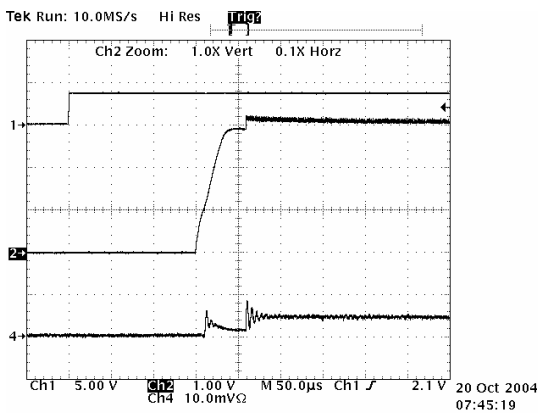

Figure 5. Startup 200mA Torch, Vin=3.6V, Vout=3.0V.

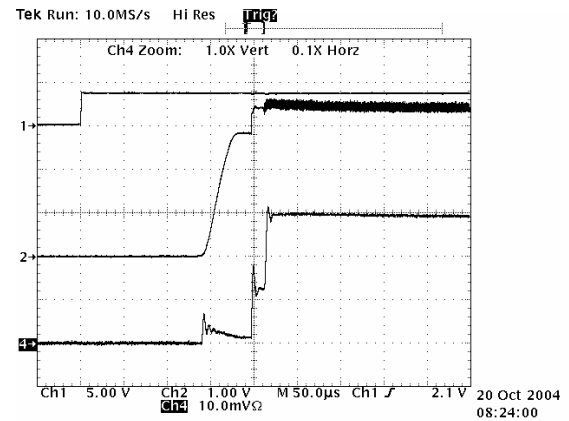

Figure 6. Startup 700mA Flash, Vin=3.6V, Vout=3.3V.

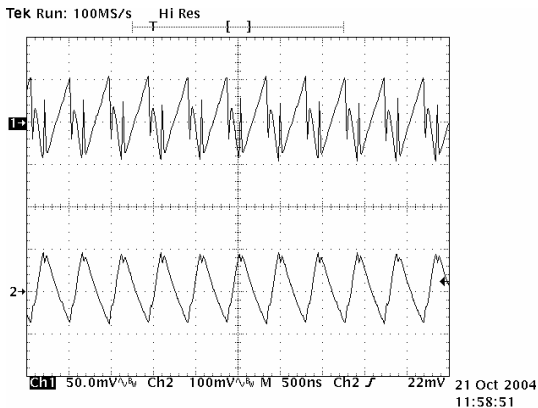

Figure 7. Ripple 200mA Torch, Vin=3.6V, Vout=3.15V.

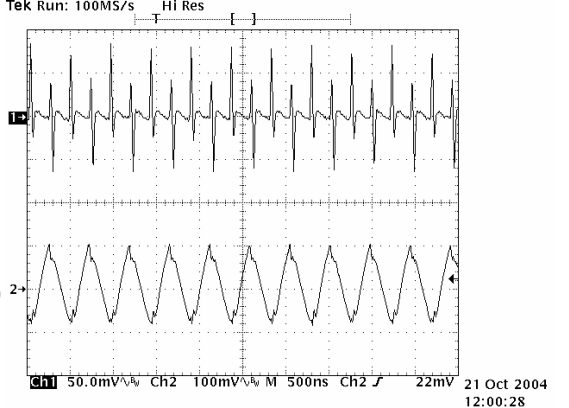

Figure 8. Ripple 700mA Flash, Vin=3.6V, Vout=3.35V.

EVALUATION BOARD LAYOUT

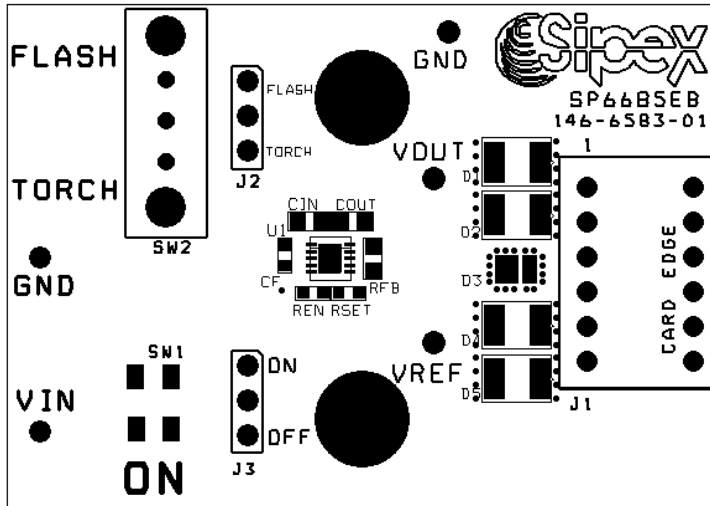

FIGURE 9: SP6685EB COMPONENT PLACEMENT

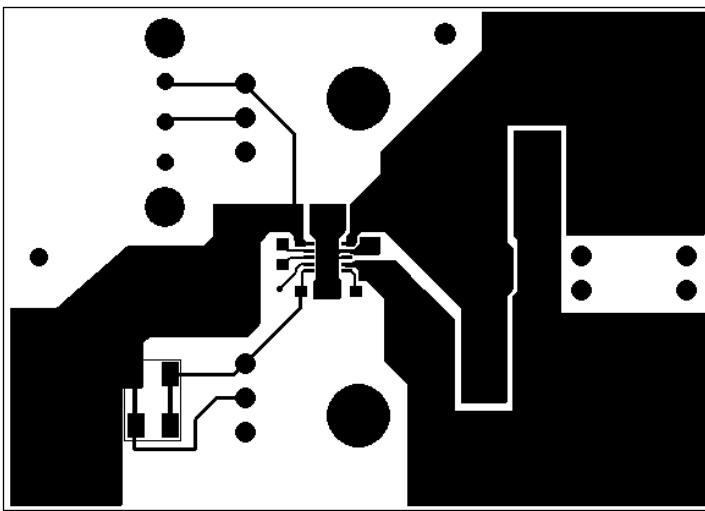

FIGURE 10: SP6685EB PC LAYOUT TOP SIDE

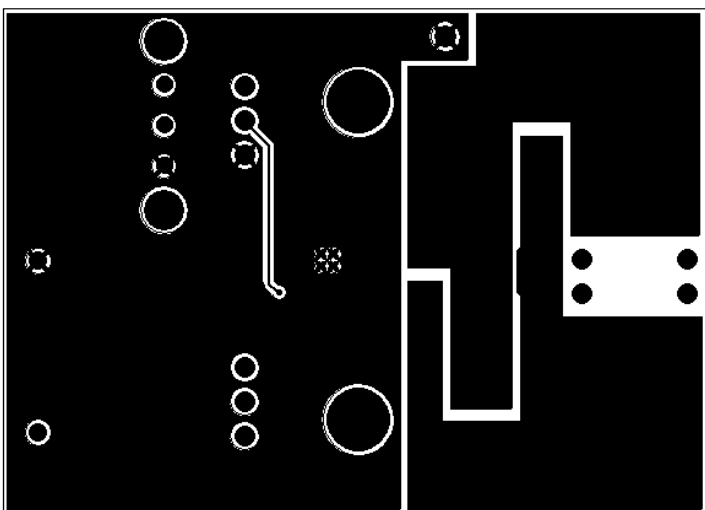

FIGURE 11: SP6685EB PC LAYOUT BOTTOM SIDE

TABLE1: SP6685EB LIST OF MATERIALS

Part Reference	Part Number	Value	Size	Manufacturers/ Website
U1	SP6685ER		3x3mm DFN - 10 pin	Sipex/www.sipex.cpm
CIN	GRM21BR60J106KE19L	10uF/6.3V	0805/X5R/1.35mm ht	Murata/www.murata.com
CF	GRM155R60J105KE19B	1uF/6.3V	0402/X5R/0.5mm ht	Murata/www.murata.com
COUT	GRM188R0J475KE19	4.7uF/6.3V	0603/X5R/0.9mm ht	Murata/www.murata.com
RSET	-	88.7K	0402	Rohm www.rohm.com Cyntec www.cyntec.com
RSENSE	-	0.22ohms	0603	Cyntec www.cyntec.com

ORDERING INFORMATION

Model	Temperature Range	Package Type
SP6685EB.....	-40°C to +85°C.....	SP6685EB Evaluation Board
SP6685ER.....	-40°C to +85°C.....	10-pin 3x3 DFN