

High Speed, Extremely Low Noise 150mA LDO Regulator

Features

- Low Dropout Voltage at $I_{OUT}=100mA$: 150mV Typical (Except 1.5V Version)
- Low Standby Current: 0.1 μA Typical
- Low Quiescent Current: 25 μA Typical
- High Ripple Rejection: 70dB Typical ($f=10kHz$)
- Maximum Output Current: More Than 150mA (300mA Limit)
- Extremely Low Noise: 30 μV_{rms} (10Hz to 100kHz)
- Excellent Line Regulation: 4mV Typical
- Excellent Load Regulation: 12mV Typical
- High Output Voltage Accuracy: $\pm 2\%$
- Excellent Line Transient Response and Load Transient Response
- Compatible with Low ESR Ceramic Capacitor (as Low as 1 μF)
- Available in Lead Free, RoHS Compliant Package: SOT-23-5

SOT-23-5 Package

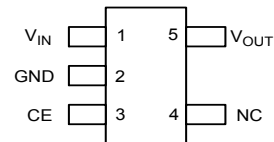

Applications

- Mobile Phones, Cordless Phones
- Wireless Communication Equipment
- Portable Games
- Cameras, Video Recorders
- Sub-board Power Supplies for Telecom Equipment
- Battery Powered Equipment

DESCRIPTION

The SP6260 series are positive voltage regulator ICs fabricated by CMOS process. Each of these ICs consists of a voltage reference, an error amplifier, a resistor network for setting output voltage, a current limit circuit for current protection and a chip enable circuit. The SP6260 series feature high ripple rejection, low dropout voltage, low noise, high output voltage accuracy, and low current consumption which make them ideal for use in various battery-powered devices. The SP6260 devices have 1.5V, 1.8V, 2.5V, 2.8V, 3.0V, 3.2V and 3.3V versions. The SP6260 is available in standard Lead Free, RoHS Compliant SOT-23-5 packaging.

TYPICAL APPLICATION CIRCUIT

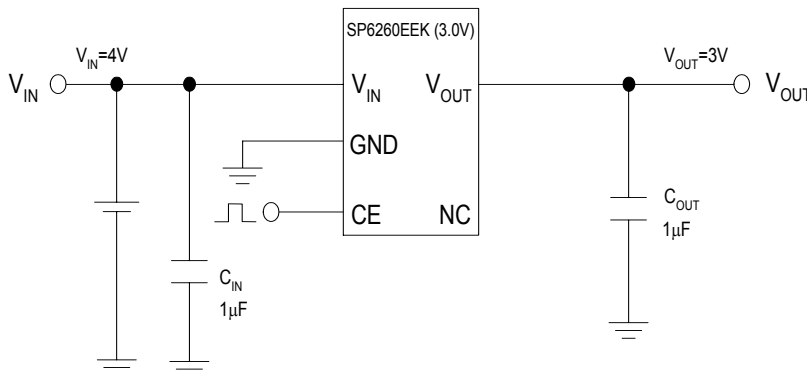

Pin Configuration



SOT-23-5

Package Pinout
(SOT-23-5)

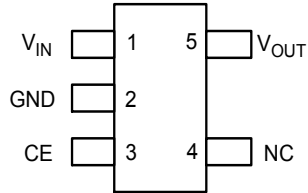

Package Perspective of SOT23-5

Pin Configuration of SP6260 (Top View)

Pin Description

Pin Number	Pin Name	Function
1	V_{IN}	Input voltage
2	GND	Ground
3	CE	Active high enable input pin. Logic high=enable, logic low=shutdown
4	NC	No connection
5	V_{OUT}	Regulated output voltage

Absolute Maximum Ratings (Note 1)

Parameter	Symbol	Value	Unit
Input Voltage	V_{IN}	6.5	V
Enable Input Voltage	V_{CE}	-0.3 to $V_{IN}+0.3$	V
Output Current	I_{OUT}	300	mA
Junction Temperature	T_J	150	°C
Storage Temperature Range	T_{STG}	-65 to 150	°C
Lead Temperature (Soldering, 10sec)	T_{LEAD}	260	°C
Thermal Resistance (Note 2) SOT-23-5	θ_{JA}	250	°C/W
ESD (Human Body Model)	ESD	2000	V
ESD (Machine Model)	ESD	200	V

Note 1: Stresses greater than those listed under "Absolute Maximum Ratings" may cause permanent damage to the device. These are stress ratings only, and functional operation of the device at these or any other conditions beyond those indicated under "Recommended Operating Conditions" is not implied. Exposure to "Absolute Maximum Ratings" for extended periods may affect device reliability.

Note 2: Absolute maximum ratings indicate limits beyond which damage to the component may occur. Electrical specifications do not apply when operating the device outside of its operating ratings. The maximum allowable power dissipation is a function of the maximum junction temperature, $T_{J(max)}$, the junction-to-ambient thermal resistance, θ_{JA} , and the ambient temperature, T_A . The maximum allowable power dissipation at any ambient temperature is calculated using: $P_{D(max)} = (T_{J(max)} - T_A) / \theta_{JA}$. Exceeding the maximum allowable power dissipation will result in excessive die temperature.

Recommended Operating Conditions

Parameter	Symbol	Min	Max	Unit
Input Voltage	V_{IN}	2	6	V
Operating Junction Temperature Range	T_J	-40	85	°C

Electrical Characteristics SP6260AEK (1.5V)

($V_{IN}=2.5V$, $T_J=25^{\circ}C$, $C_{IN}=1\mu F$, $C_{OUT}=1\mu F$, **Bold** typeface applies over $-40^{\circ}C \leq T_J \leq 85^{\circ}C$, unless otherwise specified.)

Parameter	Symbol	Conditions	Min	Typ	Max	Unit
Output Voltage	V_{OUT}	$V_{IN}=2.5V$ $1mA \leq I_{OUT} \leq 30mA$	1.47	1.5	1.53	V
Input Voltage	V_{IN}				6	V
Output Current	I_{OUT}	$V_{IN}-V_{OUT}=1V$	150			mA
Load Regulation	V_{RLOAD}	$V_{IN}=2.5V$ $1mA \leq I_{OUT} \leq 80mA$		12	40	mV
Line Regulation	V_{RLINE}	$2.3V \leq V_{IN} \leq 6V$ $I_{OUT}=30mA$		4	16	mV
Dropout Voltage	V_{DROP}	$I_{OUT}=10mA$		400	600	mV
		$I_{OUT}=100mA$		400	600	
		$I_{OUT}=150mA$		400	600	
Quiescent Current	I_Q	$V_{IN}=2.5V$, $I_{OUT}=0mA$		25	50	μA
Standby Current	I_{STD}	$V_{IN}=2.5V$ V_{CE} in OFF mode		0.1	1	μA
Power Supply Rejection Ratio	PSRR	Ripple 0.5Vp-p, $f=10kHz$ $V_{IN}=2.5V$		70		dB
Output Voltage Temperature Coefficient	$\Delta V_{OUT}/\Delta T$	$I_{OUT}=30mA$		± 150		$\mu V/^{\circ}C$
	$(\Delta V_{OUT}/V_{OUT})/\Delta T$			± 100		ppm/ $^{\circ}C$
Short Current Limit	I_{LIMIT}	$V_{OUT}=0V$		50		mA
RMS Output Noise	V_{NOISE}	$T_A=25^{\circ}C$ $10Hz \leq f \leq 100kHz$		30		μV_{rms}
CE "High" Voltage		CE input voltage "High"	1.5			V
CE "Low" Voltage		CE input voltage "Low"			0.25	V
CE Pull-down Resistance	R_{PD}		2.5	5	10	$M\Omega$

Electrical Characteristics (Continued)

SP6260BEK (1.8V)

($V_{IN}=2.8V$, $T_J=25^{\circ}C$, $C_{IN}=1\mu F$, $C_{OUT}=1\mu F$, **Bold** typeface applies over $-40^{\circ}C \leq T_J \leq 85^{\circ}C$, unless otherwise specified.)

Parameter	Symbol	Conditions	Min	Typ	Max	Unit
Output Voltage	V_{OUT}	$V_{IN}=2.8V$ $1mA \leq I_{OUT} \leq 30mA$	1.764	1.8	1.836	V
Input Voltage	V_{IN}				6	V
Output Current	I_{OUT}	$V_{IN}-V_{OUT}=1V$	150			mA
Load Regulation	V_{RLOAD}	$V_{IN}=2.8V$ $1mA \leq I_{OUT} \leq 80mA$		12	40	mV
Line Regulation	V_{RLINE}	$2.3V \leq V_{IN} \leq 6V$ $I_{OUT}=30mA$		4	16	mV
Dropout Voltage	V_{DROP}	$I_{OUT}=10mA$		20	40	mV
		$I_{OUT}=100mA$		150	300	
		$I_{OUT}=150mA$		200	400	
Quiescent Current	I_Q	$V_{IN}=2.8V$, $I_{OUT}=0mA$		25	50	μA
Standby Current	I_{STD}	$V_{IN}=2.8V$ V_{CE} in OFF mode		0.1	1	μA
Power Supply Rejection Ratio	PSRR	Ripple 0.5Vp-p, $f=10kHz$ $V_{IN}=2.8V$		70		dB
Output Voltage Temperature Coefficient	$\frac{\Delta V_{OUT}}{\Delta T}$	$I_{OUT}=30mA$		± 180		$\mu V/^{\circ}C$
	$(\Delta V_{OUT}/V_{OUT})/\Delta T$			± 100		ppm/ $^{\circ}C$
Short Current Limit	I_{LIMIT}	$V_{OUT}=0V$		50		mA
RMS Output Noise	V_{NOISE}	$T_A=25^{\circ}C$ $10Hz \leq f \leq 100kHz$		30		μV_{rms}
CE "High" Voltage		CE input voltage "High"	1.5			V
CE "Low" Voltage		CE input voltage "Low"			0.25	V
CE Pull-down Resistance	R_{PD}		2.5	5	10	M Ω

Electrical Characteristics (Continued)

SP6260CEK (2.5V)

($V_{IN}=3.5V$, $T_J=25^{\circ}C$, $C_{IN}=1\mu F$, $C_{OUT}=1\mu F$, **Bold** typeface applies over $-40^{\circ}C \leq T_J \leq 85^{\circ}C$, unless otherwise specified.)

Parameter	Symbol	Conditions	Min	Typ	Max	Unit
Output Voltage	V_{OUT}	$V_{IN}=3.5V$ $1mA \leq I_{OUT} \leq 30mA$	2.45	2.5	2.55	V
Input Voltage	V_{IN}				6	V
Output Current	I_{OUT}	$V_{IN}-V_{OUT}=1V$	150			mA
Load Regulation	V_{RLOAD}	$V_{IN}=3.5V$ $1mA \leq I_{OUT} \leq 80mA$		12	40	mV
Line Regulation	V_{RLINE}	$3V \leq V_{IN} \leq 6V$ $I_{OUT}=30mA$		4	16	mV
Dropout Voltage	V_{DROP}	$I_{OUT}=10mA$		20	40	mV
		$I_{OUT}=100mA$		150	300	
		$I_{OUT}=150mA$		200	400	
Quiescent Current	I_Q	$V_{IN}=3.5V$, $I_{OUT}=0mA$		25	50	μA
Standby Current	I_{STD}	$V_{IN}=3.5V$ V_{CE} in OFF mode		0.1	1	μA
Power Supply Rejection Ratio	PSRR	Ripple 0.5Vp-p, $f=10kHz$ $V_{IN}=3.5V$		70		dB
Output Voltage Temperature Coefficient	$\Delta V_{OUT}/\Delta T$	$I_{OUT}=30mA$		± 250		$\mu V/^{\circ}C$
	$(\Delta V_{OUT}/V_{OUT})/\Delta T$			± 100		ppm/ $^{\circ}C$
Short Current Limit	I_{LIMIT}	$V_{OUT}=0V$		50		mA
RMS Output Noise	V_{NOISE}	$T_A=25^{\circ}C$ $10Hz \leq f \leq 100kHz$		30		μV_{rms}
CE "High" Voltage		CE input voltage "High"	1.5			V
CE "Low" Voltage		CE input voltage "Low"			0.25	V
CE Pull-down Resistance	R_{PD}		2.5	5	10	$M\Omega$

Electrical Characteristics (Continued)

SP6260DEK (2.8V)

($V_{IN}=3.8V$, $T_J=25^{\circ}C$, $C_{IN}=1\mu F$, $C_{OUT}=1\mu F$, **Bold** typeface applies over $-40^{\circ}C \leq T_J \leq 85^{\circ}C$, unless otherwise specified.)

Parameter	Symbol	Conditions	Min	Typ	Max	Unit
Output Voltage	V_{OUT}	$V_{IN}=3.8V$ $1mA \leq I_{OUT} \leq 30mA$	2.744	2.8	2.856	V
Input Voltage	V_{IN}				6	V
Output Current	I_{OUT}	$V_{IN}-V_{OUT}=1V$	150			mA
Load Regulation	V_{RLOAD}	$V_{IN}=3.8V$ $1mA \leq I_{OUT} \leq 80mA$		12	40	mV
Line Regulation	V_{RLINE}	$3.3V \leq V_{IN} \leq 6V$ $I_{OUT}=30mA$		4	16	mV
Dropout Voltage	V_{DROP}	$I_{OUT}=10mA$		20	40	mV
		$I_{OUT}=100mA$		150	300	
		$I_{OUT}=150mA$		200	400	
Quiescent Current	I_Q	$V_{IN}=3.8V$, $I_{OUT}=0mA$		25	50	μA
Standby Current	I_{STD}	$V_{IN}=3.8V$ V_{CE} in OFF mode		0.1	1	μA
Power Supply Rejection Ratio	PSRR	Ripple 0.5Vp-p, $f=10kHz$ $V_{IN}=3.8V$		70		dB
Output Voltage Temperature Coefficient	$\Delta V_{OUT}/\Delta T$	$I_{OUT}=30mA$		± 280		$\mu V/^{\circ}C$
	$(\Delta V_{OUT}/V_{OUT})/\Delta T$			± 100		ppm/ $^{\circ}C$
Short Current Limit	I_{LIMIT}	$V_{OUT}=0V$		50		mA
RMS Output Noise	V_{NOISE}	$T_A=25^{\circ}C$ $10Hz \leq f \leq 100kHz$		30		μV_{rms}
CE "High" Voltage		CE input voltage "High"	1.5			V
CE "Low" Voltage		CE input voltage "Low"			0.25	V
CE Pull-down Resistance	R_{PD}		2.5	5	10	M Ω

Electrical Characteristics (Continued)

SP6260EEK (3.0V)

($V_{IN}=4V$, $T_J=25^{\circ}C$, $C_{IN}=1\mu F$, $C_{OUT}=1\mu F$, **Bold** typeface applies over $-40^{\circ}C \leq T_J \leq 85^{\circ}C$, unless otherwise specified.)

Parameter	Symbol	Conditions	Min	Typ	Max	Unit
Output Voltage	V_{OUT}	$V_{IN}=4V$ $1mA \leq I_{OUT} \leq 30mA$	2.94	3.0	3.06	V
Input Voltage	V_{IN}				6	V
Output Current	I_{OUT}	$V_{IN}-V_{OUT}=1V$	150			mA
Load Regulation	V_{RLOAD}	$V_{IN}=4V$ $1mA \leq I_{OUT} \leq 80mA$		12	40	mV
Line Regulation	V_{RLINE}	$3.5V \leq V_{IN} \leq 6V$ $I_{OUT}=30mA$		4	16	mV
Dropout Voltage	V_{DROP}	$I_{OUT}=10mA$		20	40	mV
		$I_{OUT}=100mA$		150	300	
		$I_{OUT}=150mA$		200	400	
Quiescent Current	I_Q	$V_{IN}=4V$, $I_{OUT}=0mA$		25	50	μA
Standby Current	I_{STD}	$V_{IN}=4V$ V_{CE} in OFF mode		0.1	1	μA
Power Supply Rejection Ratio	PSRR	Ripple 0.5Vp-p, $f=10kHz$ $V_{IN}=4V$		70		dB
Output Voltage Temperature Coefficient	$\Delta V_{OUT}/\Delta T$	$I_{OUT}=30mA$		± 300		$\mu V/^{\circ}C$
	$(\Delta V_{OUT}/V_{OUT})/\Delta T$			± 100		ppm/ $^{\circ}C$
Short Current Limit	I_{LIMIT}	$V_{OUT}=0V$		50		mA
RMS Output Noise	V_{NOISE}	$T_A=25^{\circ}C$ $10Hz \leq f \leq 100kHz$		30		μV_{rms}
CE "High" Voltage		CE input voltage "High"	1.5			V
CE "Low" Voltage		CE input voltage "Low"			0.25	V
CE Pull-down Resistance	R_{PD}		2.5	5	10	$M\Omega$

Electrical Characteristics (Continued)

SP6260FEK (3.2V)

($V_{IN}=4.2V$, $T_J=25^{\circ}C$, $C_{IN}=1\mu F$, $C_{OUT}=1\mu F$, **Bold** typeface applies over $-40^{\circ}C \leq T_J \leq 85^{\circ}C$, unless otherwise specified.)

Parameter	Symbol	Conditions	Min	Typ	Max	Unit
Output Voltage	V_{OUT}	$V_{IN}=4.2V$ $1mA \leq I_{OUT} \leq 30mA$	3.136	3.2	3.264	V
Input Voltage	V_{IN}				6	V
Output Current	I_{OUT}	$V_{IN}-V_{OUT}=1V$	150			mA
Load Regulation	V_{RLOAD}	$V_{IN}=4.2V$ $1mA \leq I_{OUT} \leq 80mA$		12	40	mV
Line Regulation	V_{RLINE}	$3.7V \leq V_{IN} \leq 6V$ $I_{OUT}=30mA$		4	16	mV
Dropout Voltage	V_{DROP}	$I_{OUT}=10mA$		20	40	mV
		$I_{OUT}=100mA$		150	300	
		$I_{OUT}=150mA$		200	400	
Quiescent Current	I_Q	$V_{IN}=4.2V$, $I_{OUT}=0mA$		25	50	μA
Standby Current	I_{STD}	$V_{IN}=4.2V$ V_{CE} in OFF mode		0.1	1	μA
Power Supply Rejection Ratio	PSRR	Ripple 0.5Vp-p, $f=10kHz$ $V_{IN}=4.2V$		70		dB
Output Voltage Temperature Coefficient	$\Delta V_{OUT}/\Delta T$	$I_{OUT}=30mA$		± 320		$\mu V/^{\circ}C$
	$(\Delta V_{OUT}/V_{OUT})/\Delta T$			± 100		ppm/ $^{\circ}C$
Short Current Limit	I_{LIMIT}	$V_{OUT}=0V$		50		mA
RMS Output Noise	V_{NOISE}	$T_A=25^{\circ}C$ $10Hz \leq f \leq 100kHz$		30		μV_{rms}
CE "High" Voltage		CE input voltage "High"	1.5			V
CE "Low" Voltage		CE input voltage "Low"			0.25	V
CE Pull-down Resistance	R_{PD}		2.5	5	10	$M\Omega$

Electrical Characteristics (Continued)

SP6260GEK (3.3V)

($V_{IN}=4.3V$, $T_J=25^{\circ}C$, $C_{IN}=1\mu F$, $C_{OUT}=1\mu F$, **Bold** typeface applies over $-40^{\circ}C \leq T_J \leq 85^{\circ}C$, unless otherwise specified.)

Parameter	Symbol	Conditions	Min	Typ	Max	Unit
Output Voltage	V_{OUT}	$V_{IN}=4.3V$ $1mA \leq I_{OUT} \leq 30mA$	3.234	3.3	3.366	V
Input Voltage	V_{IN}				6	V
Output Current	I_{OUT}	$V_{IN}-V_{OUT}=1V$	150			mA
Load Regulation	V_{RLOAD}	$V_{IN}=4.3V$ $1mA \leq I_{OUT} \leq 80mA$		12	40	mV
Line Regulation	V_{RLINE}	$3.8V \leq V_{IN} \leq 6V$ $I_{OUT}=30mA$		4	16	mV
Dropout Voltage	V_{DROP}	$I_{OUT}=10mA$		20	40	mV
		$I_{OUT}=100mA$		150	300	
		$I_{OUT}=150mA$		200	400	
Quiescent Current	I_Q	$V_{IN}=4.3V$, $I_{OUT}=0mA$		25	50	μA
Standby Current	I_{STD}	$V_{IN}=4.3V$ V_{CE} in OFF mode		0.1	1	μA
Power Supply Rejection Ratio	PSRR	Ripple 0.5Vp-p, $f=10kHz$ $V_{IN}=4.3V$		70		dB
Output Voltage Temperature Coefficient	$\Delta V_{OUT}/\Delta T$	$I_{OUT}=30mA$		± 330		$\mu V/^{\circ}C$
	$(\Delta V_{OUT}/V_{OUT})/\Delta T$			± 100		ppm/ $^{\circ}C$
Short Current Limit	I_{LIMIT}	$V_{OUT}=0V$		50		mA
RMS Output Noise	V_{NOISE}	$T_A=25^{\circ}C$ $10Hz \leq f \leq 100kHz$		30		μV_{rms}
CE "High" Voltage		CE input voltage "High"	1.5			V
CE "Low" Voltage		CE input voltage "Low"			0.25	V
CE Pull-down Resistance	R_{PD}		2.5	5	10	$M\Omega$

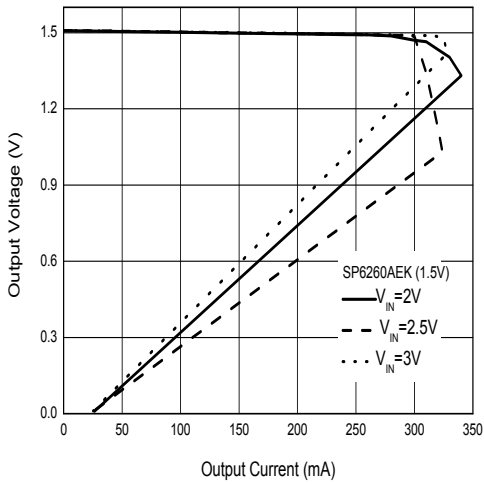

Output Voltage vs. Output Current
SP6260AEK (1.5V)

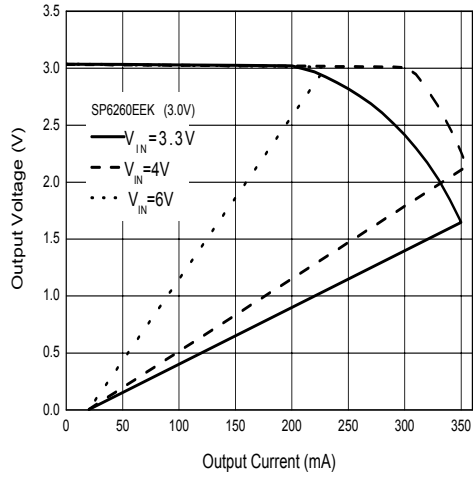

Output Voltage vs. Output Current
SP6260EEK (3.0V)

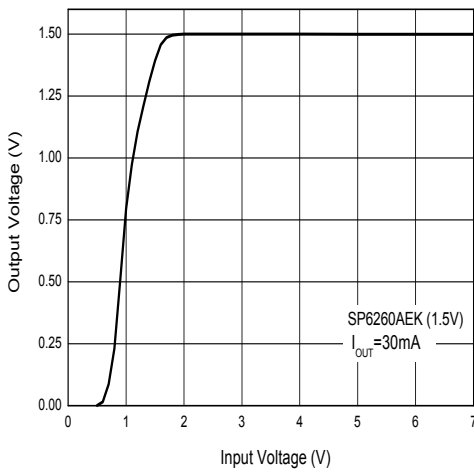

Output Voltage vs. Input Voltage
SP6260AEK (1.5V)

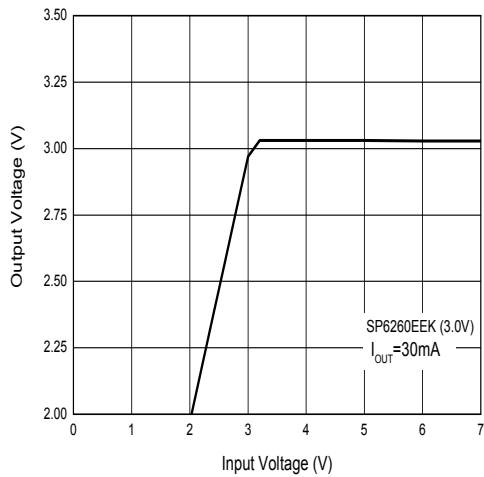

Output Voltage vs. Input Voltage
SP6260EEK (3.0V)

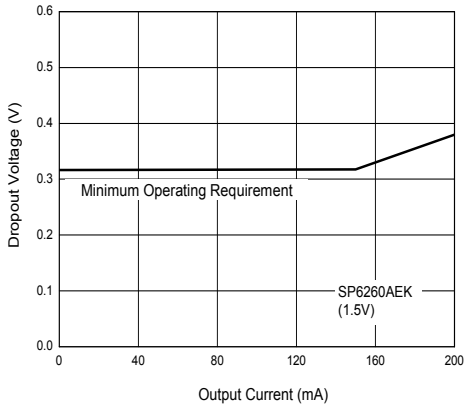

SP6260AEK-L (1.5V) Dropout Voltage vs. Output Current

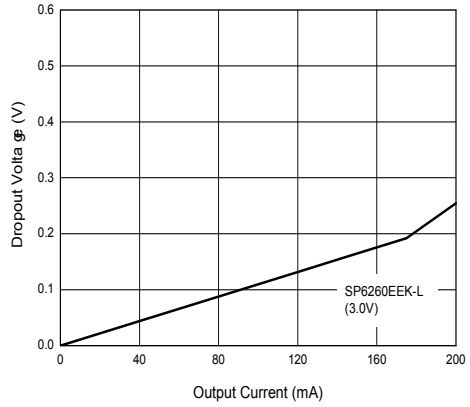

SP6260EEK-L (3.0V) Dropout Voltage vs. Output Current

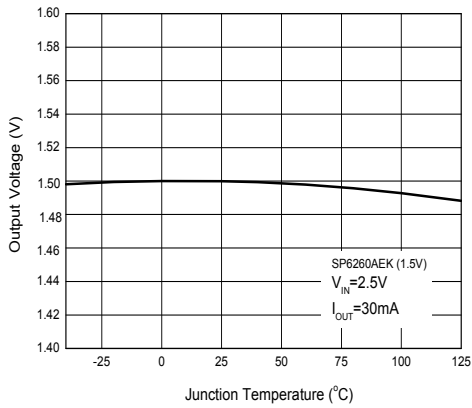

SP6260AEK-L (1.5V) Output Voltage vs. Junction Temperature

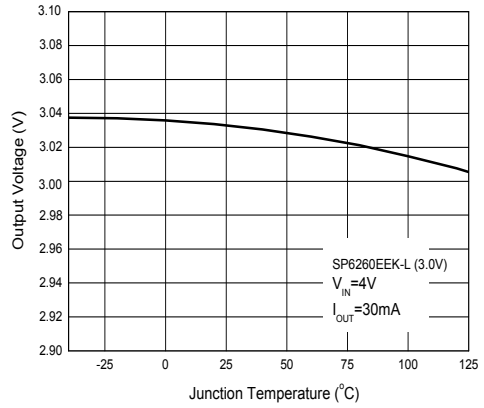

SP6260EEK-L (3.0V) Output Voltage vs. Junction Temperature

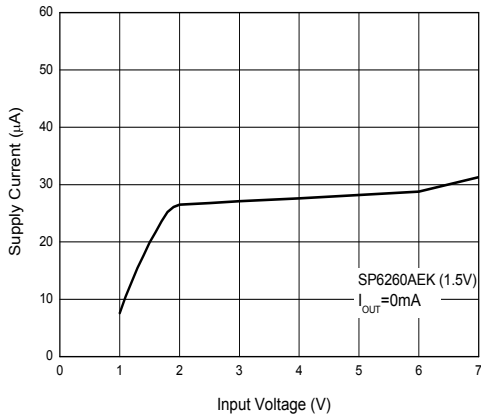

Supply Current vs. Input Voltage
SP6260AEK (1.5V)

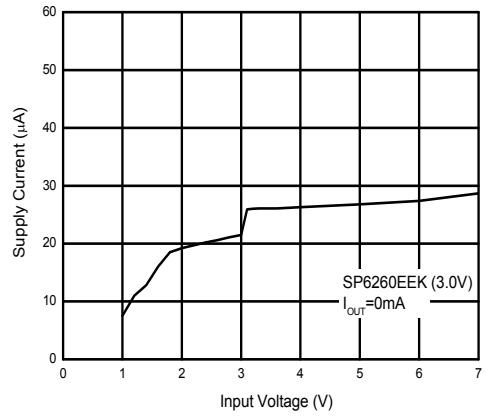

Supply Current vs. Input Voltage
SP6260EEK (3.0V)

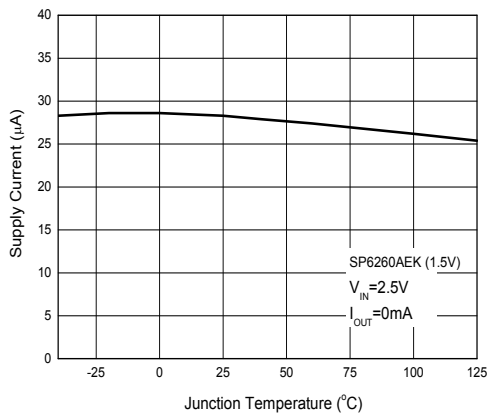

Supply Current vs. Junction Temperature
SP6260AEK (1.5V)

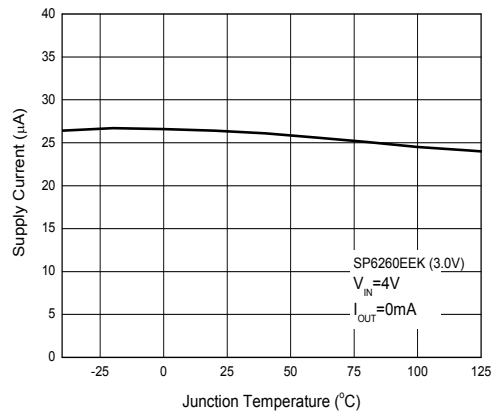

Supply Current vs. Junction Temperature
SP6260EEK (3.0V)

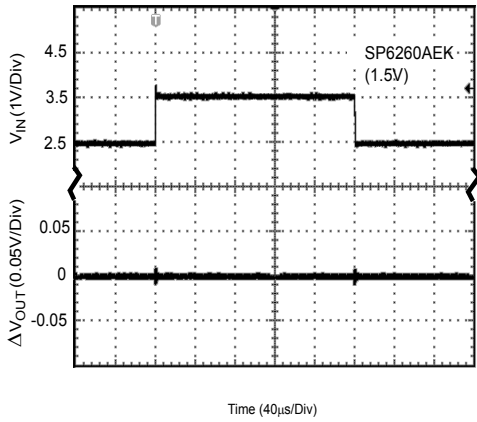

SP6260AEK (1.5V) Line Transient
(Conditions: $I_{OUT}=30\text{mA}$, $C_{IN}=1\mu\text{F}$, $C_{OUT}=1\mu\text{F}$)

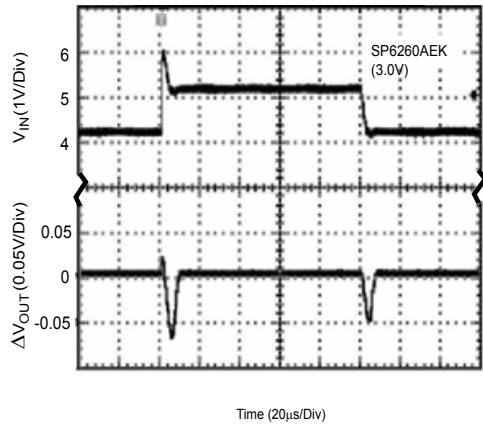

SP6260EEK (3.0V) Line Transient
(Conditions: $I_{OUT}=30\text{mA}$, $C_{IN}=1\mu\text{F}$, $C_{OUT}=1\mu\text{F}$)

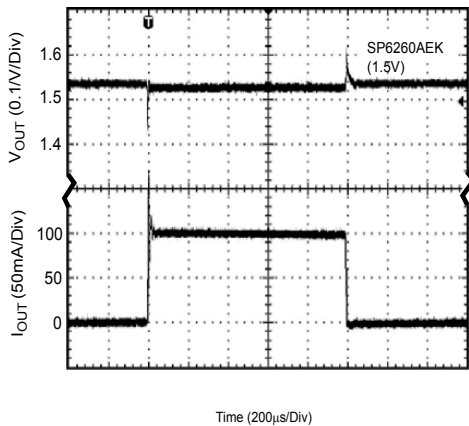

SP6260AEK (1.5V) Load Transient
(Conditions: $V_{IN}=2.5\text{V}$, $C_{IN}=1\mu\text{F}$, $C_{OUT}=1\mu\text{F}$)

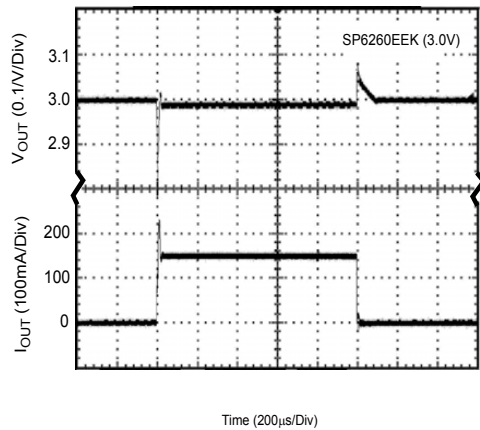

SP6260EEK (3.0V) Load Transient
(Conditions: $V_{IN}=4\text{V}$, $C_{IN}=1\mu\text{F}$, $C_{OUT}=1\mu\text{F}$)

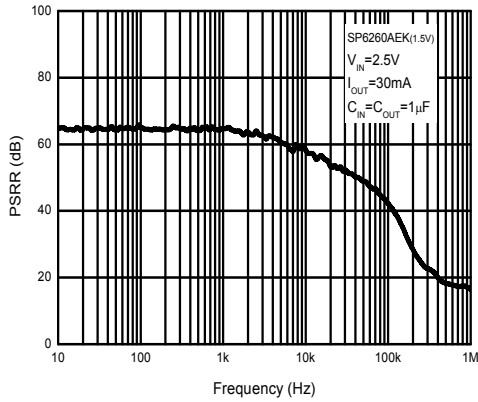

PSRR vs. Frequency
 SP6260AEK (1.5V)

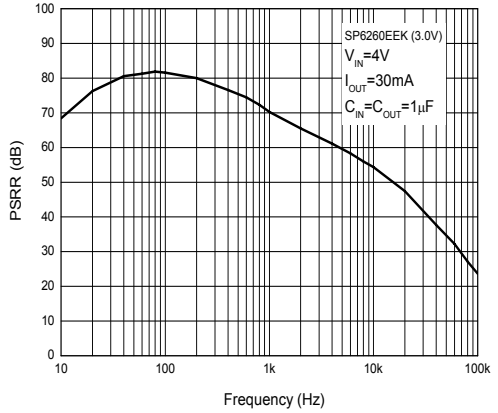

PSRR vs. Frequency
 SP6260EEK (3.0V)

REVISION HISTORY			
REV.	DESCRIPTION	DATE	APP'D
A	DRAWING ORIGINATION	10/3/05	JL
B	DRAWING FORMAT MODIFICATION	07/25/06	JL

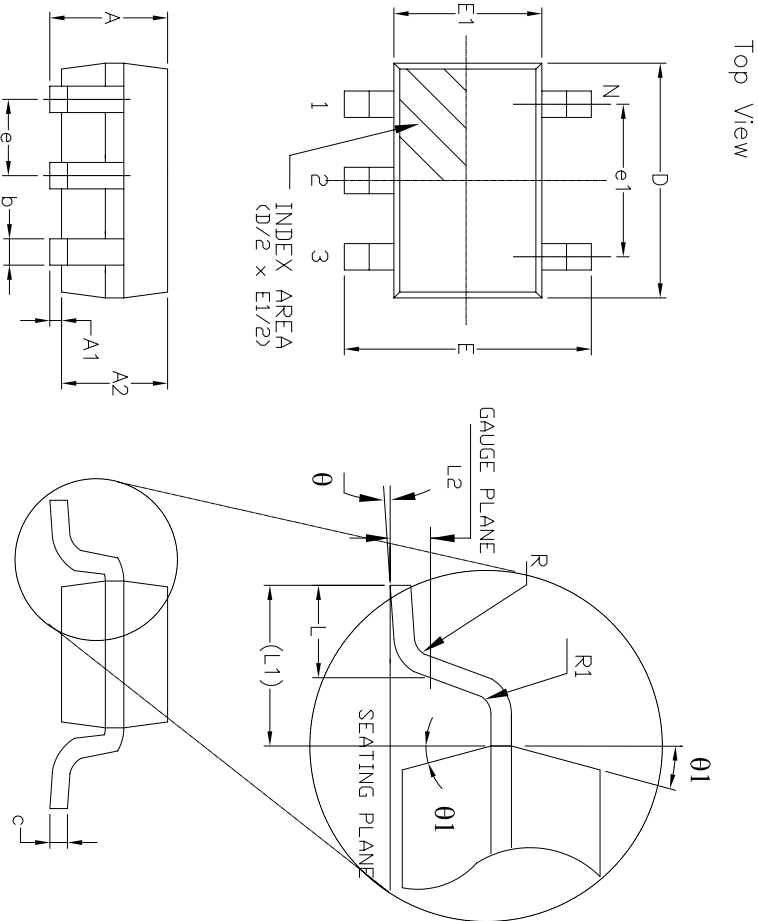

SYMBOLS	DIMENSIONS IN MM (Control Unit)			DIMENSIONS IN INCH (Reference Unit)		
	MIN	NOM	MAX	MIN	NOM	MAX
A	—	1.45	—	—	0.057	—
A1	0.00	0.15	0.000	—	0.006	—
A2	0.90	1.15	1.30	0.036	0.045	0.051
b	0.30	—	0.50	0.012	—	0.020
c	0.08	—	0.22	0.003	—	0.009
D	2.90 BSC			0.115 BSC		
E	2.80 BSC			0.111 BSC		
E1	1.60 BSC			0.063 BSC		
e	0.95 BSC			0.038 BSC		
e1	1.90 BSC			0.075 BSC		
L	0.30 0.45 0.60			0.012 0.018 0.024		
L1	0.60 REF			0.024 REF		
L2	0.25 BSC			0.010 BSC		
R	0.10			0.004		
R1	0.10			0.004		
theta	0°			4°		
theta1	5°			10°		
N	5			5		

Side View

Front View

		SIPLEX CORPORATION	
Packaging Approval:	Date: 07/25/06	Drawing No.:	Revision: B
By: JL	Sheet: 1 OF 1	5-PIN SOT-23	

Part Number	Voltage	Voltage Accuracy	Operating Temperature Range	Package	Marking	Pack Qty
SP6260AEK-L/TR	1.5V	± 2%	-40°C to +85°C	Lead Free 5 Pin SOT-23	DBWW	3,000 Tape & Reel
SP6260BEK-L/TR	1.8V	± 2%	-40°C to +85°C	Lead Free 5 Pin SOT-23	EBWW	3,000 Tape & Reel
SP6260CEK-L/TR	2.5V	± 2%	-40°C to +85°C	Lead Free 5 Pin SOT-23	FBWW	3,000 Tape & Reel
SP6260DEK-L/TR	2.8V	± 2%	-40°C to +85°C	Lead Free 5 Pin SOT-23	GBWW	3,000 Tape & Reel
SP6260EEK-L/TR	3.0V	± 2%	-40°C to +85°C	Lead Free 5 Pin SOT-23	HBWW	3,000 Tape & Reel
SP6260FEK-L/TR	3.2V	± 2%	-40°C to +85°C	Lead Free 5 Pin SOT-23	JBWW	3,000 Tape & Reel
SP6260GEK-L/TR	3.3V	± 2%	-40°C to +85°C	Lead Free 5 Pin SOT-23	KBWW	3,000 Tape & Reel

For further assistance:

Email: Sipexsupport@sipex.com

WWW Support page: <http://www.sipex.com/content.aspx?p=support>

Sipex Application Notes: <http://www.sipex.com/applicationNotes.aspx>



Sipex Corporation

Headquarters and
Sales Office

233 South Hillview Drive
Milpitas, CA 95035
TEL: (408) 934-7500
FAX: (408) 935-7600

Sipex Corporation reserves the right to make changes to any products described herein. Sipex does not assume any liability arising out of the application or use of any product or circuit described herein; neither does it convey any license under its patent rights nor the rights of others.