

Electrical and Optical Characteristics (Tc = 25°C)

Tc: Case temperature

Item		Symbol	Conditions	Min.	Typ.	Max.	Unit
Threshold current		I _{th}			50	65	mA
Operating current		I _{op}	P _o = 5mW		60	70	mA
Operating voltage		V _{op}	P _o = 5mW		2.3	2.8	V
Wavelength		λ	P _o = 5mW	640	650	660	nm
Radiation angle	Perpendicular	θ _⊥	P _o = 5mW	24	30	40	degree
	Parallel	θ _{//}		6	8	12	degree
Positional accuracy	Position	ΔX, ΔY, ΔZ	P _o = 5mW			±80	μm
	Angle	Δφ _{//}				±2	degree
		Δφ _⊥				±3	degree
Differential efficiency		η _D	P _o = 5mW	0.15	0.4	0.7	mW/mA
Astigmatism		A _s	P _o = 5mW		7	15	μm
Monitor current		I _{mon}	P _o = 5mW, V _R = 5V	0.05	0.1	0.3	mA

Handling Precautions

(1) Eye protection against laser beams

The optical output of laser diodes ranges from several mW to 4W. However the optical power density of the laser beam at the diode chip reaches 1MW/cm². Unlike gas lasers, since laser diode beams are divergent, uncollimated laser diode beams are fairly safe at a laser diode. For observing laser beams, ALWAYS use safety goggles that block infrared rays. Usage of IR scopes, IR cameras and fluorescent plates is also recommended for monitoring laser beams safely.

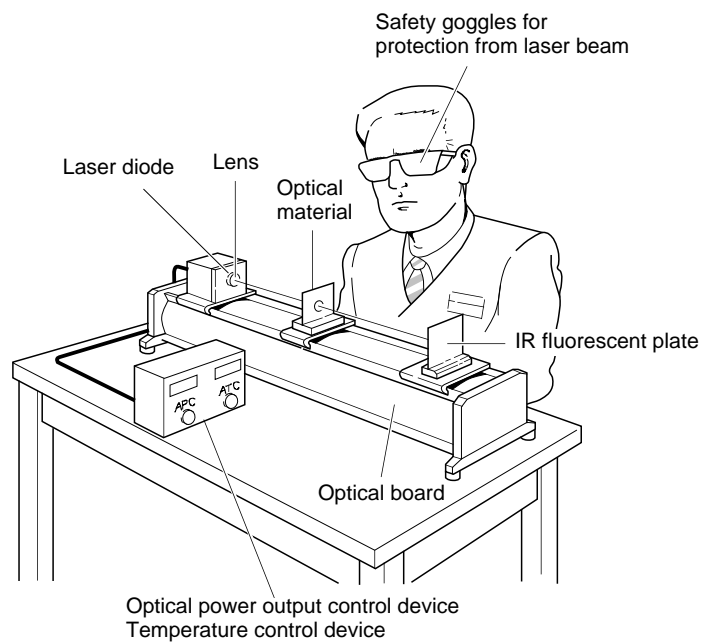

(2) Prevention of surge current and electrostatic discharge

Laser diode is most sensitive to electrostatic discharge among semiconductors. When a large current is passed through the laser diode even for an extremely short time (in the order of nanosecond), the strong light emitted from the laser diode promotes deterioration and then laser diodes are destroyed. Therefore, note that the surge current should not flow the laser diode driving circuit from switches and others. Also, if the laser diode is handled carelessly, it may be destructed instantly because electrostatic discharge is easily applied by a human body. Be great careful about excess current and electrostatic discharge.

Example of Representative Characteristics

Optical power output vs. Forward current characteristics
Optical power output vs. Monitor current characteristics

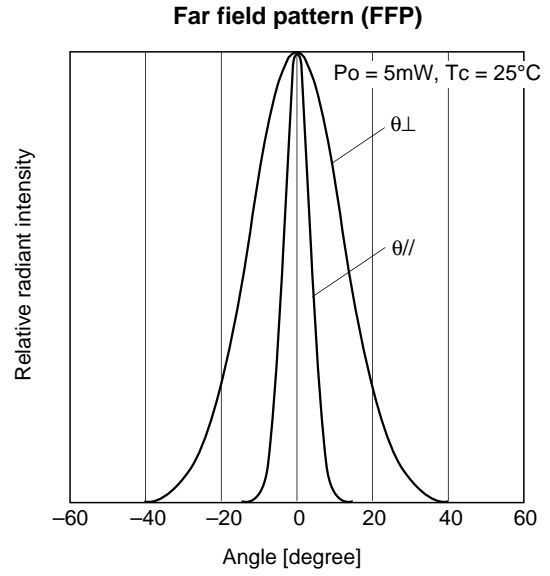
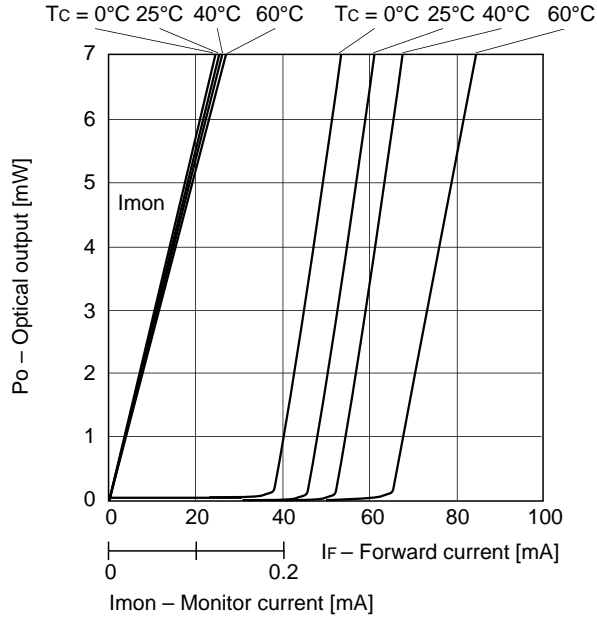

Threshold current vs. Temperature characteristics

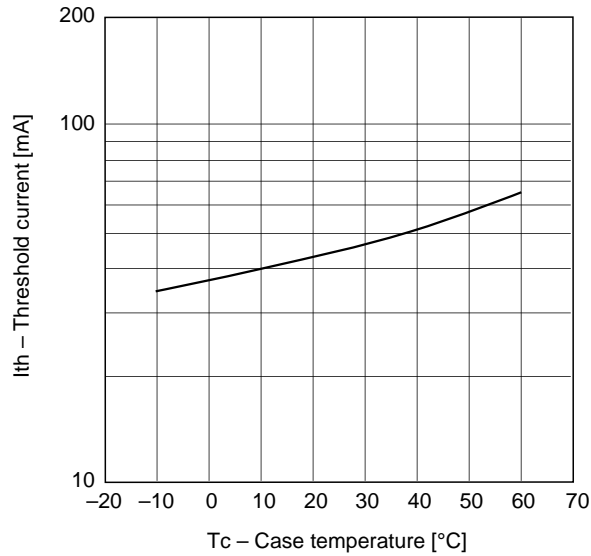

Monitor current vs. Temperature characteristics

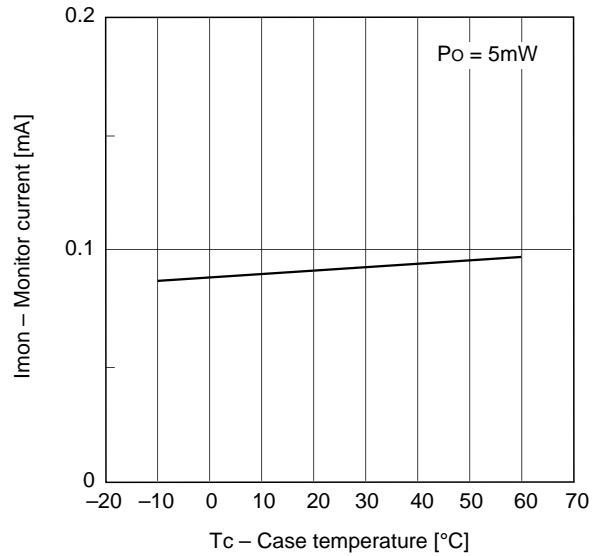

Temperature dependence of spectrum

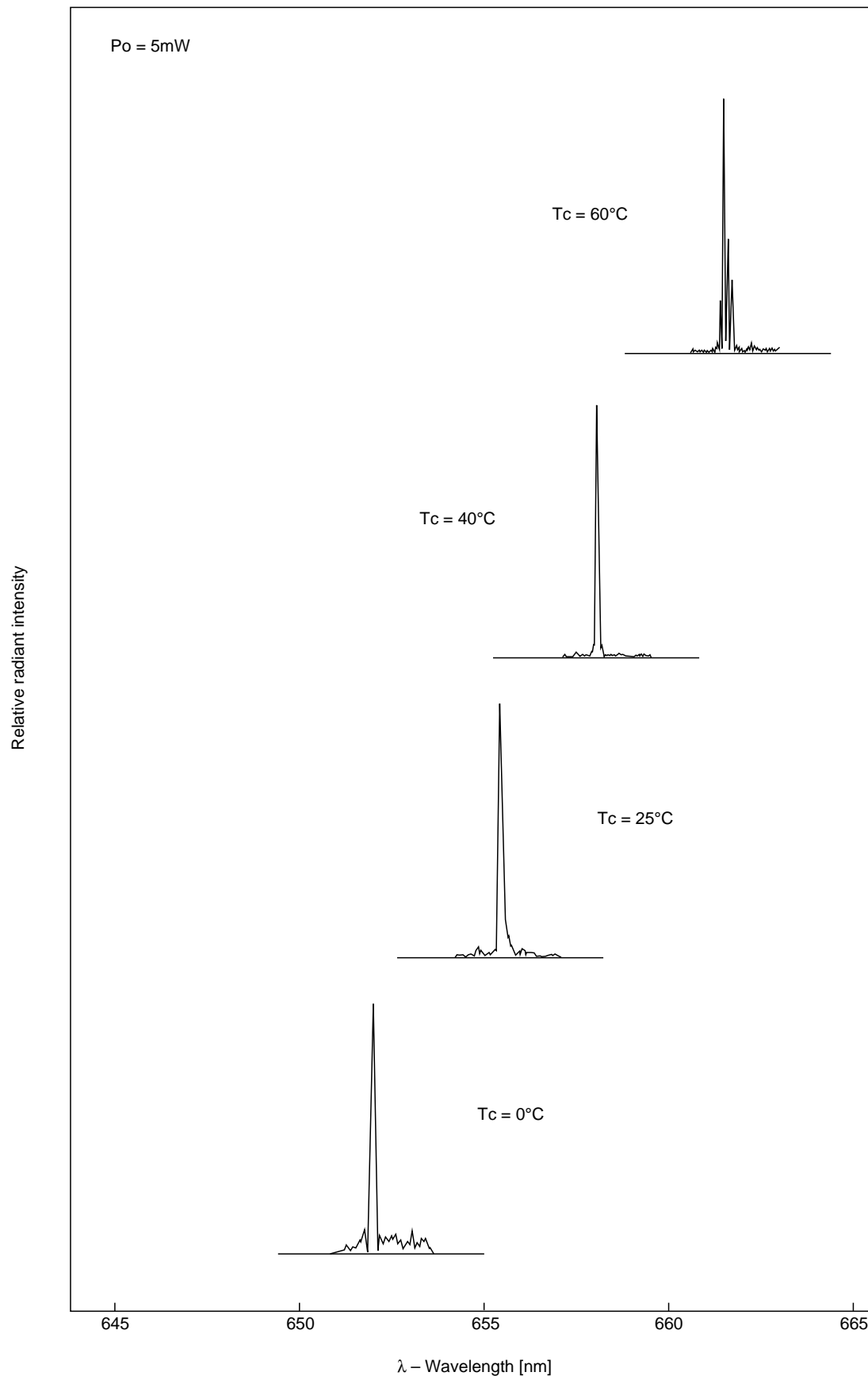

Power output dependence of spectrum

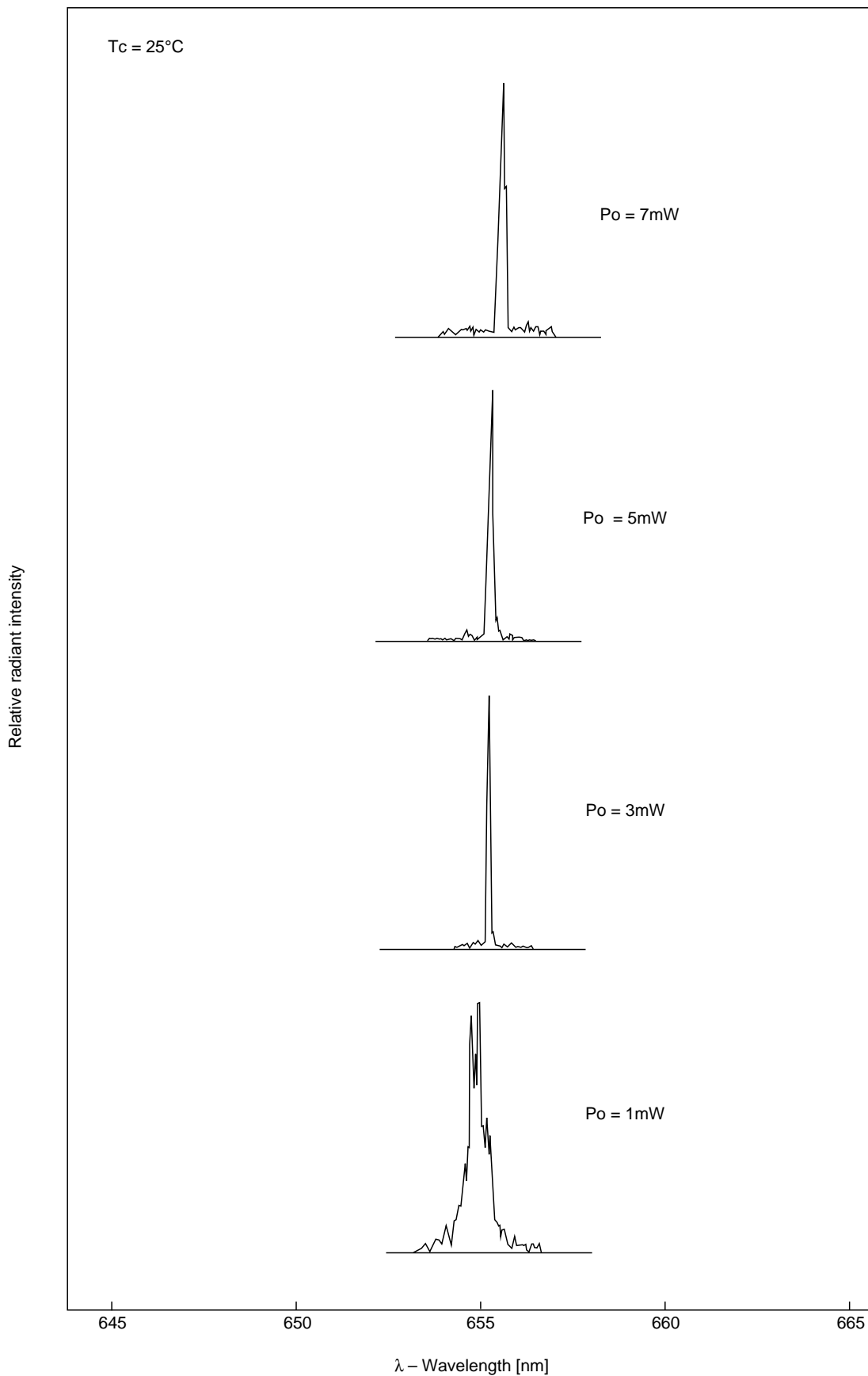

Package Outline

Unit: mm

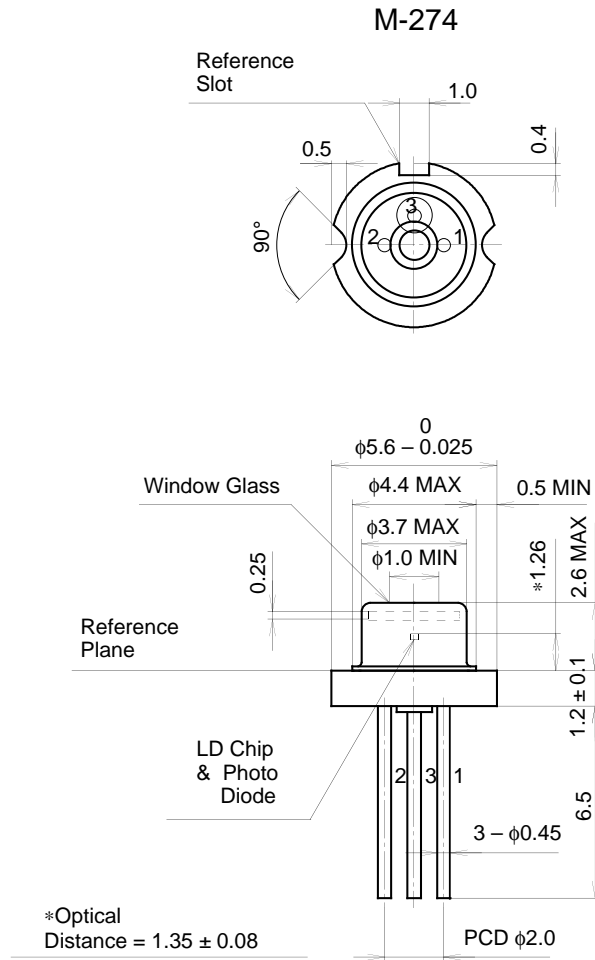

SONY CODE	M-274
EIAJ CODE	_____
JEDEC CODE	_____

PACKAGE WEIGHT	0.3g
----------------	------