



P-Channel 60-V (D-S) MOSFET

PRODUCT SUMMARY		
V_{DS} (V)	$r_{DS(on)}$ (Ω)	I_D (A)
-60	0.115 @ $V_{GS} = -10$ V	-2.7
	0.150 @ $V_{GS} = -4.5$ V	-2.4

FEATURES

- TrenchFET® Power MOSFET

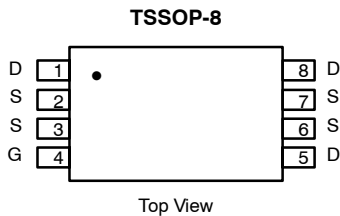

Ordering Information: Si6459BDQ-T1

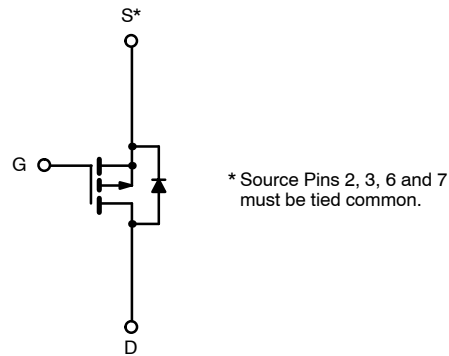

P-Channel MOSFET

ABSOLUTE MAXIMUM RATINGS ($T_A = 25^\circ\text{C}$ UNLESS OTHERWISE NOTED)				
Parameter	Symbol	10 secs	Steady State	Unit
Drain-Source Voltage	V_{DS}	-60		V
Gate-Source Voltage	V_{GS}	± 20		
Continuous Drain Current ($T_J = 150^\circ\text{C}$) ^a	I_D	$T_A = 25^\circ\text{C}$	-2.7	-2.2
		$T_A = 70^\circ\text{C}$	-2.2	-1.8
Pulsed Drain Current (10 μs Pulse Width)	I_{DM}	-20		A
Continuous Source Current (Diode Conduction) ^a	I_S	-1.25	-0.83	
Avalanche Current	I_{AS}	15		
Single Pulse Avalanche Energy	E_{AS}	11		mJ
Maximum Power Dissipation ^a	P_D	$T_A = 25^\circ\text{C}$	1.50	1.0
		$T_A = 70^\circ\text{C}$	1.0	0.67
Operating Junction and Storage Temperature Range	T_J, T_{stg}	-55 to 150		$^\circ\text{C}$

THERMAL RESISTANCE RATINGS				
Parameter	Symbol	Typical	Maximum	Unit
Maximum Junction-to-Ambient ^a	R_{thJA}	$t \leq 10$ sec	66	83
		Steady State	100	120
Maximum Junction-to-Foot	R_{thJF}	50	60	$^\circ\text{C}/\text{W}$

Notes

a. Surface Mounted on 1" x 1" FR4 Board.

SPECIFICATIONS (T_J = 25 °C UNLESS OTHERWISE NOTED)

Parameter	Symbol	Test Condition	Min	Typ	Max	Unit
Static						
Gate Threshold Voltage	V _{GS(th)}	V _{DS} = V _{GS} , I _D = -250 μA	-1		-3	V
Gate-Body Leakage	I _{GSS}	V _{DS} = 0 V, V _{GS} = ±20 V			±100	nA
Zero Gate Voltage Drain Current	I _{DSS}	V _{DS} = -60 V, V _{GS} = 0 V			-1	μA
		V _{DS} = -60 V, V _{GS} = 0 V, T _J = 70 °C			-10	
On-State Drain Current ^a	I _{D(on)}	V _{DS} = -5 V, V _{GS} = -10 V	-20			A
Drain-Source On-State Resistance ^a	r _{DS(on)}	V _{GS} = -10 V, I _D = -2.7 A		0.092	0.115	Ω
		V _{GS} = -4.5 V, I _D = -2.4 A		0.120	0.150	
Forward Transconductance ^a	g _{fs}	V _{DS} = -15 V, I _D = -2.7 A		8		S
Diode Forward Voltage ^a	V _{SD}	I _S = -1.25 A, V _{GS} = 0 V		-0.8	-1.2	V
Dynamic^b						
Total Gate Charge	Q _g	V _{DS} = -30 V, V _{GS} = -10 V, I _D = -2.7 A		14.5	22	nC
Gate-Source Charge	Q _{gs}			2.2		
Gate-Drain Charge	Q _{gd}			3.7		
Gate Resistance	R _g			14		Ω
Turn-On Delay Time	t _{d(on)}	V _{DD} = -30 V, R _L = 30 Ω I _D ≅ -1 A, V _{GEN} = -10 V, R _G = 6 Ω		10	15	ns
Rise Time	t _r			15	22	
Turn-Off Delay Time	t _{d(off)}			50	75	
Fall Time	t _f			35	55	
Source-Drain Reverse Recovery Time	t _{rr}	I _F = -1.25 A, di/dt = 100 A/μs		30	50	

Notes

- a. Pulse test; pulse width ≤ 300 μs, duty cycle ≤ 2%.
b. Guaranteed by design, not subject to production testing.

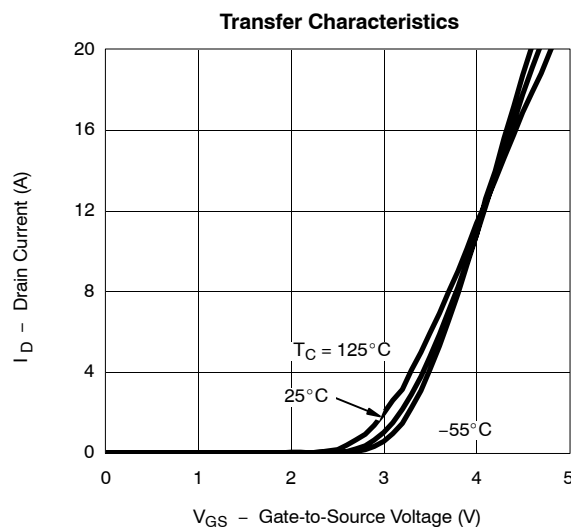
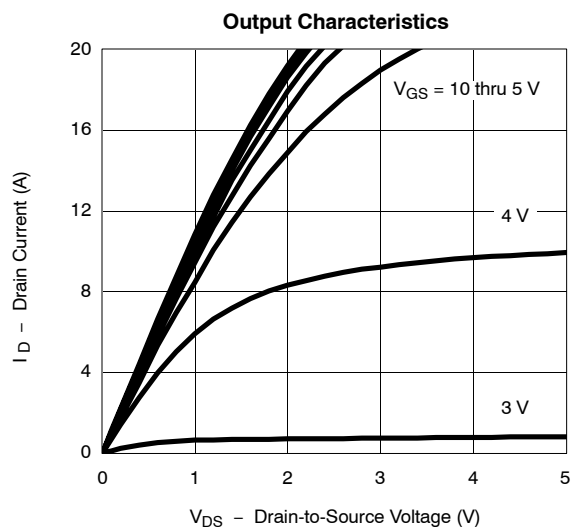
TYPICAL CHARACTERISTICS (25 °C UNLESS NOTED)



TYPICAL CHARACTERISTICS (25 °C UNLESS NOTED)

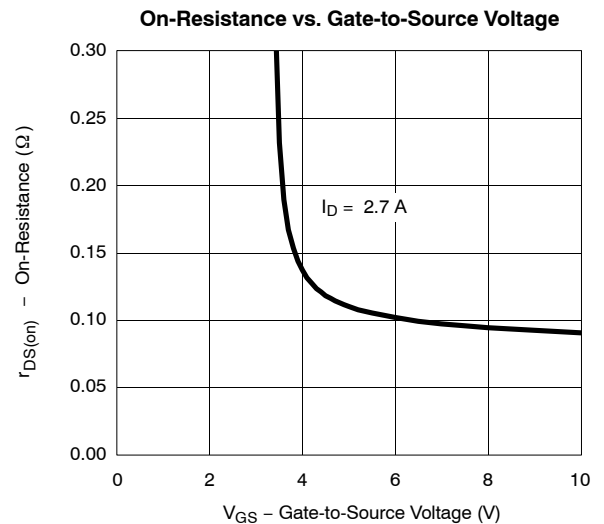
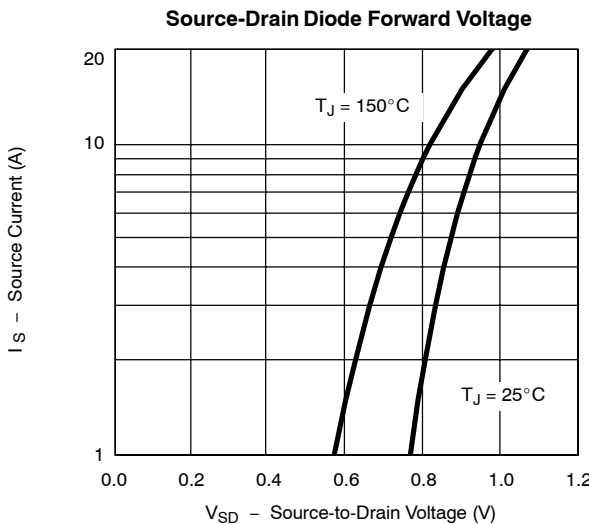
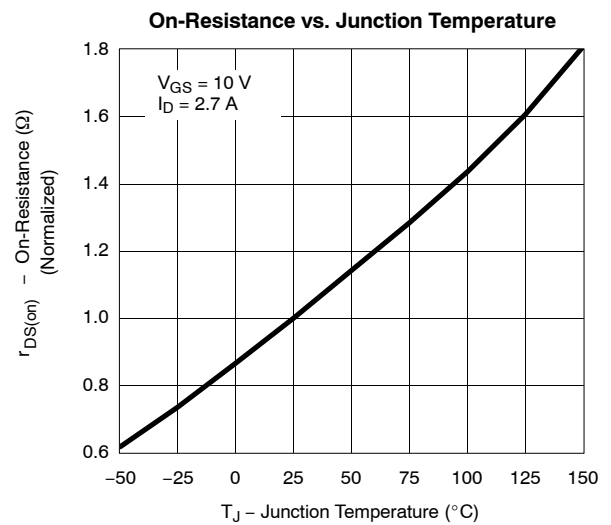
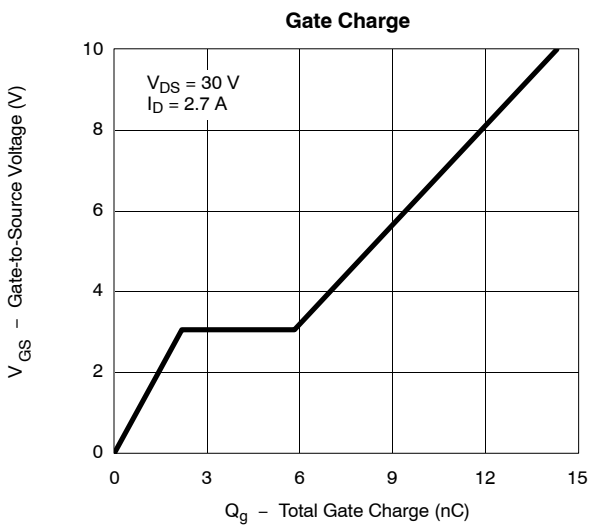
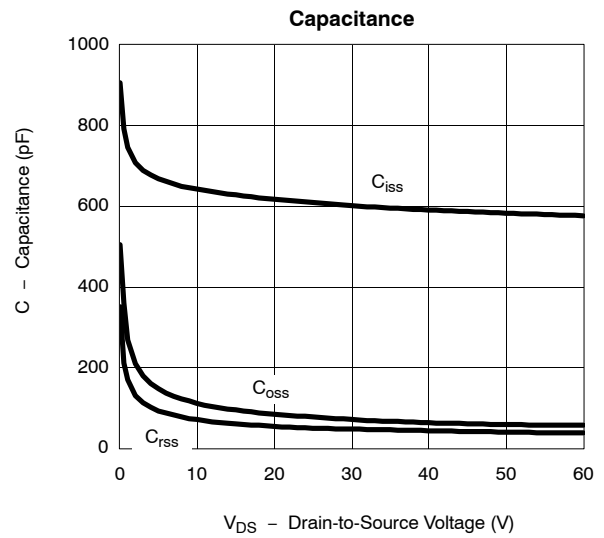
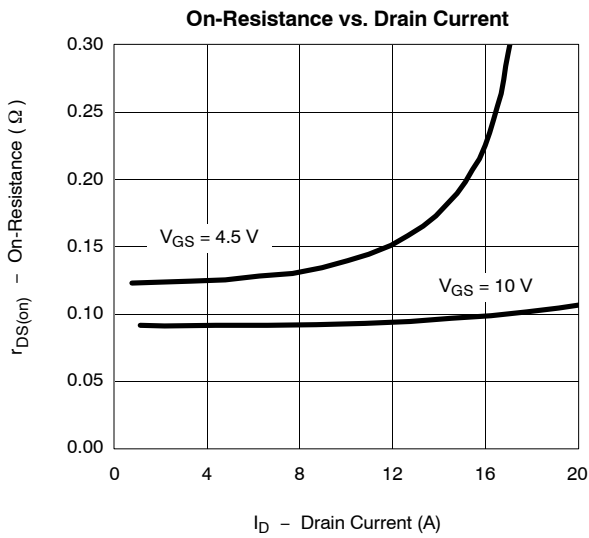

TYPICAL CHARACTERISTICS (25 °C UNLESS NOTED)

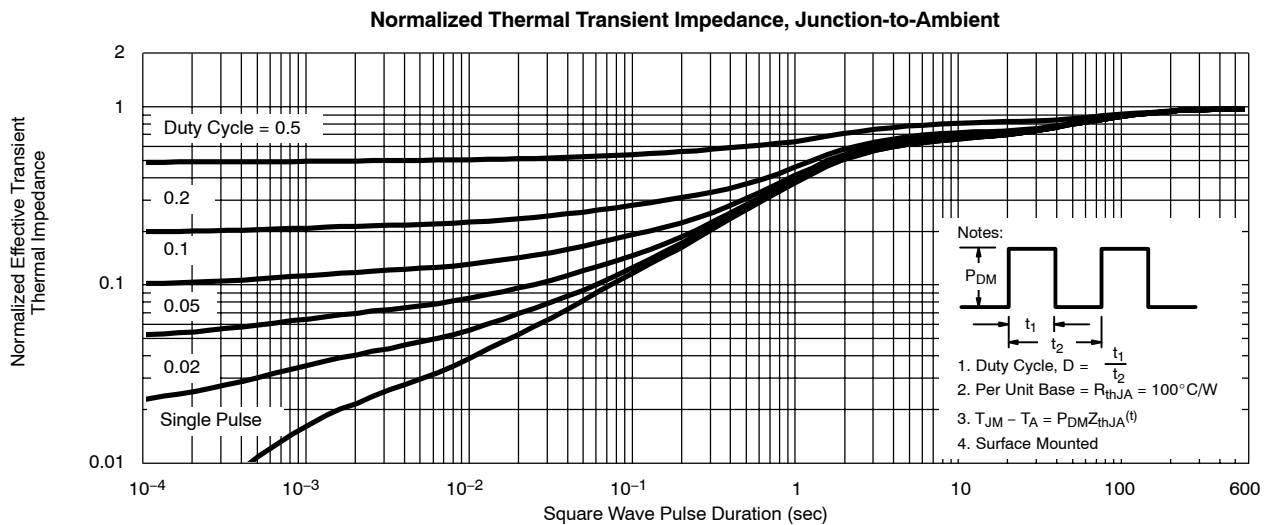
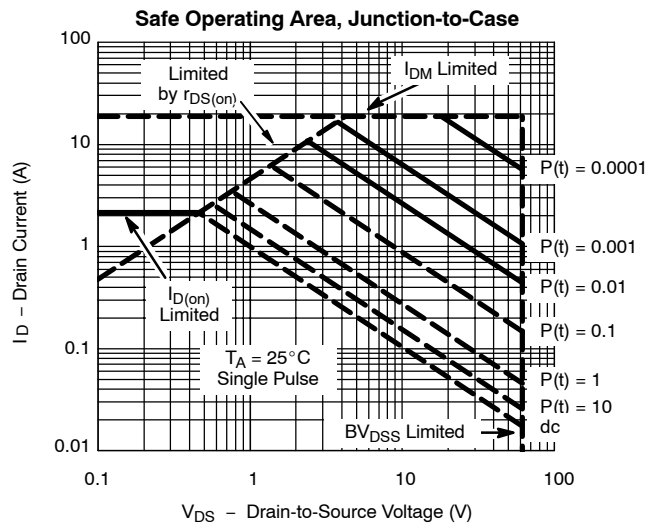
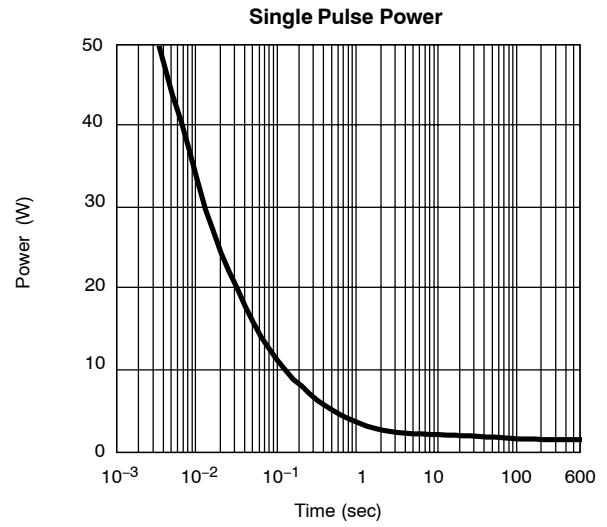
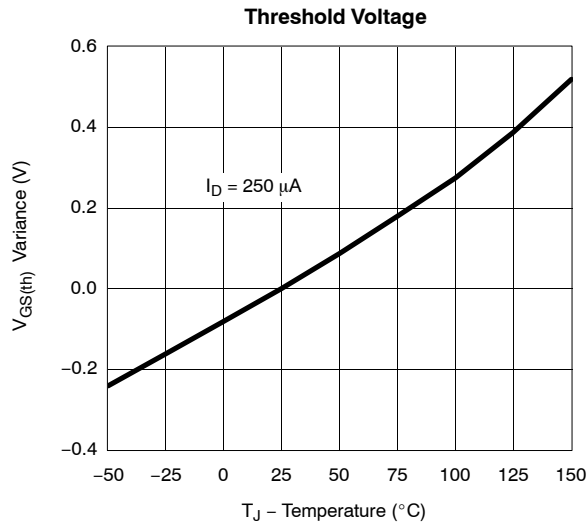



TYPICAL CHARACTERISTICS (25 °C UNLESS NOTED)

