

1. Test conditions

RF power	0	dBm
Room Temperature	23	°C
Terminating source impedance (ZS):	50	Ω
Terminating load impedance (ZL):	50	Ω

2. Specifications

	Minimum	Typical	Maximum	Unit
Centre frequency		454.99		MHz
Pass Band	452.5		457.48	MHz
Insertion Loss in Pass Band		2.0	2.8	dB
VSWR in Pass Band		1.2:1	1.4:1	
Absolute Rejection 0.3 MHz – 442.5MHz	30	32		dB
RX Rejection 462.5 MHz – 467.48 MHz	35	45		dB
462.5 MHz – 467.48 MHz *)	40	45		dB
Rejection 900 MHz Cellular 467.48 MHz – 1565 MHz	30	34		dB
Rejection GPS Band 1565 MHz – 1585 MHz	30	37		dB
Rejection PCS DCS UMTS 1585 MHz – 1800 MHz	30	37		dB
Operating temperature range	-30		+85	°C
Temperature coefficient of frequency		-30		ppm/°C
Input Power			27	dBm

*) Temperature Range: -10 ... +60°C

3. Matching Network

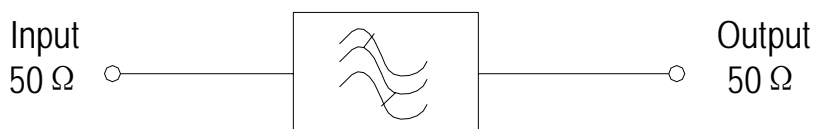

	SIPAT Co., Ltd. (CETC No. 26 Research Institute) Nanping Huayuan Road No. 14 Chongqing, China, 400060	Part Number	SF455A	
		Rev. Date	2005-2-14	
		Rev.	PR6.0	Page

6. Typical Performance

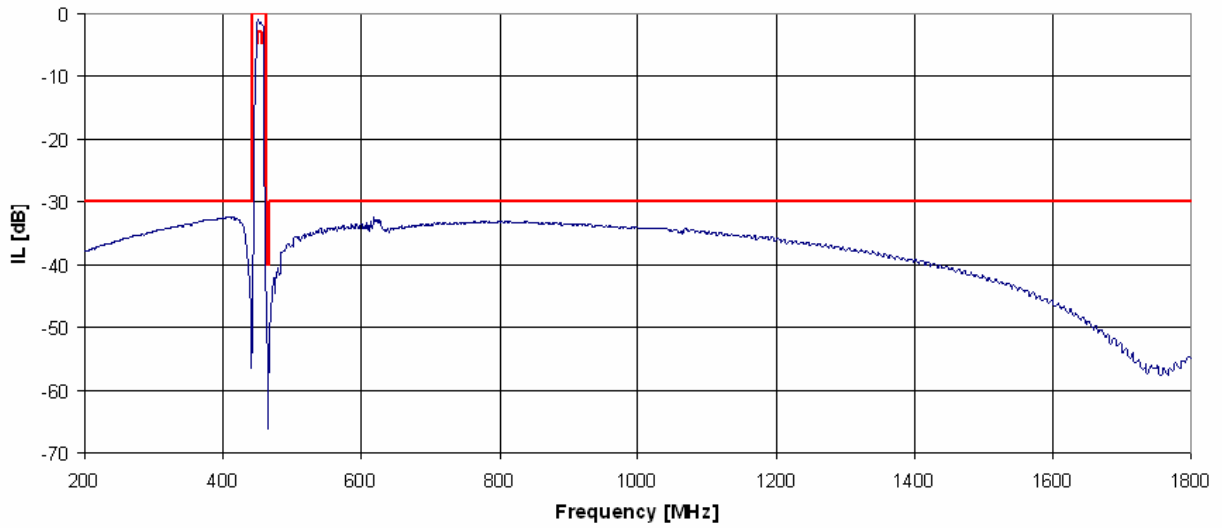
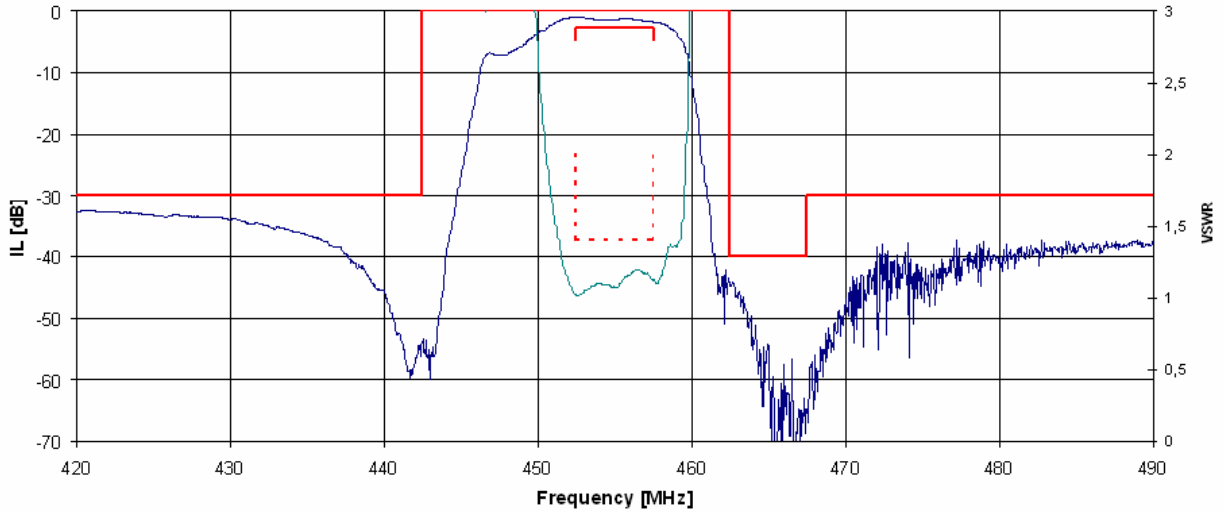

	SIPAT Co., Ltd. (CETC No. 26 Research Institute) Nanping Huayuan Road No. 14 Chongqing, China, 400060	Part Number	SF455A
		Rev. Date	2005-2-14
		Rev.	PR6.0

7. Packing

1. Reeling Quantity : 3000 pcs / 13" reel (or 1000 pcs / 7" reel)
2. Taping Structure : The tape shall be wound around the reel in the direction shown below.

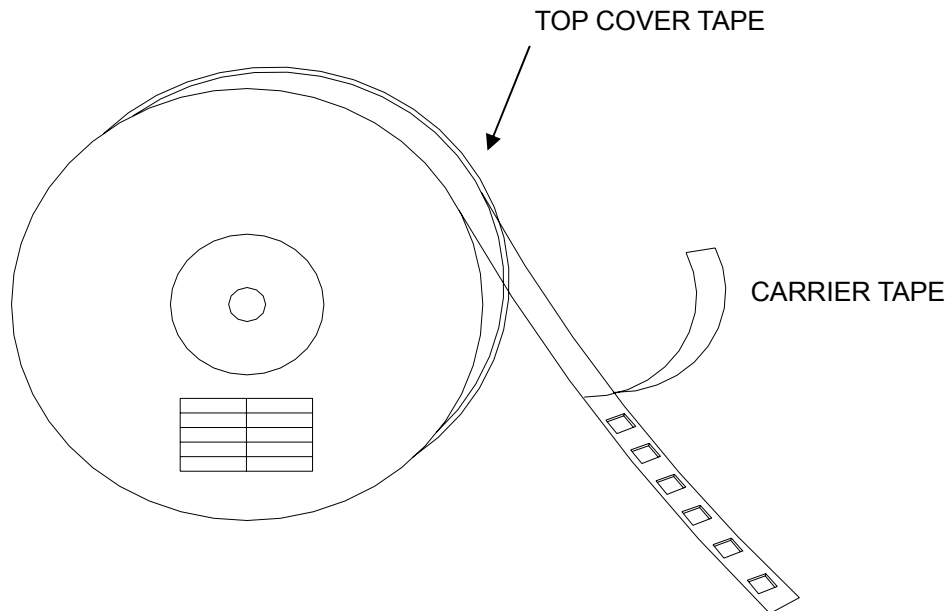
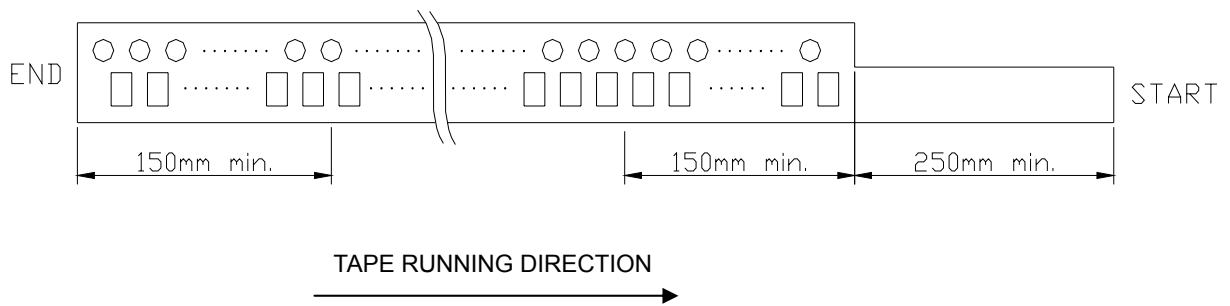

	SIPAT Co., Ltd. (CETC No. 26 Research Institute) Nanping Huayuan Road No. 14 Chongqing, China, 400060	Part Number	SF455A	
		Rev. Date	2005-2-14	
		Rev.	PR6.0	Page

3. Top Cover Tape Adhesion (See the below figure)

- (1) pull off angle: 0~15°
- (2) speed: 300mm/min.
- (3) force: 20~70g

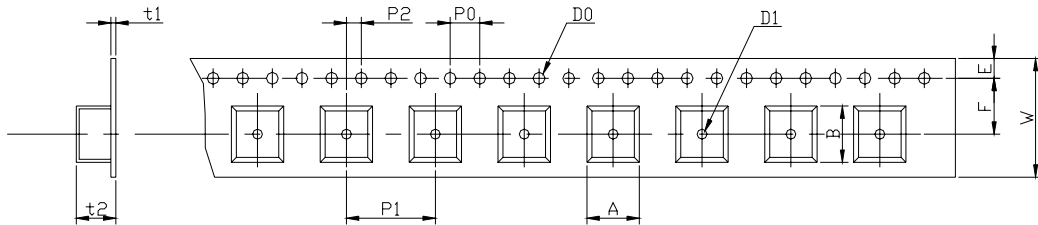
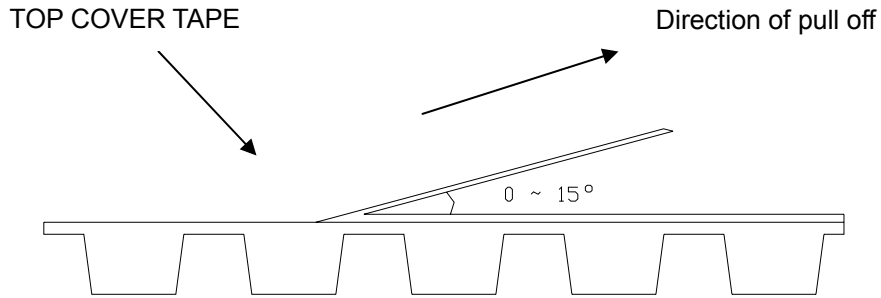

W	F	E	P0	P1	P2	D0	D1	t1	t2	A	B
12.0	5.5	1.75	4.0	8.0	2.0	Φ1.5	Φ1.5	0.31	1.95	4.1	4.1
±0.3	±0.1	±0.1	±0.2	±0.1	±0.2	±0.1	±0.25	max.	max.	max.	max.

	SIPAT Co., Ltd. (CETC No. 26 Research Institute) Nanping Huayuan Road No. 14 Chongqing, China, 400060	Part Number	SF455A	
		Rev. Date	2005-2-14	
		Rev.	PR6.0	Page 5/6

4.Reel Dimensions

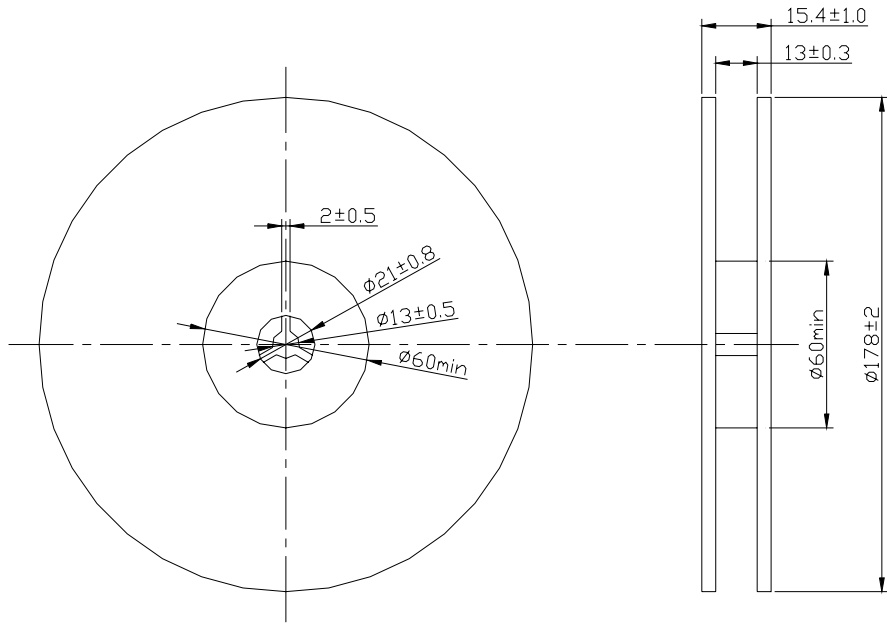

[Unit: mm]

5. Part Direction

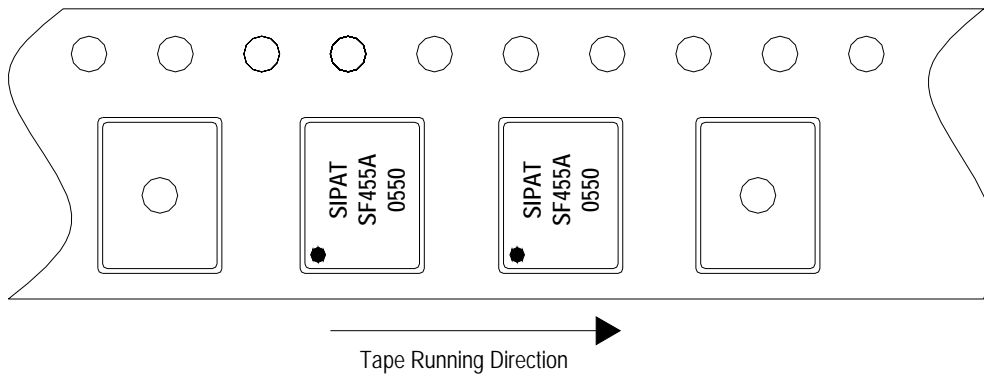

	SIPAT Co., Ltd. (CETC No. 26 Research Institute) Nanping Huayuan Road No. 14 Chongqing, China, 400060	Part Number	SF455A
		Rev. Date	2005-2-14
		Rev.	PR6.0