



EVERLIGHT ELECTRONICS CO.,LTD.

Device Number : DLE-038-159 REV: 1.0

T-1 3/4(5mm) High Intensity LEDs

MODEL NO : 383-2SDRC/S530-A5 ECN : _____ Page: 1/4

Features :

- Popular T-1 3/4 diameter package.
- Choice of various viewing angles.
- Available on tape and reel.
- Reliable and robust.

Description :

- The series is specially designs for applications require higher brightness than that achievable with standard lamp.
- The LED lamps are available with different colors,intensities, epoxy colors, etc.

Package Dimension:

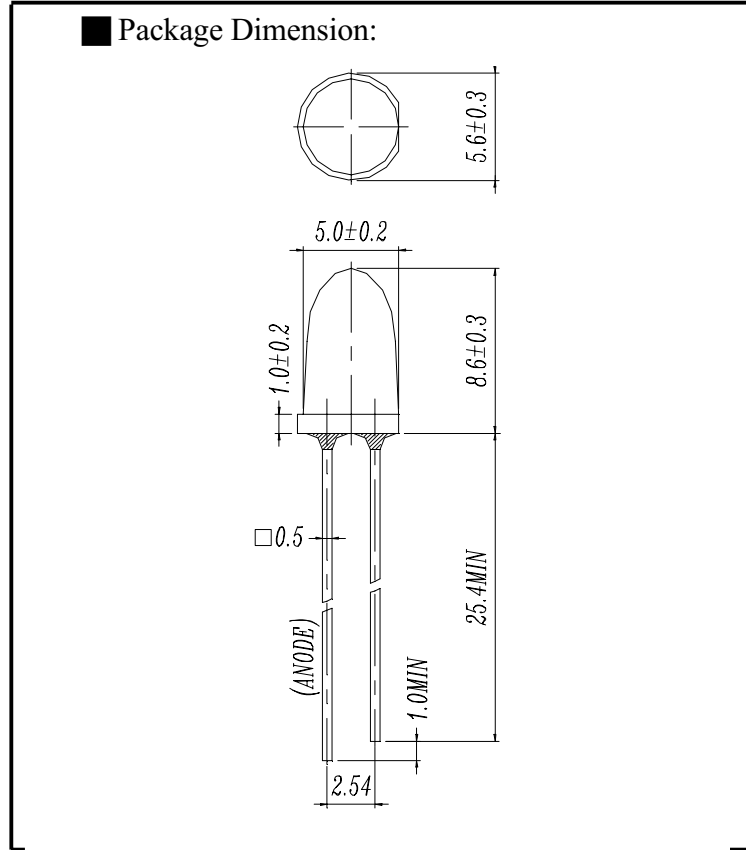

Applications :

- TV Set
- Monitor
- Telephone
- Computer

NOTES :

- 1.All dimensions are in millimeter.
- 2.An epoxy meniscus may extend about 1.5mm(0.059") down to the lead.

| PART NO | CHIP | | Lens Color |
|-------------------|----------|----------------|-------------|
| | Material | Emitted Color | |
| 383-2SDRC/S530-A5 | AlGaInP | Super Deep-Red | Water Clear |

| DESIGNER | CHECKER | APPROVER |
|----------|---------|----------|
| | | |

Office : NO 25,Lane 76,Chung Yang Rd,Sec.3
Tucheng,Taipei 236,Taiwan,R.O.C.

TEL : 886-2-2267-2000,2267-9936(22 Lines)
FAX : 886-2-2267-6189



EVERLIGHT ELECTRONICS CO.,LTD.

Device Number : DLE-038-159 REV: 1.0

T-1 3/4 (5mm) Round Shape LEDs

MODEL NO : 383-2SDRC/S530-A5 ECN : _____ Page: 2/4

■ Absolute Maximum Ratings at Ta = 25°C

| Parameter | Symbol | Rating | Unit |
|--|----------|-------------|------|
| Forward Current | If | 25 | mA |
| Operating Temperature | Topr | -40 to +85 | °C |
| Storage Temperature | Tstg | -40 to +100 | °C |
| Soldering Temperature | Tsol | 260 ± 5 | °C |
| Electrostatic Discharge : | ESD | 2000 | V |
| Power Dissipation | Pd | 60 | mW |
| Peak Forward Current(Duty 1/10 @ 1KHZ) | If(Peak) | 160 | mA |
| Reverse voltage | Vr | 5 | V |

■ Electronic Optical Characteristics :

| Parameter | Symbol | MIN. | TYP. | MAX. | Unit | Condition |
|------------------------------|---------|--------------|-------------|-------|------|-------------------|
| Luminous intensity | Iv | ---- 2590 | 209 3490 | ----- | mcd | If=2mA If=20mA |
| Viewing Angle | 2 θ 1/2 | ---- | 6 | ---- | deg | If=20mA |
| Peak Wavelength | λ p | ---- | 650 | ----- | nm | If=20mA |
| Dominant Wavelength | λ d | ---- | 639 | ---- | nm | If=20mA |
| Spectrum Radiation Bandwidth | △ λ | --- | 20 | ---- | nm | If=20mA |
| Forward Voltage | Vf | ---- | 2.0 | 2.4 | V | If=20mA |
| Reverse Current | Ir | ---- | ---- | 10 | μ A | Vr=5V |



Device Number : DLE-038-159 REV: 1.0

T-1 3/4(5mm) High Intensity LEDs

MODEL NO 383-2SDRC/S530-A5 ECN : _____ Page: 3/4

■ Typical Electro-Optical Characteristic Curves

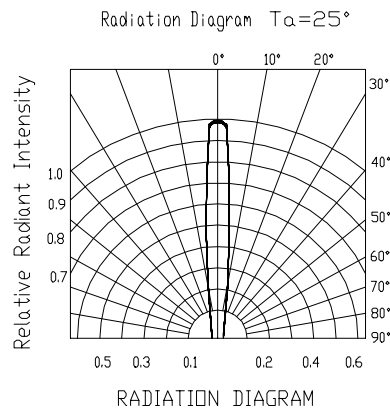
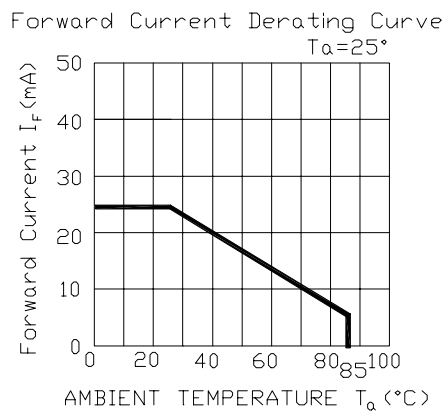
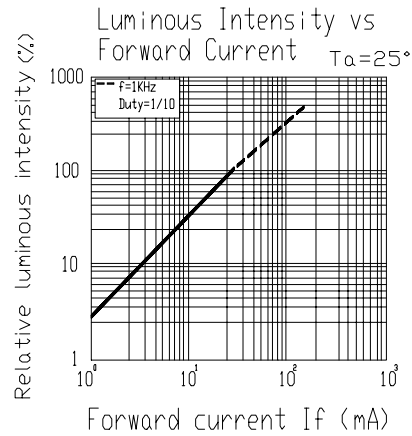
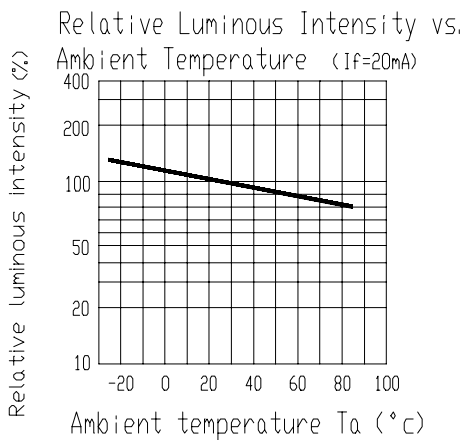
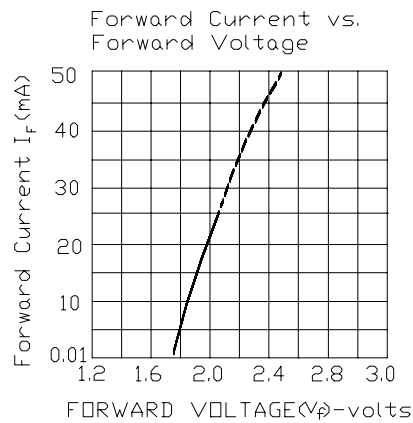
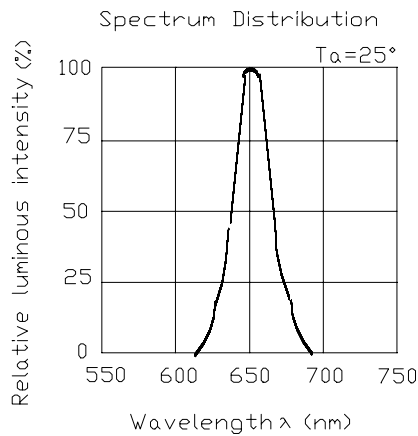



EVERLIGHT ELECTRONICS CO.,LTD.

Device Number : DLE-038-159

REV: 1.0

T-1 3/4 (5mm) Round Shape LEDs

MODEL NO 383-2SDRC/S530-A5

ECN :

Page: 4/4

■ Reliability test items and conditions

| NO | Item | Test Conditions | Test Hours/Cycle | Sample Size | Ac/Re |
|----|----------------------------------|---|------------------|-------------|-------|
| 1 | Soldering Heat | TEMP : 260°C ± 5 °C | 5 SEC | 76 Pcs | 0/1 |
| 2 | Temperature Cycle | H : +85°C 30min ∫ 5 min L : -55°C 30min | 50 CYCLE | 76 Pcs | 0/1 |
| 3 | Thermal Shock | H : +100°C 5min ∫ 10 sec L : -10°C 5min | 50 CYCLE | 76 Pcs | 0/1 |
| 4 | High Temperature Storage | TEMP : 100°C | 1000 HRS | 76 Pcs | 0/1 |
| 5 | Low Temperature Storage | TEMP : -55°C | 1000 HRS | 76 Pcs | 0/1 |
| 6 | DC Operating Life | If = 20 mA | 1000 HRS | 76 Pcs | 0/1 |
| 7 | High Temperature / High Humidity | 85°C/85% RH | 1000 HRS | 76 Pcs | 0/1 |