

Typical Applications

- GSM/DCS Dual-Band Handsets
- Cellular/PCS Dual-Band Handsets
- General Purpose Amplification
- Commercial and Consumer Systems

Product Description

The RF2363 is a dual-band Low Noise Amplifier designed for use as a front-end for 950MHz GSM/1850MHz DCS applications and may be used for dual-band cellular/PCS applications. The 900MHz LNA is a single-stage amplifier; the 1900MHz LNA is a 2-stage amplifier. The part may also be tuned for applications in other frequency bands. The device has an excellent combination of low noise figure and high linearity at a very low supply current. It is packaged in a very small industry standard SOT 8-lead plastic package.

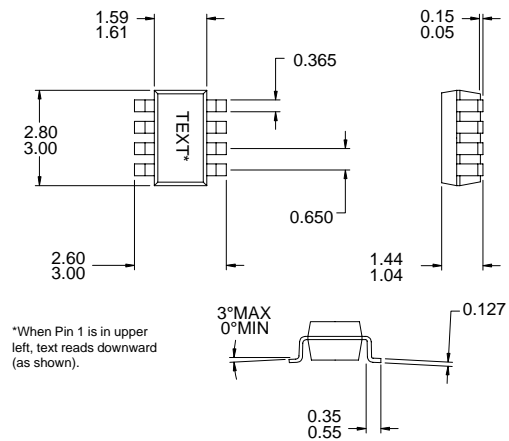

4
GENERAL PURPOSE AMPLIFIERS

Optimum Technology Matching® Applied

- | | | |
|-------------------------------------|--|--------------------------------------|
| <input type="checkbox"/> Si BJT | <input checked="" type="checkbox"/> GaAs HBT | <input type="checkbox"/> GaAs MESFET |
| <input type="checkbox"/> Si Bi-CMOS | <input type="checkbox"/> SiGe HBT | <input type="checkbox"/> Si CMOS |

Package Style: SOT, 8-Lead

- Features
- Low Noise and High Intercept Point
 - 18dB Gain at 900MHz
 - 21dB Gain at 1900MHz
 - Low Supply Current
 - Single 2.5V to 5.0V Power Supply
 - Very Small SOT-23-8 Plastic Package

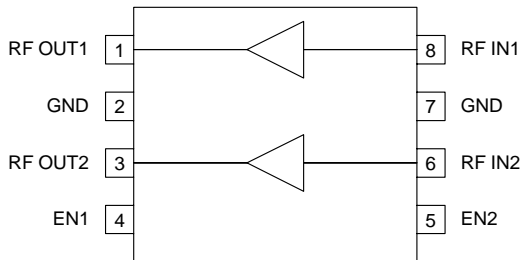

Functional Block Diagram

Ordering Information

RF2363	Dual-Band 3V Low Noise Amplifier
RF2363 PCBA	Fully Assembled Evaluation Board

RF Micro Devices, Inc.
7625 Thorndike Road
Greensboro, NC 27409, USA

Tel (336) 664 1233
Fax (336) 664 0454
<http://www.rfmd.com>

Absolute Maximum Ratings

Parameter	Rating	Unit
Supply Voltage	-0.5 to +6.0	V _{DC}
Input RF Level	+10	dBm
Operating Ambient Temperature	-40 to +85	°C
Storage Temperature	-40 to +150	°C



Caution! ESD sensitive device.

RF Micro Devices believes the furnished information is correct and accurate at the time of this printing. However, RF Micro Devices reserves the right to make changes to its products without notice. RF Micro Devices does not assume responsibility for the use of the described product(s).

4

GENERAL PURPOSE
AMPLIFIERS

Parameter	Specification			Unit	Condition
	Min.	Typ.	Max.		
Overall RF Frequency Range		800 to 1000 1800 to 2000		MHz MHz	
950MHz Performance					T = 25°C, RF=950MHz, V _{CC} =2.8V, EN1=2.8V, EN2=0V
Gain	16	18	20	dB	EN1=0V Gain - Isolation No external matching With external match as per GSM/DCS Appli- cation Schematic
Isolation		16		dB	
Gain Step		34		dB	
Noise Figure		1.3		dB	
Output IP3	+17	+24		dBm	
Input P1dB		-10		dBm	
Reverse Isolation		20		dB	
Input VSWR		1.8:1	2:1		
Output VSWR		1.8:1	2:1		
1850MHz Performance					T = 25°C, RF=1850MHz, V _{CC} =2.8V, EN2=2.8V, EN1=0V
Gain	20	21.5	24	dB	EN2=0V Gain - Isolation No external matching With external match as per GSM/DCS Appli- cation Schematic
Isolation		10		dB	
Gain Step		31.5		dB	
Noise Figure		1.4		dB	
Output IP3	+16	+22		dBm	
Input P1dB		-12		dBm	
Reverse Isolation		30		dB	
Input VSWR		1.7:1	2:1		
Output VSWR		1.7:1	2:1		
LNA Select					
"Enable" Voltage		V _{CC}		V	
"Disable" Voltage		0		V	
Power Supply					T = 25 °C
Voltage		2.8 2.5 to 5.0		V V	Specifications Operating limits
Current Consumption		5		mA	900MHz LNA Enabled, 1900MHz LNA Dis- abled; total DC current
		7.5		mA	1900MHz LNA Enabled, 900MHz LNA Dis- abled; total DC current
			1	µA	EN1=EN2=0V

Pin	Function	Description	Interface Schematic
1	RF OUT1	RF output pin for ~900MHz LNA. This pin is an open-collector output. It must be biased to either V_{CC} or pin 4 through a choke or matching inductor. It is typically matched to 50Ω with a shunt bias/matching inductor and series blocking/matching capacitor. Refer to application schematics.	
2	GND	Ground connection. NOTE: Ground traces on pins 2 and 7 are equivalent to a small amount of inductance (~0.75nH). The dimensions of these lines are as follows. Pin 2: L=56mils, W=15mils, H=31mils Pin 7: L=56mils, W=15mils, H=31mils Dielectric is FR-4.	
3	RF OUT2	RF output pin for ~1900MHz LNA. This pin is an open-collector output. It must be biased to either V_{CC} or pin 4 through a choke or matching inductor. It is typically matched to 50Ω with a shunt bias/matching inductor and series blocking/matching capacitor. Refer to application schematics.	
4	EN1	Enable pin for ~900MHz LNA. A voltage equal to the supply voltage LNA. This pin should be disabled (0V) when the ~1900MHz LNA is in use.	
5	EN2	Enable pin for ~1900MHz LNA. A voltage equal to the supply voltage LNA. This pin should be disabled (0V) when the ~900MHz LNA is in use. See package drawing for description of pin orientation.	See pin 3.
6	RF IN2	RF input pin for ~1900MHz. This pin is matched to approximately 50Ω at DCS/PCS frequencies. An external AC coupling capacitor is required at this pin.	See pin 3.
7	GND	Same as pin 2.	See pin 2.
8	RF IN1	RF input pin for ~900MHz. This pin is matched to approximately 50Ω at GSM/Cellular frequencies. An external AC coupling capacitor is required at this pin.	See pin 1.

RF2363 Theory of Operation and Application Information

The RF2363 contains two independent low noise amplifiers which have been optimized for dual-band applications in the GSM (905MHz to 960MHz) and DCS (1805MHz to 1880MHz) frequency bands. Fabricated using heterojunction bipolar transistor (HBT) technology, the RF2363 delivers high linear gain at a very low noise figure and low power consumption. Internal temperature compensation keeps the gain tightly controlled over temperature extremes (typically less than 1dB of gain variation from -40°C to +85°C at 2.8V). A 50Ω input impedance allows the part to be connected to standard receiver front end filters without additional matching components.

MODE CONTROL

The RF2363 incorporates two enable pins (EN1 and EN2) for biasing the desired LNA according to the table below.

EN1	EN2	Mode
GND	GND	Power Down
GND	VCC	1900MHz LNA On
VCC	GND	900MHz LNA On

900MHz LNA

The 900MHz LNA is a single-stage, common emitter amplifier. Since the input pin contains a DC bias, an AC coupling capacitor is required at this pin. An external bias inductor from the output pin (RF OUT1) to VCC provides DC biasing for the amplifier transistor and assists in matching the output impedance to the next receiver stage. A capacitor having a good RF bypass characteristic at the frequency of operation should be placed as close as possible to the supply voltage side of the bias inductor; a low frequency bypass capacitor should also be included. The EN1 pin supplies VCC to the bias circuits of the LNA and should also be effectively bypassed with both low and high frequency capacitors.

1900MHz LNA

The 1900MHz LNA is implemented by two common emitter stages in cascade. The first stage is biased through an external inductor at the EN2 pin. This inductor also acts as an interstage match; a resistor in parallel with the inductor is recommended to 'de-Q' the inductor, thus providing a broader band interstage match. An external bias inductor from the output pin (RF OUT2) to VCC provides DC biasing for the second stage transistor and assists in matching the output impedance to the next receiver stage. Low and high frequency bypass capacitors should be used on the supply side of both the EN2 and RF OUT2 bias inductors. An AC coupling capacitor is required at the RF IN2 pin.

LAYOUT CONSIDERATIONS

To provide optimal balance of gain and linearity, a small amount of inductance is required in the ground traces of the PCB. The recommended inductance is between 0.5 and 1.0nH, with 0.75nH used on the Evaluation Board. Depending on the application, more gain with less linearity or more linearity with less gain may be desired. Appropriate adjustment of the ground inductance can accomplish these objectives. Minimizing the ground inductance will maximize the gain at the expense of linearity while increasing the ground inductance will increase the linearity at the expense of gain. It is important to remember that the pin 7 ground inductance affects the performance of both LNAs, while the pin 2 ground inductance affects only the 1900MHz LNA.

Application Schematic (GSM/DCS)

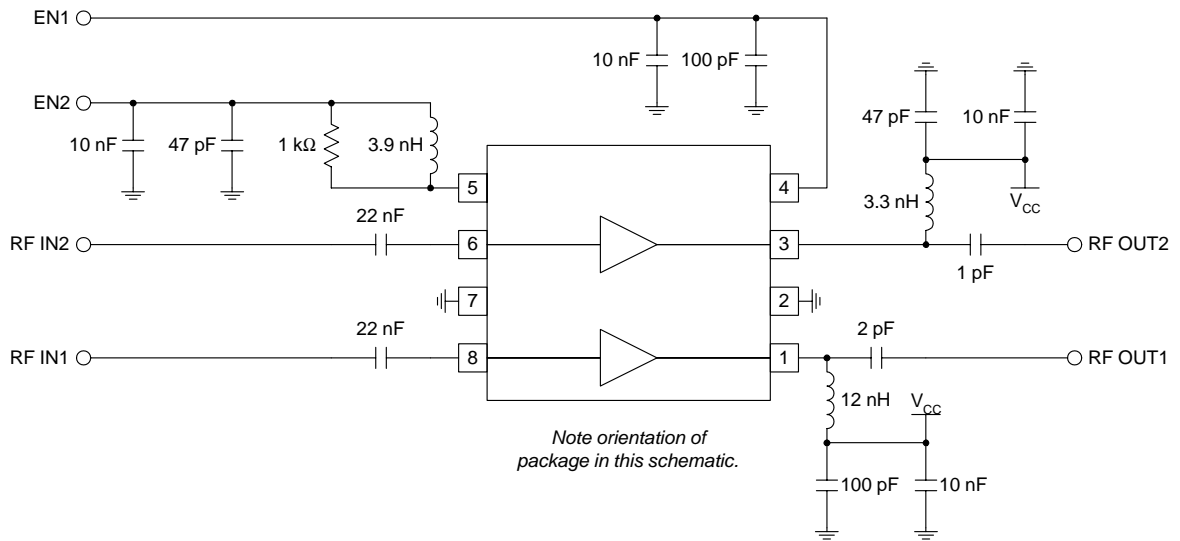

Evaluation Board Schematic
(Download [Bill of Materials](http://www.rfmd.com) from www.rfmd.com.)

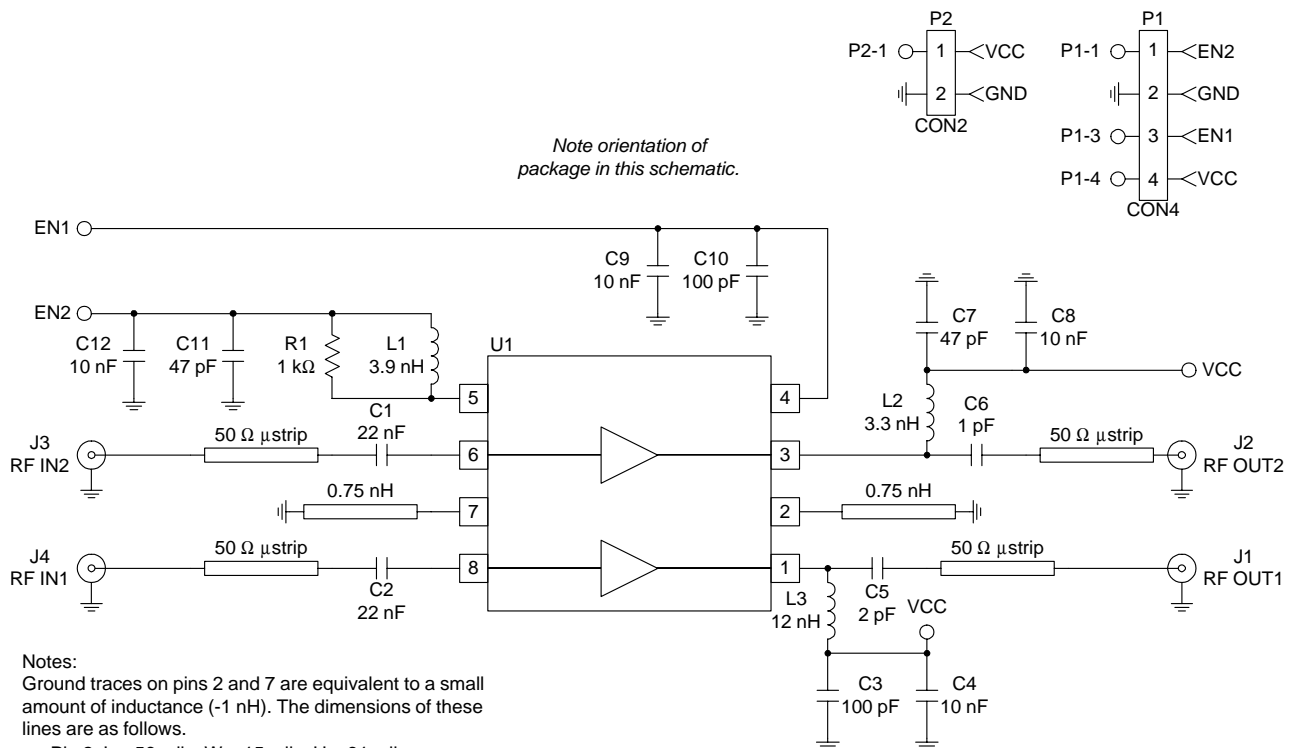

Notes:
Ground traces on pins 2 and 7 are equivalent to a small amount of inductance (-1 nH). The dimensions of these lines are as follows.

- Pin 2: L = 56 mils, W = 15 mils, H = 31 mils
- Pin 7: L = 56 mils, W = 15 mils, H = 31 mils
- Dielectric is FR-4

Evaluation Board Layout
Board Size 1.0" x 1.0"
Board Thickness 0.031", Board Material FR-4

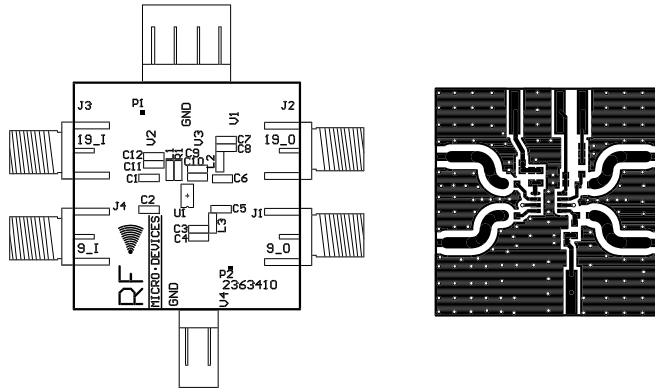

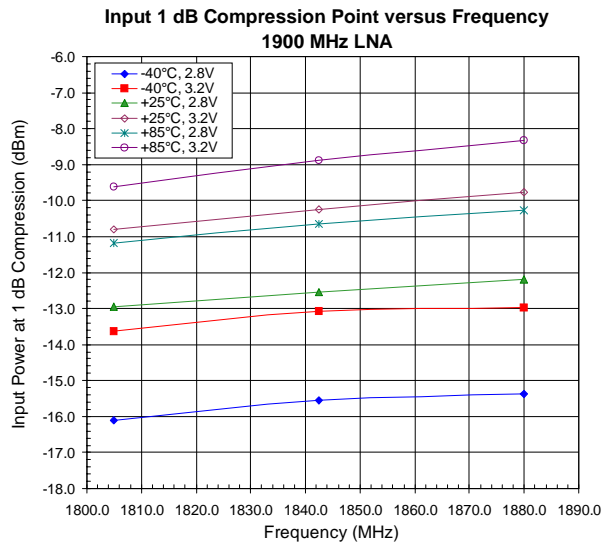
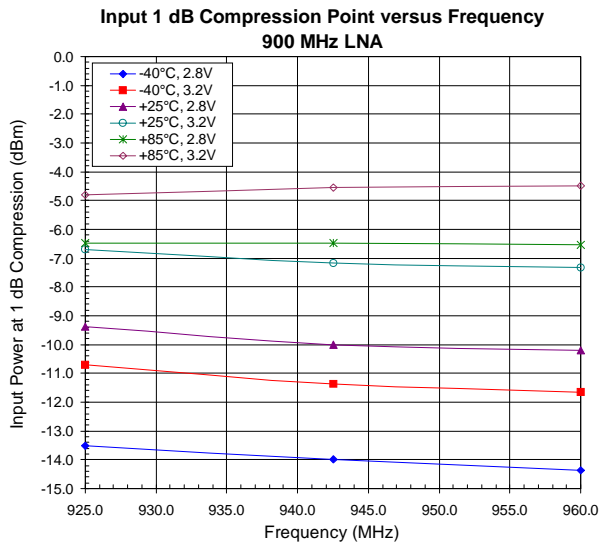
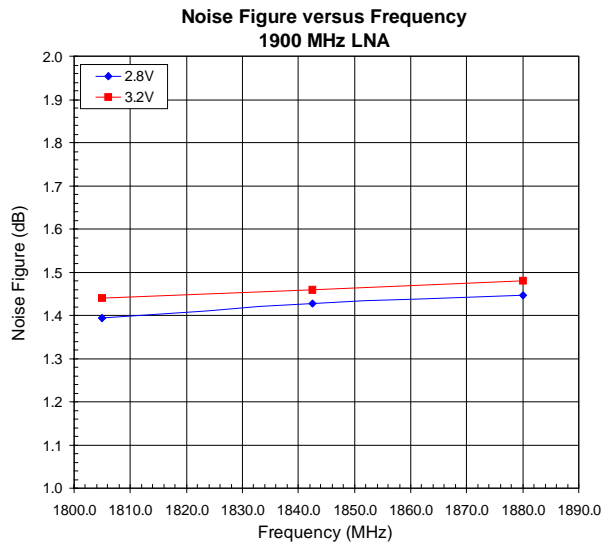
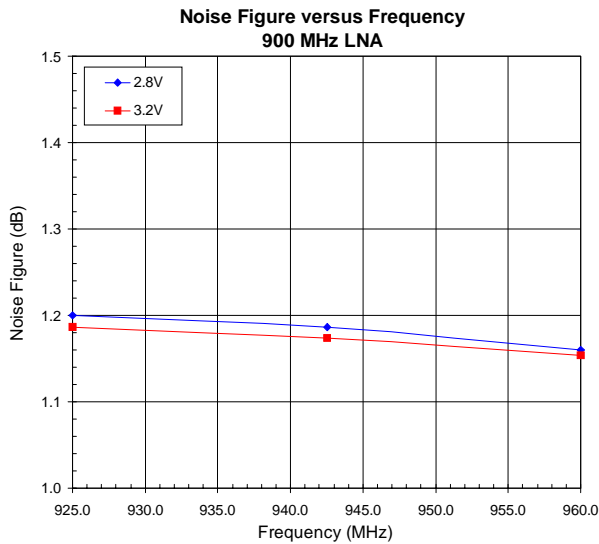
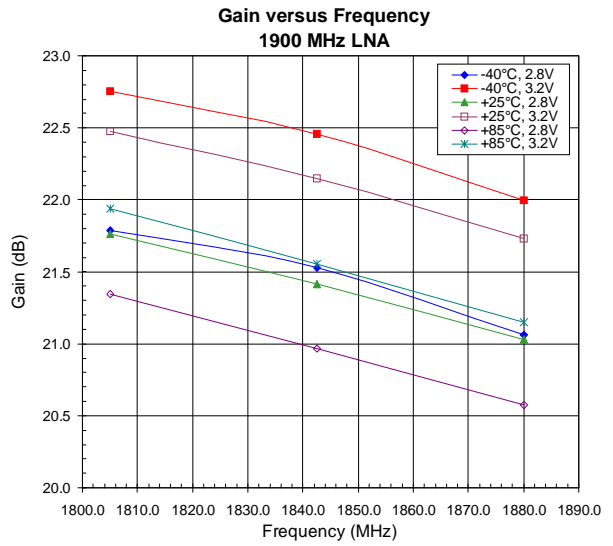
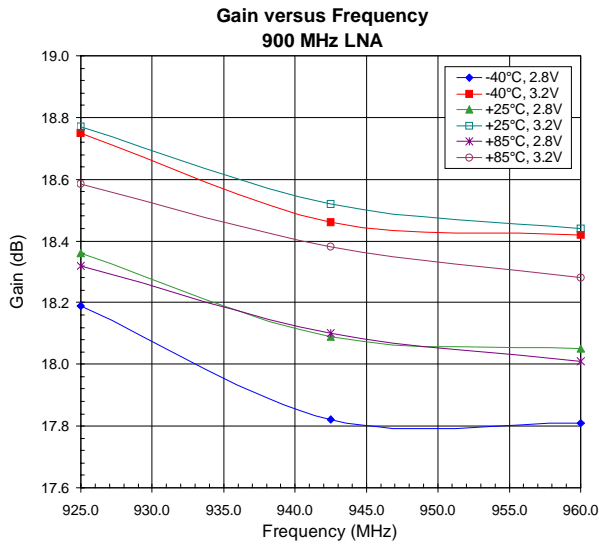

Output 3rd Order Intercept Point versus Frequency
900 MHz LNA

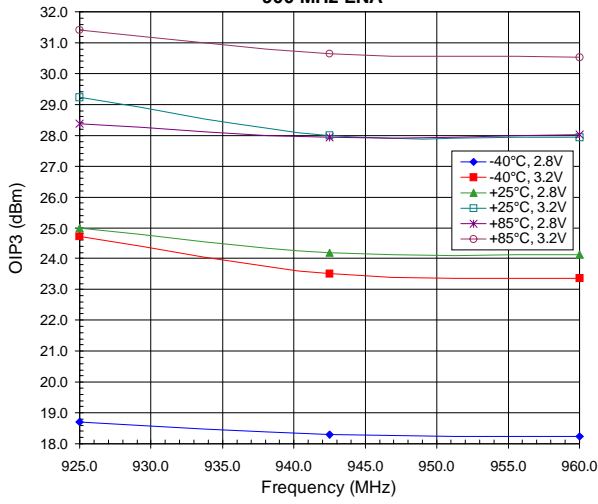

Output 3rd Order Intercept Point versus Frequency
1900 MHz LNA

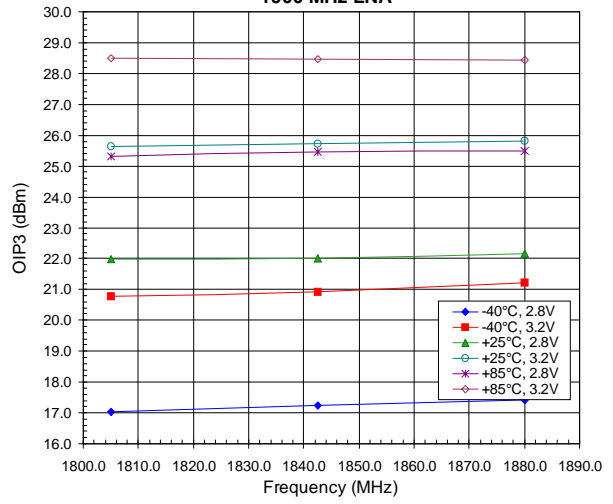

Current versus Supply Voltage
900 MHz LNA

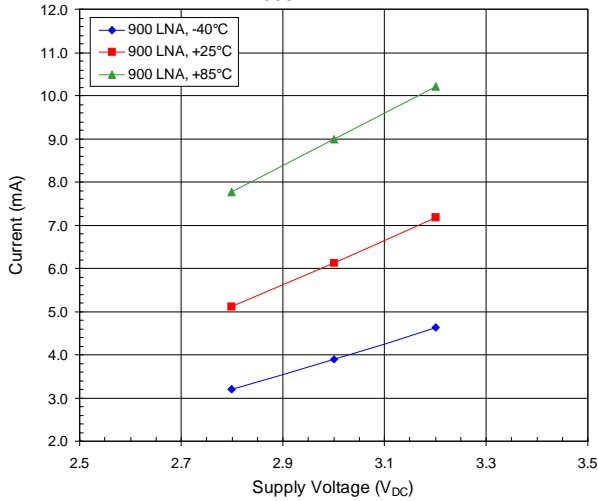

Current versus Supply Voltage
1900 MHz LNA

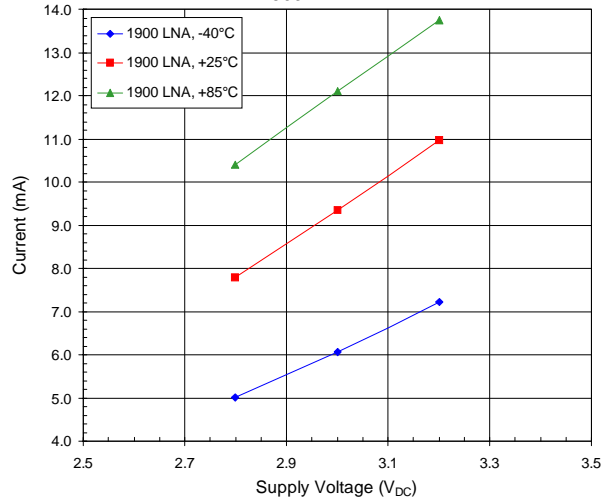

900MHz LNA

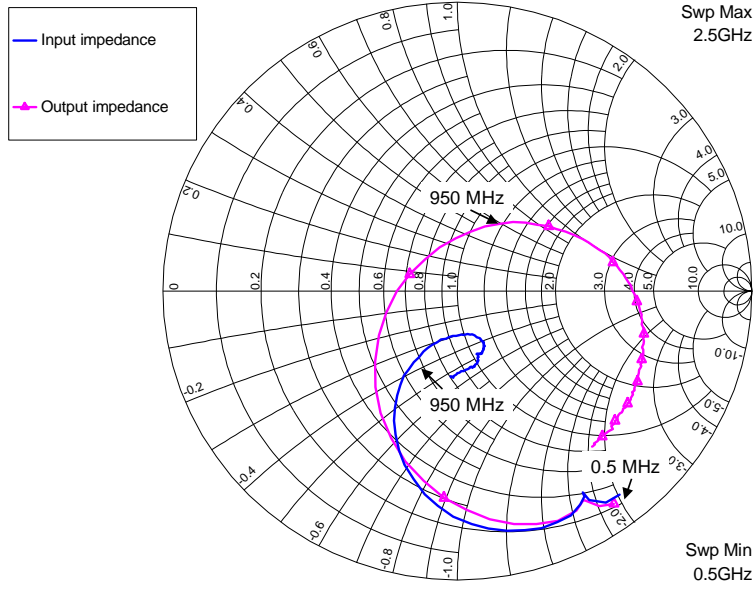

1900MHz LNA

