

PACKAGE DIMENSIONS

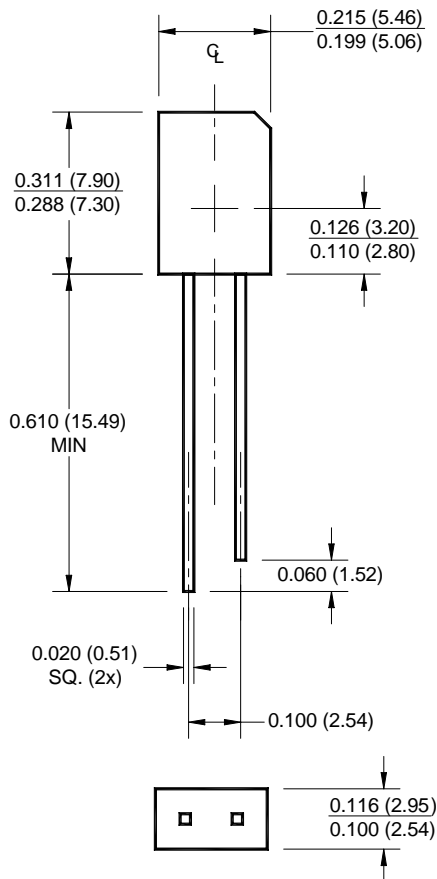

NOTES:

1. Dimensions for all drawings are in inches (mm).
2. Tolerance of $\pm .010 (.25)$ on all non-nominal dimensions unless otherwise specified.

FEATURES

- Daylight Filter
- Sidelooker Package
- Pin Photodiode
- Wide Reception Angle, 120°
- Chip Size = .107² inches (2.71² mm)

SCHEMATIC

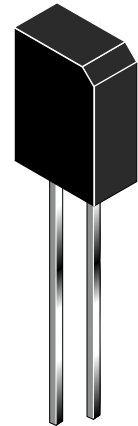
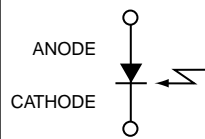

1. Derate power dissipation linearly 2.50 mW/°C above 25°C.
2. RMA flux is recommended.
3. Methanol or isopropyl alcohols are recommended as cleaning agents.
4. Soldering iron 1/16" (1.6mm) minimum from housing.
5. As long as leads are not under any stress or spring tension.
6. Light source is an GaAs LED which has a peak emission wavelength of 940 nm.
7. All measurements made under pulse conditions.

ABSOLUTE MAXIMUM RATINGS (T_A = 25°C unless otherwise specified)

Parameter	Symbol	Rating	Unit
Operating Temperature	T _{OPR}	-40 to +85	°C
Storage Temperature	T _{STG}	-40 to +85	°C
Soldering Temperature (Iron)(2,3,4)	T _{SOL-I}	240 for 5 sec	°C
Soldering Temperature (Flow)(2,3)	T _{SOL-F}	260 for 10 sec	°C
Reverse Voltage	V _R	32	V
Power Dissipation(1)	P _D	150	mW

ELECTRICAL / OPTICAL CHARACTERISTICS ($T_A = 25^\circ\text{C}$ unless otherwise specified)						
PARAMETER	TEST CONDITIONS	SYMBOL	MIN	TYP	MAX	UNITS
Reverse Voltage	$I_R = 0.1 \text{ mA}$	V_R	32		—	V
Dark Reverse Current	$V_R = 10 \text{ V}$	$I_{R(D)}$	—		30	nA
Peak Sensitivity	$V_R = 5 \text{ V}$	λ_{PK}		920		nm
Reception Angle @ 1/2 Power		Θ		+/-60		Degrees
Photo Current	$E_e = 1.0 \text{ mW/cm}^2$, $V_{CE} = 5 \text{ V}^{(6)}$	I_{PH}	30		—	μA
Capacitance	$V_R = 3 \text{ V}$	C		20		pF
Rise Time	$V_R = 5 \text{ V}$, $R_L = 1 \text{ K}$	t_r		50		ns
Fall Time	$V_R = 5 \text{ V}$, $R_L = 1 \text{ K}$	t_f		50		ns

TYPICAL PERFORMANCE CURVES

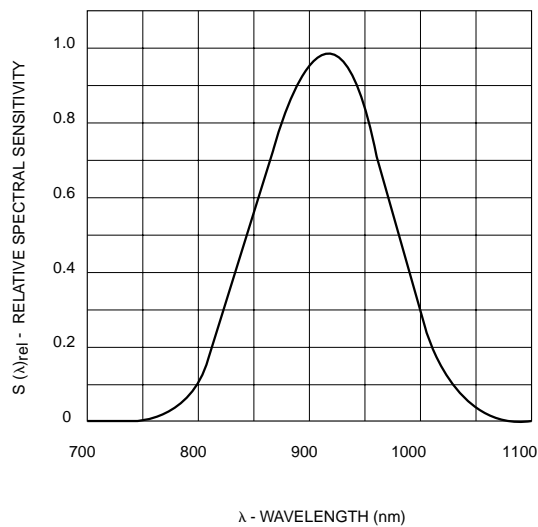

Fig. 1 Relative Spectral Sensitivity vs. Wavelength

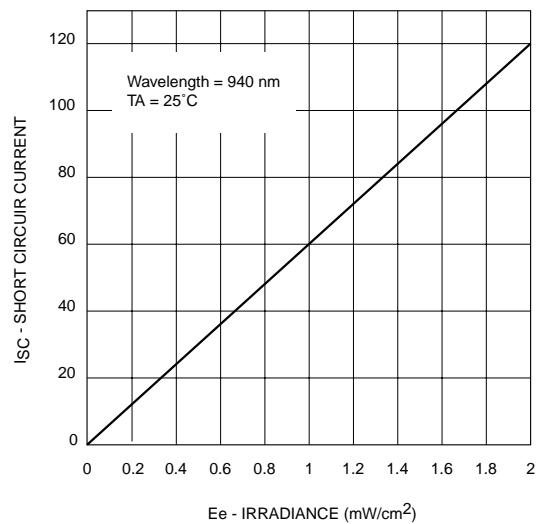

Fig. 2 Short Circuit Current vs. Irradiance

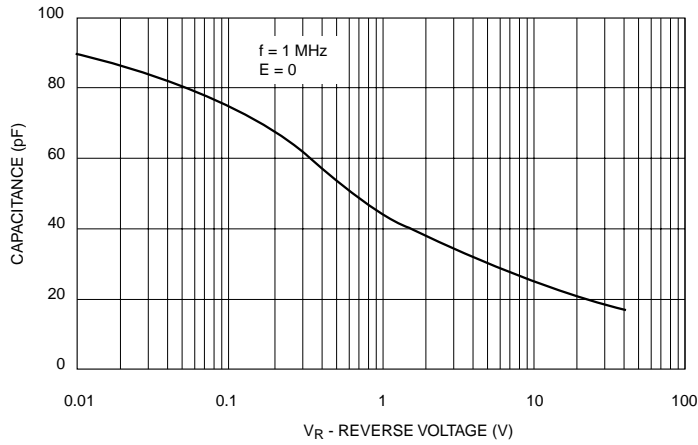

Fig. 3 Capacitance vs. Reverse Voltage

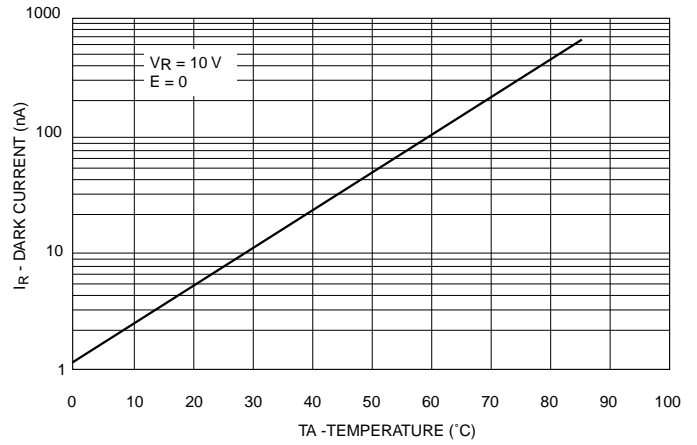

Fig. 4 Dark Current vs. Temperature

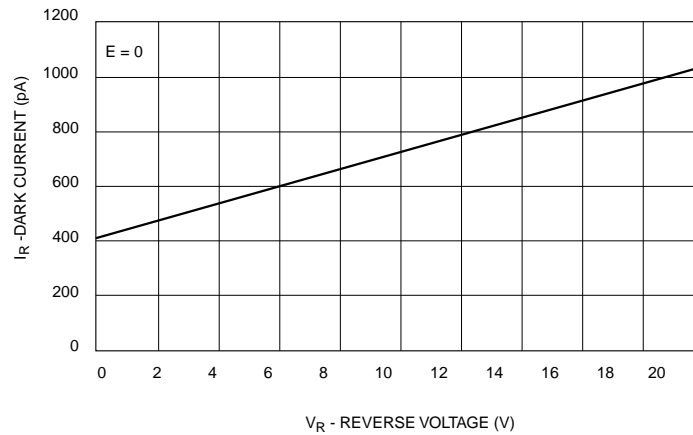

Fig. 5 Dark Current vs. Reverse Voltage