

HIGH ISOLATION VOLTAGE AC INPUT RESPONSE TYPE SOP MULTI PHOTOCOUPLER

PS2705-1

FEATURES

- **HIGH ISOLATION VOLTAGE**
BV: 3.75 k V_{r.m.s.} MIN
- **SOP (SMALL OUT-LINE PACKAGE)**
- **ISOLATED CHANNELS PER EACH PACKAGE**
- **AC INPUT RESPONSE**
- **HIGH SPEED SWITCHING**
 $t_r = 3 \mu s$, $t_f = 5 \mu s$ TYP
- **LOW COLLECTOR TO EMITTER DARK CURRENT**
 $I_{CEO} = 5 \text{ nA}$ TYP @ $T_A = 25^\circ C$, $V_{CE} = 40 \text{ V}$
- **HIGH CURRENT TRANSFER RATIO**
CTR = 100% TYP
- **TAPE AND REEL AVAILABLE**

DESCRIPTION

PS2705-1 is an optically coupled isolator containing a GaAs light emitting diode and an NPN silicon phototransistor. The device is mounted in a plastic SOP (Small Out-line Package) for high density applications and has a shield effect to cut off ambient light.

APPLICATIONS

Interface circuit for various instrumentations and control equipment.

- **AC LINE/DIGITAL LOGIC**
- **DIGITAL LOGIC INTERFACE**
- **TWISTED PAIR LINE RECEIVER**
- **TELEPHONE/TELEGRAPH LINE RECEIVER**
- **SEQUENCE CONTROLLERS**
- **SYSTEMS APPLICATIONS, MEASURING INSTRUMENTS**

ELECTRICAL CHARACTERISTICS ($T_A = 25^\circ C$)

PART NUMBER			PS2705-1			
SYMBOLS	PARAMETERS	UNITS	MIN	TYP	MAX	
Diode	V_F	Forward Voltage, $I_F = \pm 5 \text{ mA}$	V	1.1	1.4	
	C_t	Terminal Capacitance, $V = 0$, $f = 1.0 \text{ MHz}$	pF	60		
Transistor	I_{CEO}	Collector to Emitter Dark Current, $V_{CE} = 40 \text{ V}$, $I_F = 0$	nA		100	
Coupled	CTR	Current Transfer Ratio ¹ , $I_F = \pm 5 \text{ mA}$, $V_{CE} = 5 \text{ V}$	%	50	100	300
	CTR ₁ /CTR ₂	CTR Ratio ³ , $I_F = \pm 5 \text{ mA}$, $V_{CE} = 5 \text{ V}$		0.3	1.0	3.0
	$V_{CE(sat)}$	Collector Saturation Voltage, $I_F = \pm 10 \text{ mA}$, $I_C = 2 \text{ mA}$	V			0.3
	R _{I-O}	Isolation Resistance, $V_{in-out} = 1.0 \text{ k VDC}$	Ω	10^{11}		
	C _{I-O}	Isolation Capacitance, $V = 0$, $f = 1.0 \text{ MHz}$	pF		0.4	
	t_r	Rise Time ² , $V_{CC} = 5 \text{ V}$, $I_C = 2 \text{ mA}$, $R_L = 100 \Omega$	μs		3	
	t_f	Fall Time ² , $V_{CC} = 5 \text{ V}$, $I_C = 2 \text{ mA}$, $R_L = 100 \Omega$	μs		5	

Notes:

1. CTR Rank

- M: 50 - 150%
- L: 100 - 300%
- N: 50 - 300%

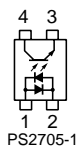

2. Test Circuit for Switching Time

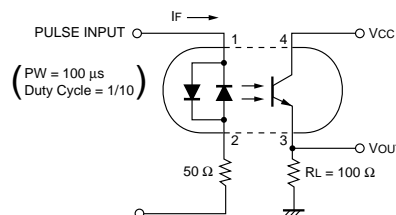

3. $CTR_1 = I_{C1}/I_{F1}$, $CTR_2 = I_{C2}/I_{F2}$

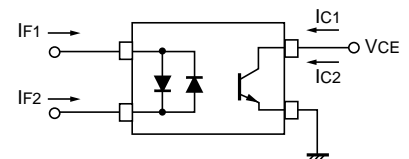

ABSOLUTE MAXIMUM RATINGS¹ (T_A = 25°C)

SYMBOLS	PARAMETERS	UNITS	RATINGS
			PS2705-1
Diode			
I _F	Forward Current (DC)	mA	±50
P _D	Power Dissipation	mW/Ch	80
ΔP _D /°C	Power Dissipation Derating	mW/°C	0.8
I _F (PEAK)	Peak Forward Current (PW = 100 μs, Duty Cycle 1%)	A	±1
Transistor			
V _{CEO}	Collector to Emitter Voltage (I _c = 1mA, I _B = 0)	V	40
V _{ECO}	Emitter to Collector Voltage (I _E = 100μA, I _B = 0)	V	6
I _c	Collector Current	mA/Ch	80
P _c	Power Dissipation	mW/Ch	150
ΔP _c /°C	Power Dissipation Derating	mW/°C	1.5
Coupled			
BV	Isolation Voltage ²	V _{r.m.s.}	3750
T _{STG}	Storage Temperature	°C	-55 to +150
T _A	Ambient Temperature	°C	-55 to +100

Notes:

1. Operation in excess of any one of these parameters may result in permanent damage.
2. AC voltage for 1 minute at T_A = 25 °C, RH = 60 % between input and output.

TYPICAL PERFORMANCE CURVES (T_A = 25°C)

DIODE POWER DISSIPATION vs. AMBIENT TEMPERATURE

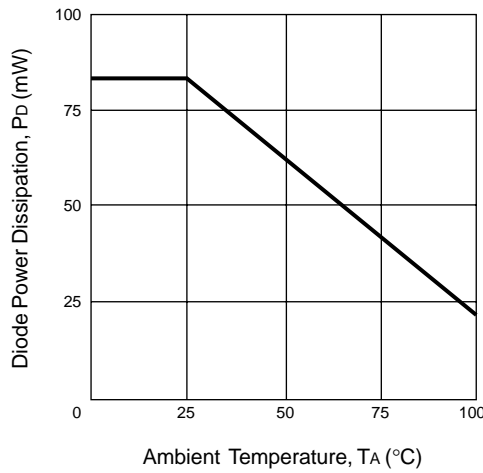

TRANSISTOR POWER DISSIPATION vs. AMBIENT TEMPERATURE

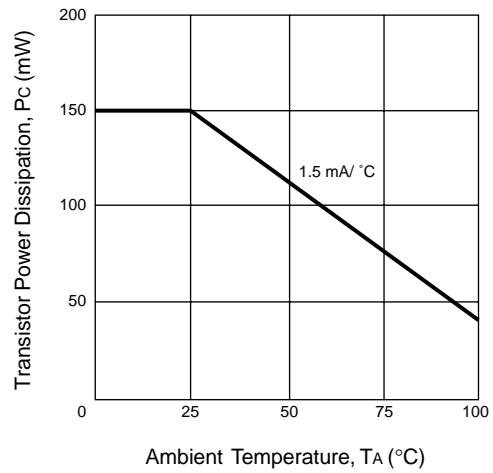

FORWARD CURRENT vs. FORWARD VOLTAGE

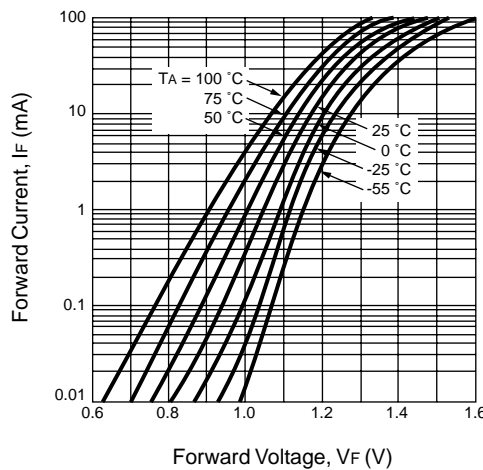

FORWARD CURRENT vs. FORWARD VOLTAGE

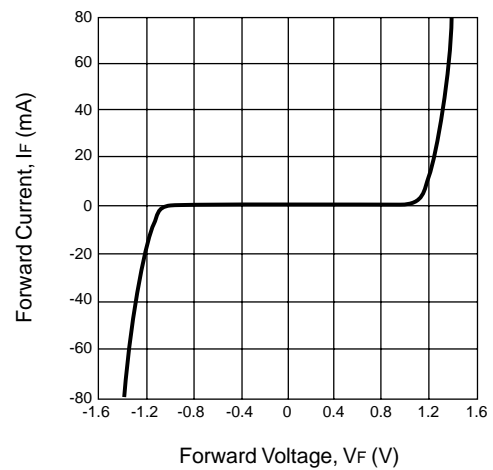

TYPICAL PERFORMANCE CURVES ($T_A = 25^\circ\text{C}$)

COLLECTOR TO EMITTER DARK CURRENT vs. AMBIENT TEMPERATURE

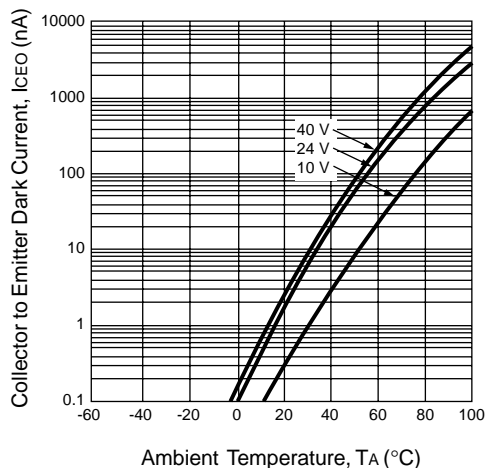

COLLECTOR CURRENT vs. COLLECTOR SATURATION VOLTAGE

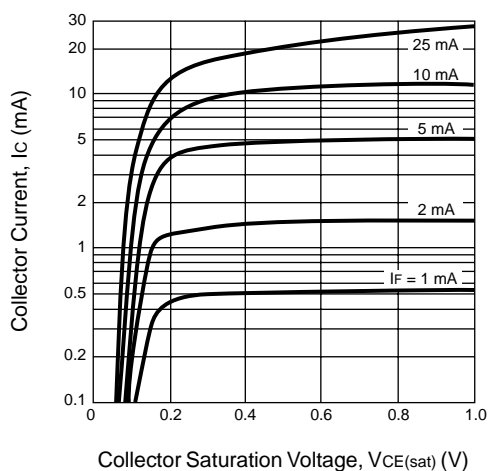

COLLECTOR CURRENT vs. COLLECTOR TO EMITTER VOLTAGE

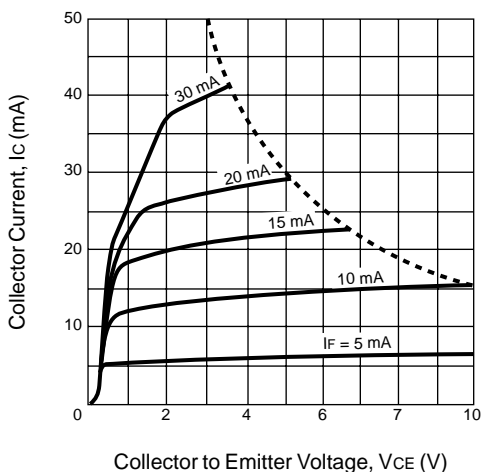

NORMALIZED OUTPUT CURRENT vs. AMBIENT TEMPERATURE

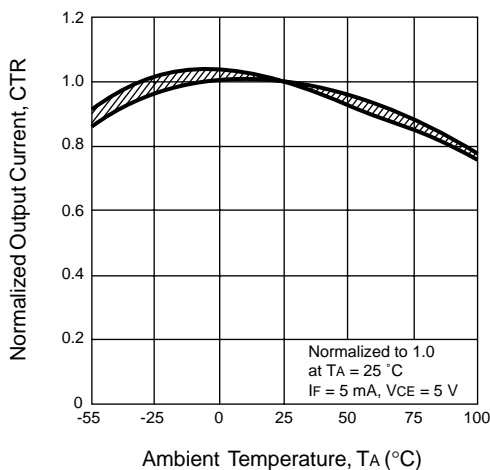

CURRENT TRANSFER RATIO vs. FORWARD CURRENT

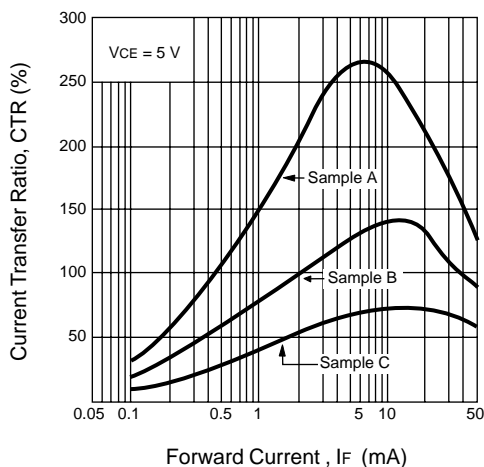

SWITCHING TIME vs. LOAD RESISTANCE

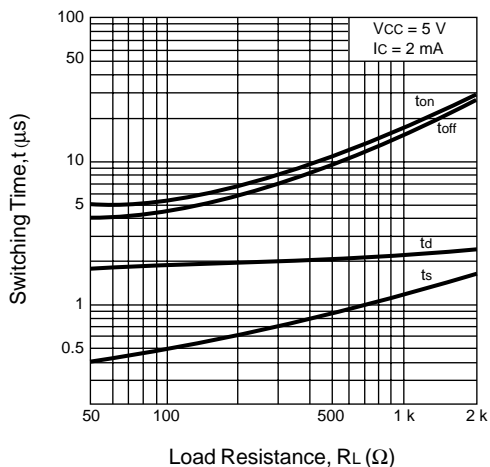

TYPICAL PERFORMANCE CURVES ($T_A = 25^\circ\text{C}$)

SWITCHING TIME vs. LOAD RESISTANCE

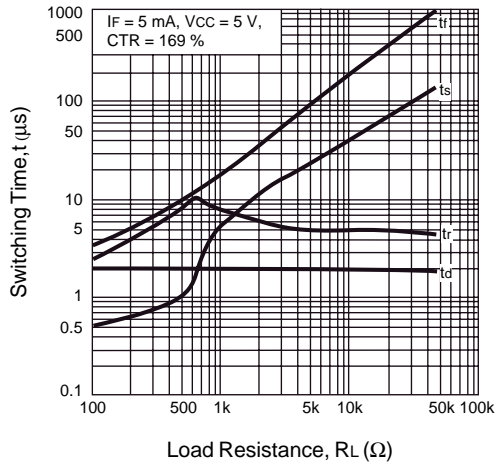

FREQUENCY RESPONSE

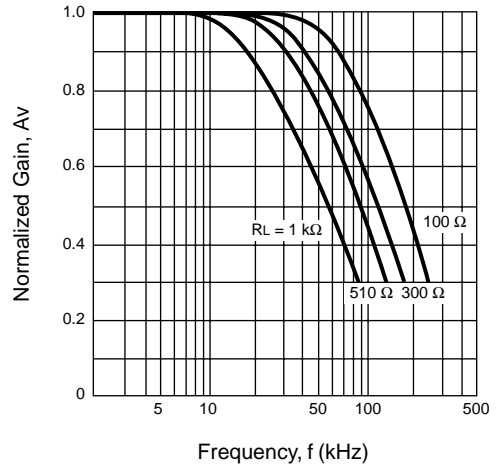

CTR DEGRADATION

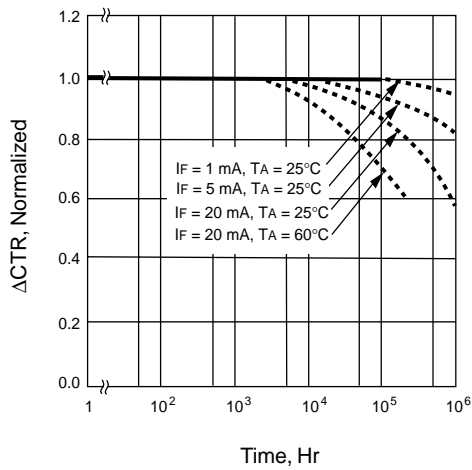

OUTLINE DIMENSIONS (Units in mm)

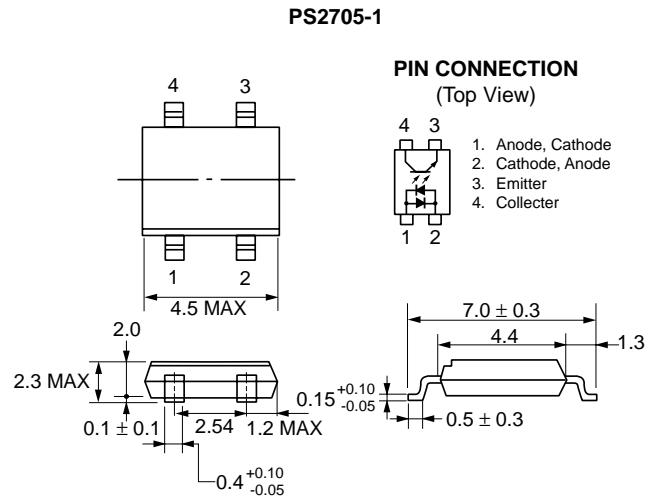

TAPING SPECIFICATIONS (Units in mm)

OUTLINE AND DIMENSIONS (TAPE)

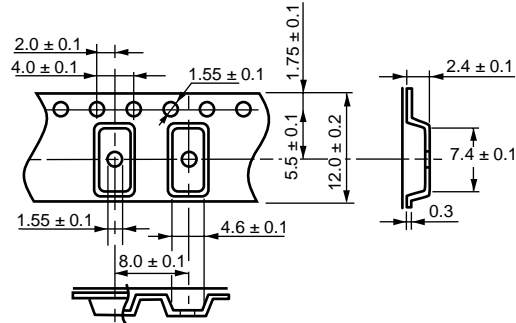

TAPING DIRECTION

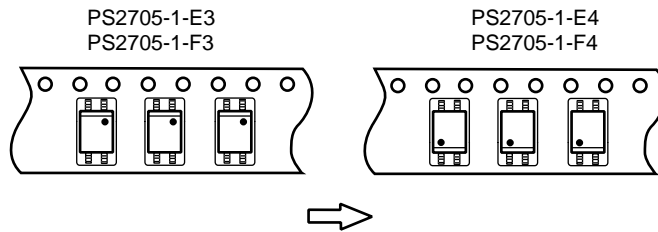

OUTLINE AND DIMENSIONS (REEL)

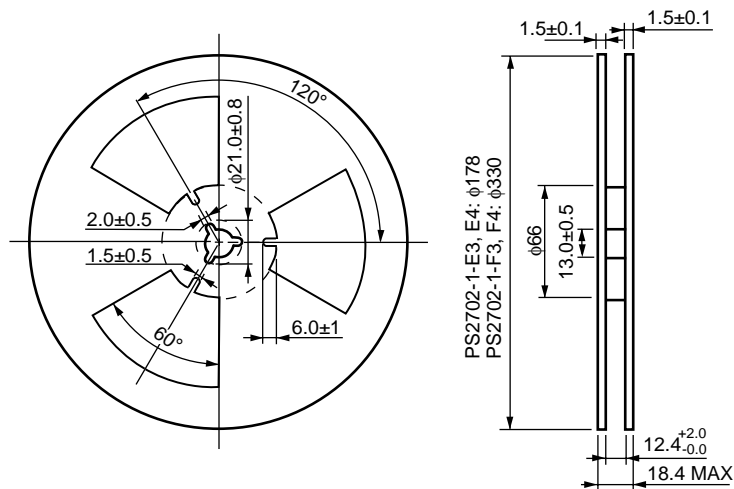

Packing: PS2705-1-E3, E4 900 pcs/reel
 PS2705-1-F3, F4 3500 pcs/reel

RECOMMENDED SOLDERING CONDITIONS

(1) Infrared reflow soldering

- **Peak reflow temperature** 235 °C (package surface temperature)
- **Time of temperature higher than 210 °C** 30 seconds or less
- **Number of reflows** Three
- **Flux** Rosin flux containing small amount of chlorine (The flux with a maximum chlorine content of 0.2 Wt % is recommended).

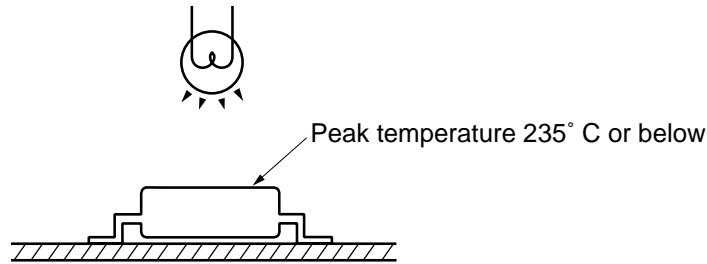
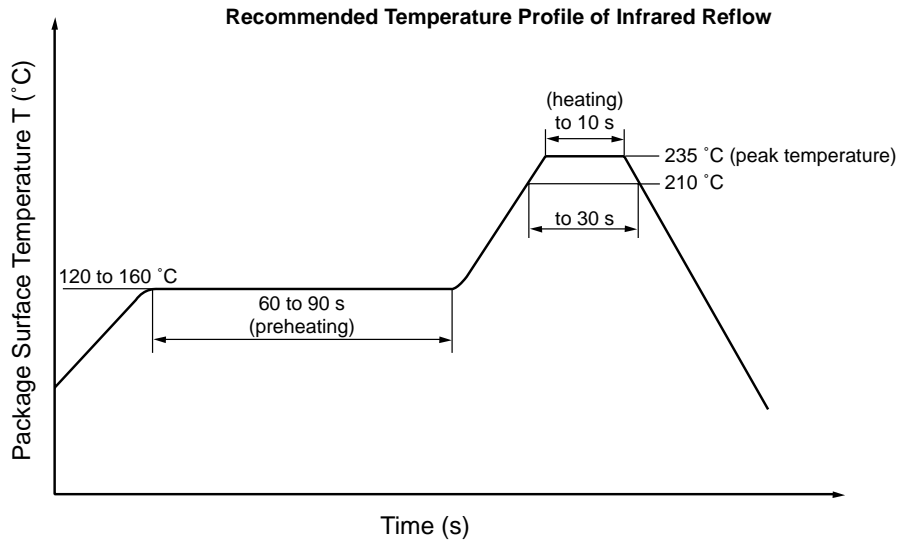

(2) Dip soldering

- **Temperature** 260 °C or below (molten solder temperature)
- **Time** 10 seconds or less
- **Number of times** One
- **Flux** Rosin flux containing small amount of chlorine (The flux with a maximum chlorine content of 0.2 Wt % is recommended).

CAUTION

This device contains GaAs (Gallium Arsenide) material which is a harmful substance if ingested.
Please do not under any circumstances break the hermetic seal.