

## PQ1CYxx3LZPH Series

To-263 Surface Mount Type  
Chopper Regulator

### ■ Features

1. Maximum switching current: 3.5A
2. Built-in ON/OFF control function
3. High frequency oscillation  
(Oscillation frequency: 150kHz)
4. Built-in overheat protection function, overcurrent shut-down function
5. Fixed output voltage type  
(Output voltage is 3.3V/5.0V)
6. RoHS directive compliant

### ■ Applications

1. Digital AV equipment
2. OA equipment
3. CRT monitor/LCD monitor

### ■ Model Line-up

Output Voltage	Model No.
3.3V	<b>PQ1CY333LZPH</b>
5.0V	<b>PQ1CY503LZPH</b>

### ■ Absolute Maximum Ratings

(Ta=25°C)

Parameter	Symbol	Rating	Unit
*1 Input voltage	V <sub>IN</sub>	40	V
FB pin voltage	V <sub>FB</sub>	8	V
Input-output voltage	V <sub>I-O</sub>	41	V
*2 Output-GND voltage	V <sub>OUT</sub>	-1	V
*3 ON/OFF pin voltage	V <sub>C</sub>	-0.3 to 40	V
Switching current	I <sub>SW</sub>	3.5	A
*4 Power dissipation	P <sub>D</sub>	35	W
*5 Junction temperature	T <sub>j</sub>	150	°C
Operating temperature	T <sub>opr</sub>	-20 to +85	°C
Storage temperature	T <sub>stg</sub>	-40 to +150	°C
Soldering temperature	T <sub>sol</sub>	260(10s)	°C

\*1 Voltage between V<sub>IN</sub> terminal and GND terminal.

\*2 Voltage between V<sub>OUT</sub> terminal and GND terminal.

\*3 Voltage between ON/OFF terminal and GND terminal.

\*4 P<sub>D</sub>: With infinite heat sink

\*5 There is case that over heat protection function operates at the temperature T<sub>j</sub>=125°C to 150°C, so this item cannot be used in this temperature range.

### ■ Outline Dimensions

(Unit:mm)

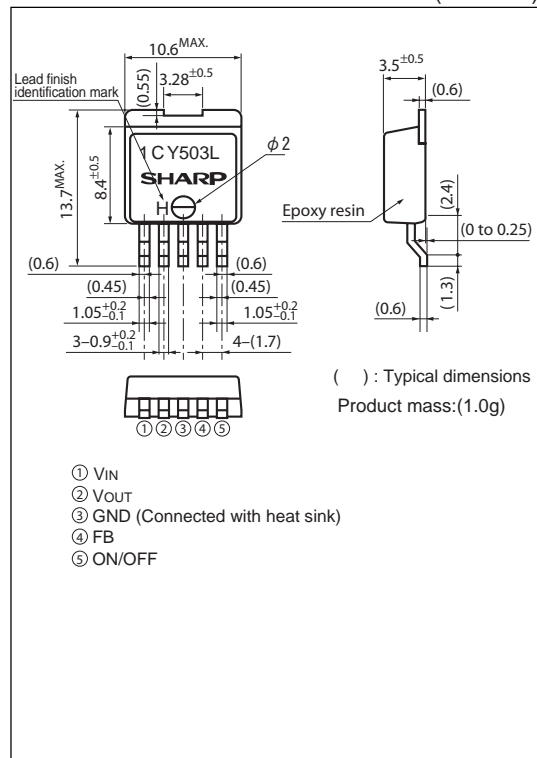

Lead finish: Lead-free solder plating  
(Composition: Sn2Cu)

Notice The content of data sheet is subject to change without prior notice.

In the absence of confirmation by device specification sheets, SHARP takes no responsibility for any defects that may occur in equipment using any SHARP devices shown in catalogs, data books, etc. Contact SHARP in order to obtain the latest device specification sheets before using any SHARP device.

### Electrical Characteristics

(Unless otherwise specified, condition shall be  $V_{IN}=12V, I_o=0.5A, ON-OFF$  terminals is open,  $T_a=25^\circ C$ )

Parameter	Symbol	Conditions	MIN.	TYP.	MAX.	Unit
Input voltage range	PQ1CY333LZPH	—	5.5	—	30	V
	PQ1CY503LZPH		7	—	40	
Output saturation voltage	$V_{SAT}$	$I_{sw}=3A$	—	1.4	1.8	V
Output voltage	PQ1CY333LZPH	—	3.218	3.3	3.382	V
	PQ1CY503LZPH		4.875	5	5.125	
Temperature change in reference voltage	$\Delta V_{REF}$	$T_j=0$ to $125^\circ C$	—	$\pm 0.5$	—	%
Load regulation	$ RegL $	$I_o=0.5$ to $3A$	—	0.2	1.5	%
Line regulation	$ RegI $	PQ1CY333LZPH: $V_{IN}=5.8$ to $25V$ PQ1CY503LZPH: $V_{IN}=8$ to $35V$	—	1.3	2.5	%
Efficiency	PQ1CY333LZPH	$I_o=3A$	—	77	—	%
	PQ1CY503LZPH		—	80	—	
Oscillation frequency	$f_o$	—	135	150	165	kHz
Temperature change in oscillator frequency	$\Delta f_o$	$T_j=0$ ~ $125^\circ C$	—	$\pm 2$	—	%
Over current detector level	$I_L$	Switching current peak	3.6	4.7	5.8	A
Off-state current for control	$I_{C(OFF)}$	5pin=2.5V	—	5	—	$\mu A$
On-state current for control	$I_{C(ON)}$	5pin=0.5V	—	0.1	—	$\mu A$
ON threshold voltage	$V_{THON}$	4pin=0V, 5pin	0.8	1.5	2	V
Stand-by current	$I_{SD}$	$V_{IN}=40V, 5pin=5V$	—	150	400	$\mu A$
Output off-state consumption current	$I_{QS}$	$V_{IN}=40V, 4pin=V_o+10\%$	—	8	16	mA

Fig.1 Standard measuring circuit

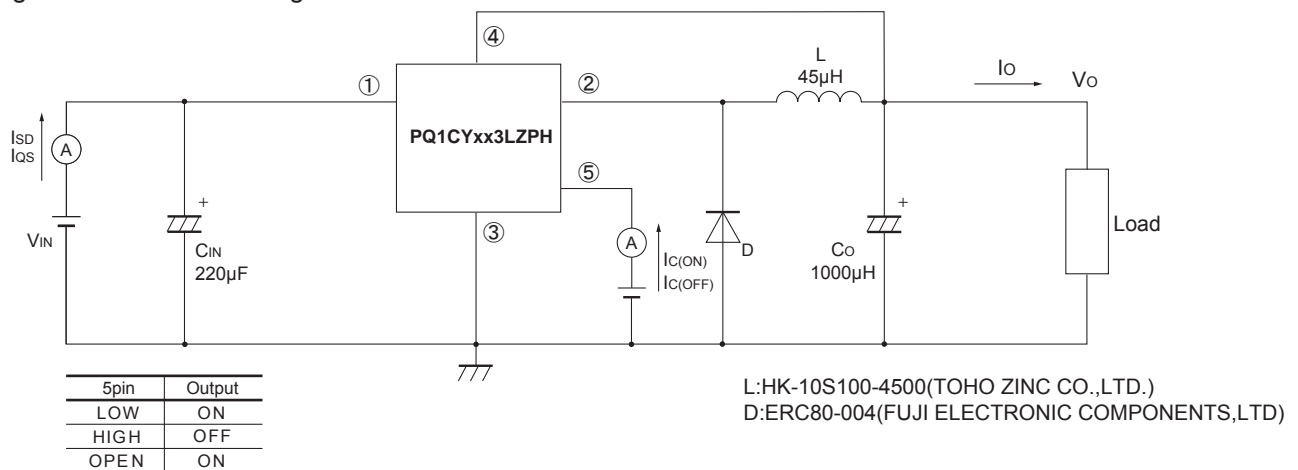
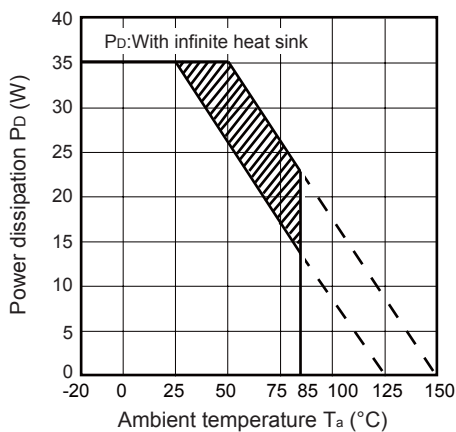

Fig.2 Power Dissipation vs. Ambient Temperature



Note) Oblique line portion: Overheat protection may operate in this area

Fig.3 Overcurrent Protection Characteristics (PQ1CY333LZPH)

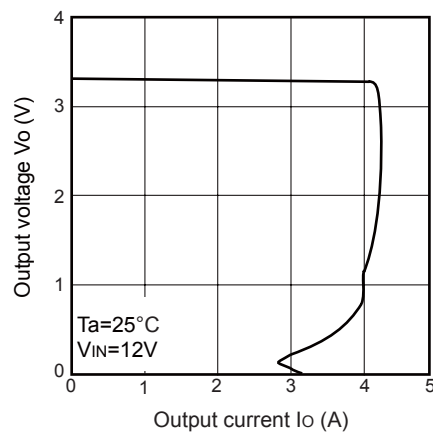

Fig.4 Overcurrent Protection Characteristics (PQ1CY503LZPH)

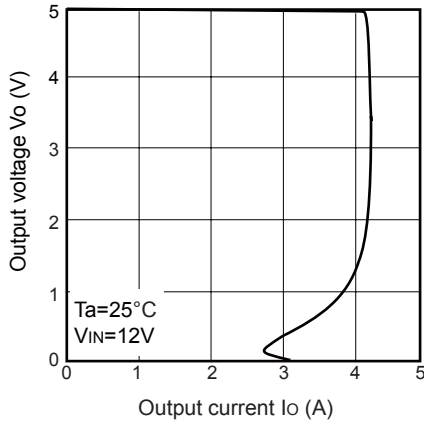

Fig.5 Efficiency vs. Input Voltage (PQ1CY333LHZPH)

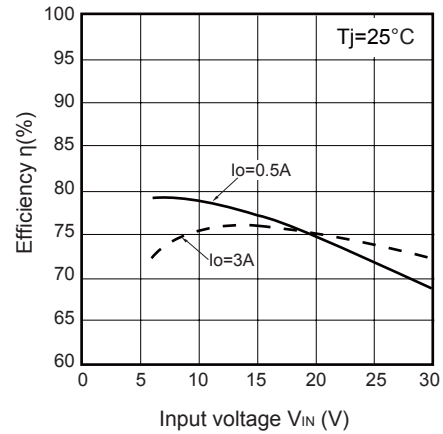

Fig.6 Efficiency vs. Input Voltage (PQ1CY503LHZPH)

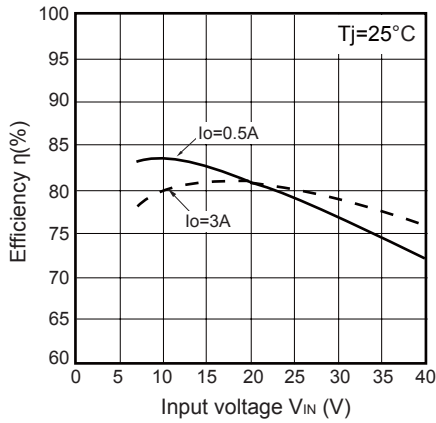

Fig.7 Output Saturation Voltage vs. Switching Current

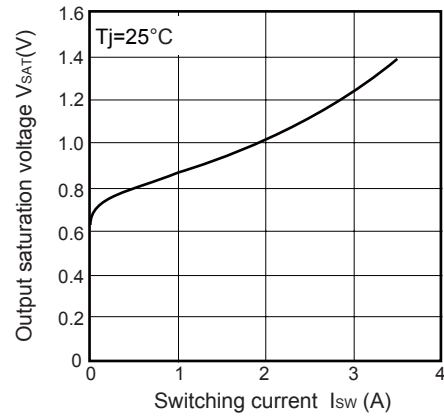

Fig.8 Stand-by Current vs. Input Voltage

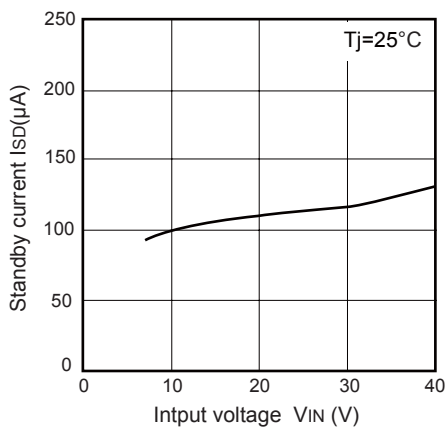

Fig.9 Output Voltage Fluctuation vs. Junction Temperature

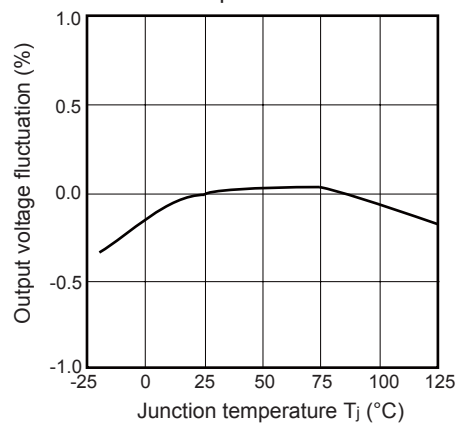

Fig.10 Load Regulation vs. Output Current(PQ1CY333LZPH)

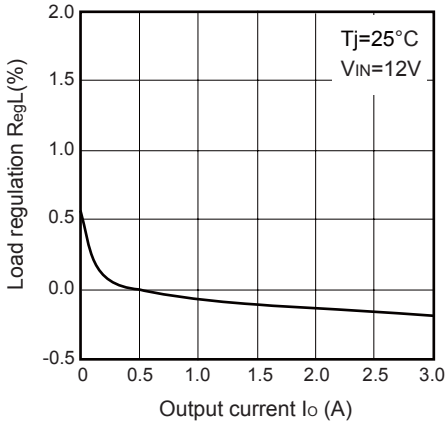

Fig.11 Load Regulation vs. Output Current(PQ1CY503LZPH)

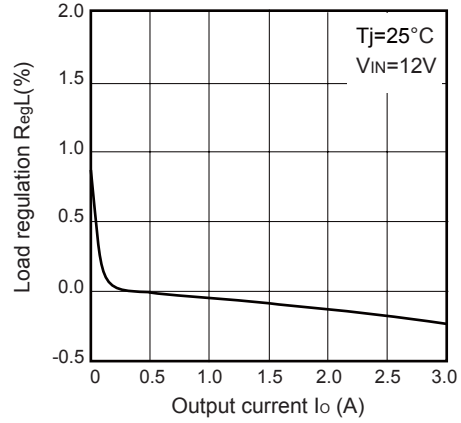

Fig.12 Line Regulation vs. Input Voltage

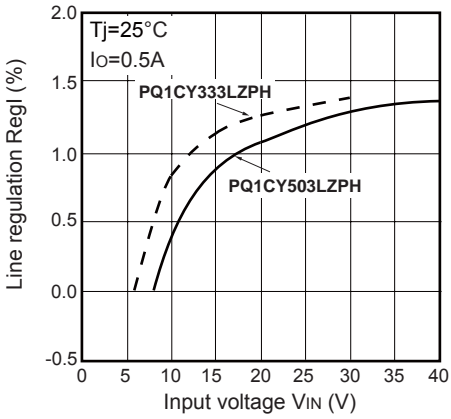

Fig.13 Oscillation Frequency Fluctuation vs. Junction Temperature

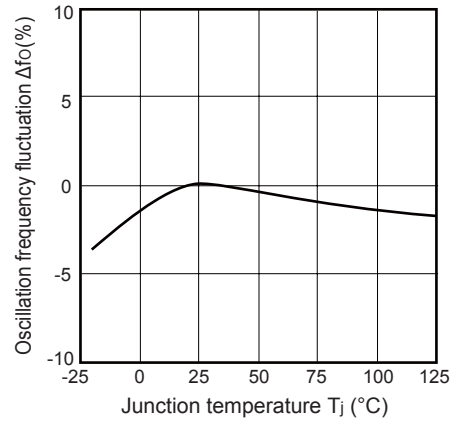

Fig.14 Overcurrent Detecting Level Fluctuation vs. Junction Temperature

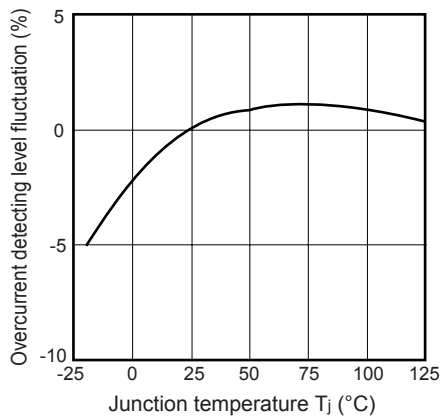

Fig.15 ON Threshold Voltage vs. Junction Temperature

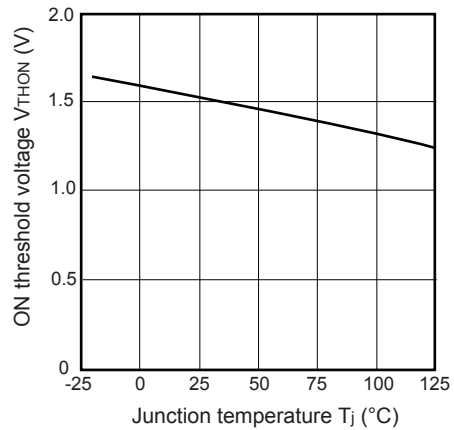

Fig.16 Operating Dissipation Current vs. Input Voltage (PQ1CY333LZPH)

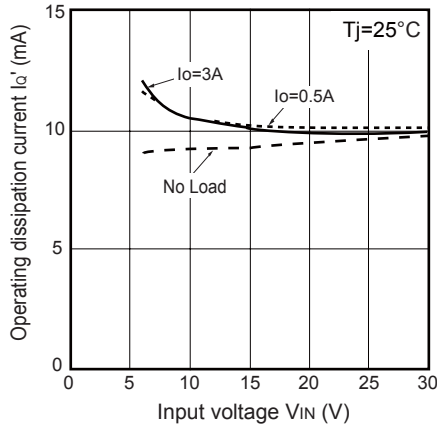

Fig.17 Operating Dissipation Current vs. Input Voltage (PQ1CY503LZPH)

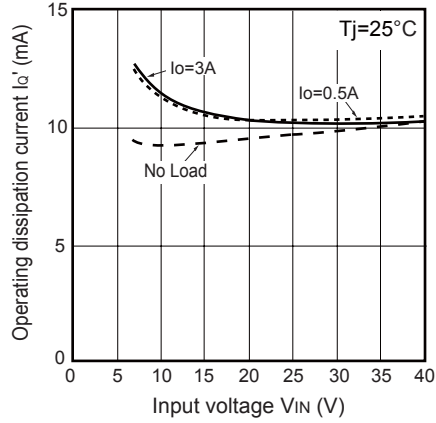

Fig.18 Power Dissipation vs. Ambient Temperature (Typical Value)

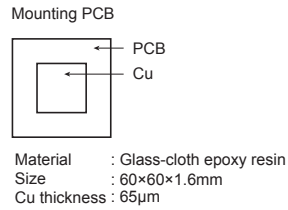
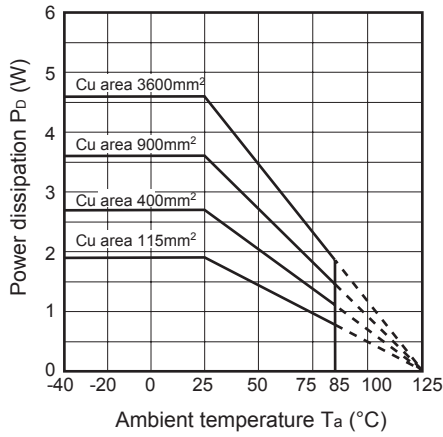

Fig.19 Block diagram

