

PE9304

Rad Hard for Space Applications

Product Description

The PE9304 is a high-performance CMOS prescaler with a fixed divide ratio of 2. Its operating frequency range is 1GHz to 7GHz. The PE9304 operates on a nominal 3 V supply and draws only 13.5mA. It is packaged in a small 8-lead ceramic SOIC and is ideal for frequency scaling and clock generation solutions.

The PE9304 is manufactured in Peregrine's patented Ultra-Thin Silicon (UTSi[®]) CMOS process, offering the performance of GaAs with the economy and integration of conventional CMOS.

1- 7 GHz Low Power CMOS Divide-by-2 Prescaler

Features

- Fixed divide ratio of 2
- Low-power operation: 13.5mA typical @ 3 V
- Small package: 8-lead Ceramic SOIC
- Guaranteed 100Krad(Si) Total Dose Performance
- Superior Single Event Upset Immunity

Figure 1. Functional Schematic Diagram

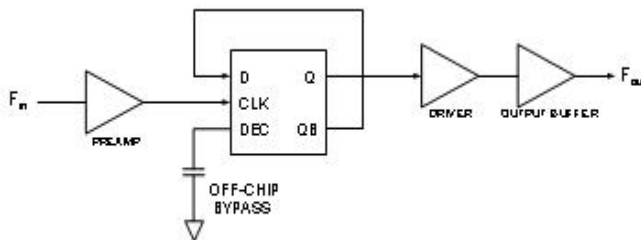

Figure 2. Package Type

8 Lead Gullwing Glass Flatpack

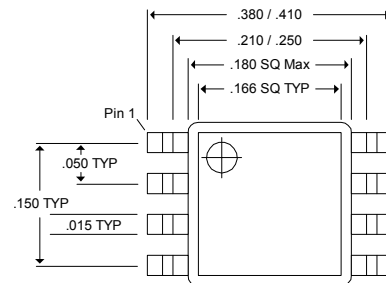
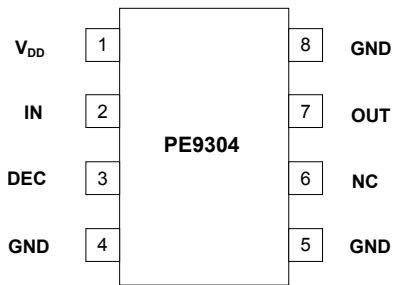

Table 1. Electrical Specifications ($Z_S = Z_L = 50 \Omega$)

$V_{DD} = 3.0 \text{ V}$, $-40^\circ \text{ C} \leq T_A \leq 85^\circ \text{ C}$, unless otherwise specified

Parameter	Conditions	Minimum	Typical	Maximum	Units
Supply Voltage		2.85	3.0	3.15	V
Supply Current			13.5	18.0	mA
Input Frequency (F_{in})		1		7	GHz
Input Sensitivity (P_{in})	$1\text{GHz} \leq F_{in} < 2\text{GHz}$	+5		+12	dBm
	$2\text{GHz} \leq F_{in} < 6\text{GHz}$	0		+12	dBm
	$6\text{GHz} \leq F_{in} \leq 7\text{GHz}$	+5		+12	dBm
Output Power (P_{out})	$1\text{GHz} \leq F_{in} < 2\text{GHz}$	0			dBm
	$2\text{GHz} \leq F_{in} < 6\text{GHz}$	-7			
	$6\text{GHz} \leq F_{in} \leq 7\text{GHz}$	-12			

Figure 3. Pin Configuration

Table 2. Pin Descriptions

Pin No.	Pin Name	Description
1	V _{DD}	Power supply pin. Bypassing is required (eg. 1000pF & 100pF).
2	IN	Input signal pin. Should be coupled with a capacitor (eg. 2.2pF).
3	DEC	Decoupling Pin. This pin should have two capacitors in parallel (eg. 1000pf, 10nF)
4	GND	Ground pin. Ground pattern on the board should be as wide as possible to reduce ground impedance.
5	GND	Ground pin.
6	NC	No connection. This pin should be left open.
7	OUT	Divided frequency output pin. This pin should be coupled with a capacitor (eg. 2.2pF).
8	GND	Ground Pin.

Table 3. Absolute Maximum Ratings

Symbol	Parameter/Conditions	Min	Max	Units
V _{DD}	Supply voltage		3.3	V
P _{in}	Input Power		+12	dBm
V _{IN}	Voltage on input	-0.3	V _{DD} +0.3	V
T _{ST}	Storage temperature range	-65	150	°C
T _{OP}	Operating temperature range	-40	85	°C
VESD	ESD voltage (Human Body Model, MIL-STD 883 Method 3015.7)		500	V
	ESD voltage (Machine Model, JEDEC, JESD22-A114-B)		50	V
	ESD voltage (Charged Device Model, JEDEC, JESD22-C101)		1000	V

Electrostatic Discharge (ESD) Precautions

When handling this *UTSi*[®] device, observe the same precautions that you would use with other ESD-sensitive devices. Although this device contains circuitry to protect it from damage due to ESD, precautions should be taken to avoid exceeding the rating specified in Table 3.

Latch-Up Avoidance

Unlike conventional CMOS devices, *UTSi*[®] CMOS devices are immune to latch-up.

Device Functional Considerations

The *PE9304* divides a 1GHz – 7GHz input signal by a factor of two thereby producing an output frequency at half the input frequency. To work properly at higher frequencies, the input and output signals (pins 2 & 7) must be AC coupled via an external capacitor, as shown in the test circuit in Figure 7.

The ground pattern on the board should be made as wide as possible to minimize ground impedance.

Typical Performance Data: $V_{DD} = 3.0V$

Figure 4. Input Sensitivity

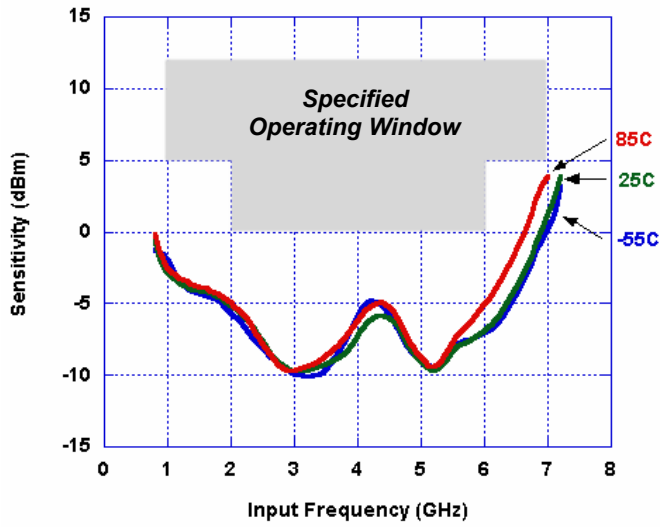

Figure 5. Device Current

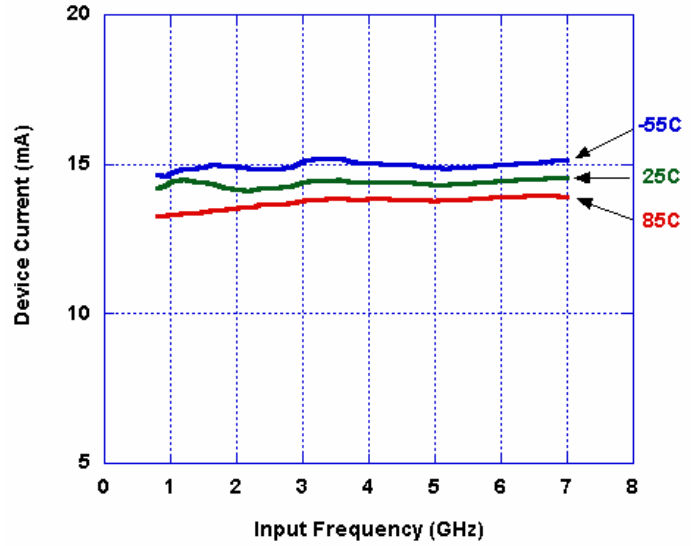

Figure 6. Output Power

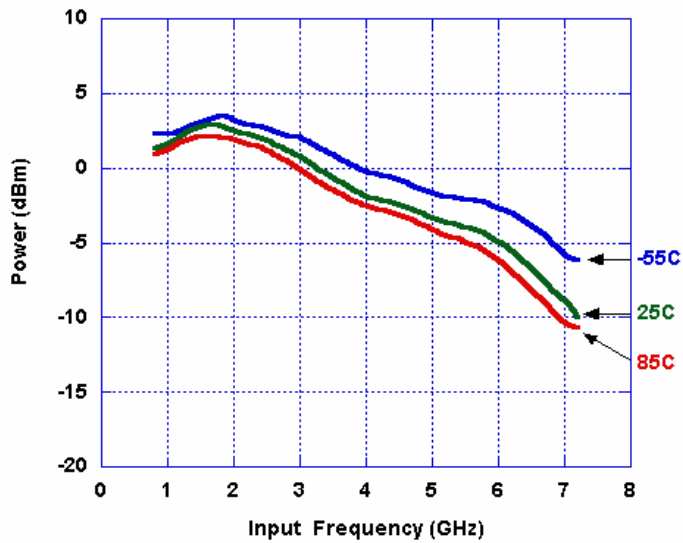

Figure 7. Evaluation Board Schematic Diagram

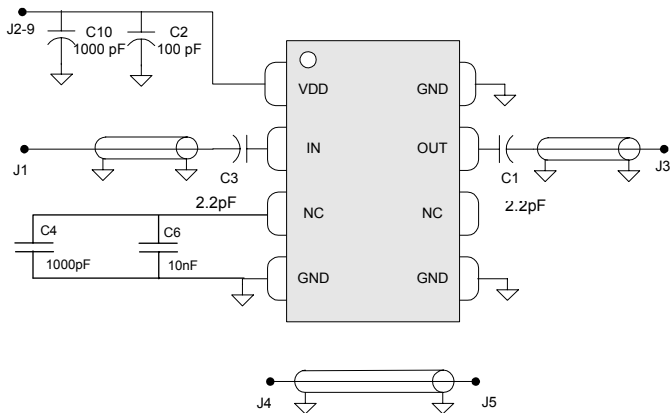
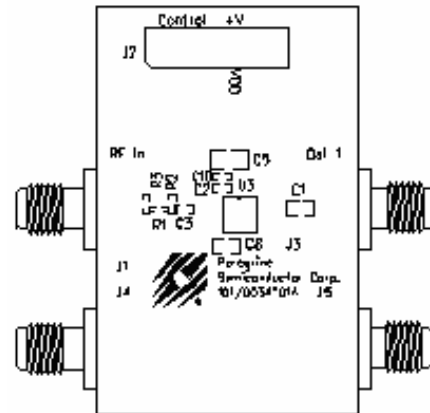

Figure 8. Evaluation Board Layout



Evaluation Kit Operation

The Ceramic SOIC Prescaler Evaluation Board was designed to help customers evaluate the *PE9304* divide-by-2 prescaler. On this board, the device input (pin 2) is connected to the SMA connector J1 through a 50 Ω transmission line. A series capacitor (C3) provides the necessary DC block for the device input. A value of 2.2pF was used for the evaluation board; other applications may require a different value.

The device output (pin 7) is connected to SMA connector J3 through a 50 Ω transmission line. A series capacitor (C1) provides the necessary DC block for the device output. This capacitor value must be chosen to have low impedance at the desired output frequency of the device. A value of 2.2pF was chosen for the evaluation board.

J2 provides DC power to the device via pin 1. Two decoupling capacitors (C2=1000pF, C10=100pF) are included on this trace. It is the responsibility of the customer to determine proper supply decoupling for their design application.

The board is constructed using 4 layers. The top and bottom layers are comprised of Rogers low loss 4350 material having a core thickness of 0.010"; while the internal layers are comprised of FR-4. The overall board thickness is 0.062".

Applications Support

If you have a problem with your evaluation kit or if you have applications questions call (858) 455-0660 and ask for applications support. You may also contact us by fax or e-mail:

Fax: (858) 455-0770

E-Mail: help@peregrine-semi.com

Figure 9. Package Drawing

8 Lead Gullwing Glass Flatpack

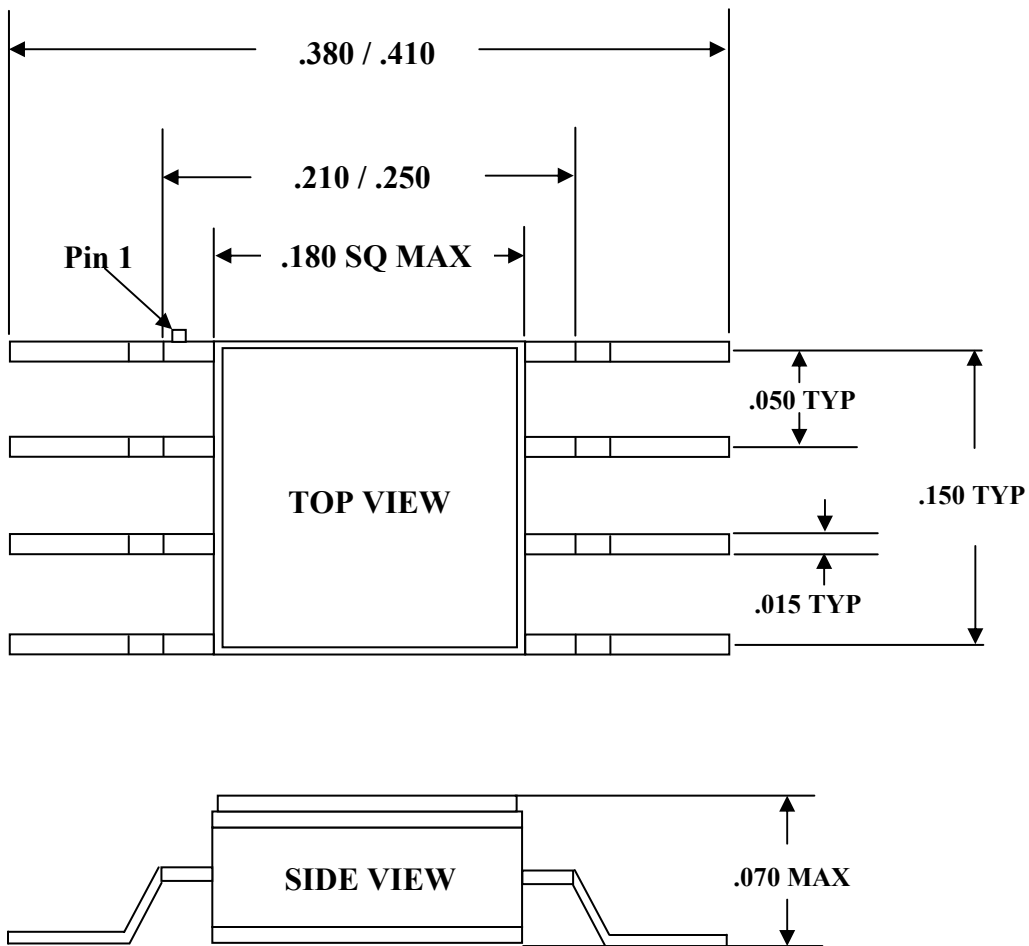

Table 4. Ordering Information

Order Code	Part Marking	Description	Package	Shipping Method
9304-01	PE9304	PE9304-08CFPG-1A Engineering Samples	Gullwing Glass Flatpack	20 / Tray
9304-11	PE9304	PE9304-08CFPG-1A Flight Units	Gullwing Glass Flatpack	50 / Tray
9304-00	PE9304-EK	PE9304 Evaluation Kit	Evaluation Kit	1 / Box

Sales Offices

United States

Peregrine Semiconductor Corp.

6175 Nancy Ridge Drive
San Diego, CA 92121
Tel 1-858-455-0660
Fax 1-858-455-0770

Japan

Peregrine Semiconductor K.K.

5A-5, 5F Imperial Tower
1-1-1 Uchisiwaicho,
Chiyoda-ku, Tokyo, Japan
100-011
Tel. 011-81-3-3502-5211
Fax. 011-81-3-3502-5213

Europe

Peregrine Semiconductor Europe

Aix-En-Provence Office
Parc Club du Golf, bat 9
13856 Aix-En-Provence Cedex 3
France
Tel 33-0-4-4239-3360
Fax 33-0-4-4239-7227

For a list of representatives in your area, please refer to our Web site at: <http://www.peregrine-semi.com>

Data Sheet Identification

Advance Information

The product is in a formative or design stage. The data sheet contains design target specifications for product development. Specifications and features may change in any manner without notice.

Preliminary Specification

The data sheet contains preliminary data. Additional data may be added at a later date. Peregrine reserves the right to change specifications at any time without notice in order to supply the best possible product.

Product Specification

The data sheet contains final data. In the event Peregrine decides to change the specifications, Peregrine will notify customers of the intended changes by issuing a PCN (Product Change Notice).

The information in this data sheet is believed to be reliable. However, Peregrine assumes no liability for the use of this information. Use shall be entirely at the user's own risk.

No patent rights or licenses to any circuits described in this data sheet are implied or granted to any third party.

Peregrine's products are not designed or intended for use in devices or systems intended for surgical implant, or in other applications intended to support or sustain life, or in any application in which the failure of the Peregrine product could create a situation in which personal injury or death might occur. Peregrine assumes no liability for damages, including consequential or incidental damages, arising out of the use of its products in such applications.

Peregrine products are protected under one or more of the following U.S. patents: 6,090,648; 6,057,555; 5,973,382; 5,973,363; 5,930,638; 5,920,233; 5,895,957; 5,883,396; 5,864,162; 5,863,823; 5,861,336; 5,663,570; 5,610,790; 5,600,169; 5,596,205; 5,572,040; 5,492,857; 5,416,043. Other patents are pending.

Peregrine, the Peregrine logotype, Peregrine Semiconductor Corp., and UTSi are registered trademarks of Peregrine Semiconductor Corporation. Copyright © 2002 Peregrine Semiconductor Corp. All rights reserved.