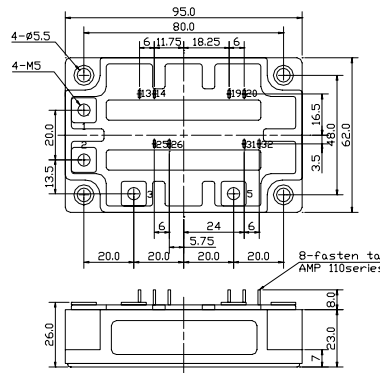
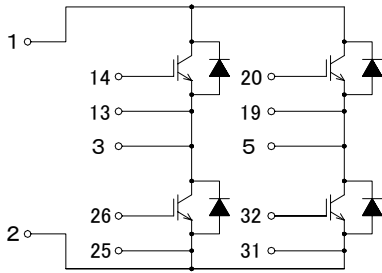


CIRCUIT

OUTLINE DRAWING



8- fasten- tab No 110

Dimension(mm)

Approximate Weight : 430g

MAXIMUM RATINGS (Tc=25°C)

Item	Symbol	PBMB75B12	Unit
Collector-Emitter Voltage	V <sub>CEs</sub>	1200	V
Gate - Emitter Voltage	V <sub>GEs</sub>	+/- 20	V
Collector Current	DC	I <sub>C</sub>	75
	1 ms	I <sub>CP</sub>	150
Collector Power Dissipation	P <sub>C</sub>	400	W
Junction Temperature Range	T <sub>j</sub>	-40 to +150	°C
Storage Temperature Range	T <sub>stg</sub>	-40 to +125	°C
Isolation Voltage (Terminal to Base AC, 1 min.)	V <sub>ISO</sub>	2500	V
Mounting Torque	Module Base to Heatsink	F <sub>TOR</sub>	2
	Bus Bar to Main Terminals		
			N•m

ELECTRICAL CHARACTERISTICS (Tc=25°C)

Characteristic	Symbol	Test Condition	Min.	Typ.	Max.	Unit
Collector-Emitter Cut-Off Current	I <sub>CEs</sub>	V <sub>CE</sub> =1200V, V <sub>GE</sub> =0V	-	-	2.0	mA
Gate-Emitter Leakage Current	I <sub>GES</sub>	V <sub>GE</sub> =+/- 20V, V <sub>CE</sub> =0V	-	-	1.0	μA
Collector-Emitter Saturation Voltage	V <sub>CE(sat)</sub>	I <sub>C</sub> =75A, V <sub>GE</sub> =15V	-	1.9	2.4	V
Gate-Emitter Threshold Voltage	V <sub>GE(th)</sub>	V <sub>CE</sub> =5V, I <sub>C</sub> =75mA	4.0	-	8.0	V
Input Capacitance	C <sub>ies</sub>	V <sub>CE</sub> =10V, V <sub>GE</sub> =0V, f=1MHz	-	6300	-	pF
Switching Time	Rise Time	V <sub>CC</sub> = 600V R <sub>L</sub> = 8 ohm R <sub>G</sub> = 13 ohm V <sub>GE</sub> = +/- 15V	-	0.25	0.45	μs
	Turn-on Time		-	0.40	0.70	
	Fall Time		-	0.25	0.35	
	Turn-off Time		-	0.80	1.00	

FREE WHEELING DIODES RATINGS & CHARACTERISTICS (Tc=25°C)

Item	Symbol	Rated Value	Unit
Forward Current	DC	I <sub>F</sub>	75
	1 ms	I <sub>FM</sub>	150
			A

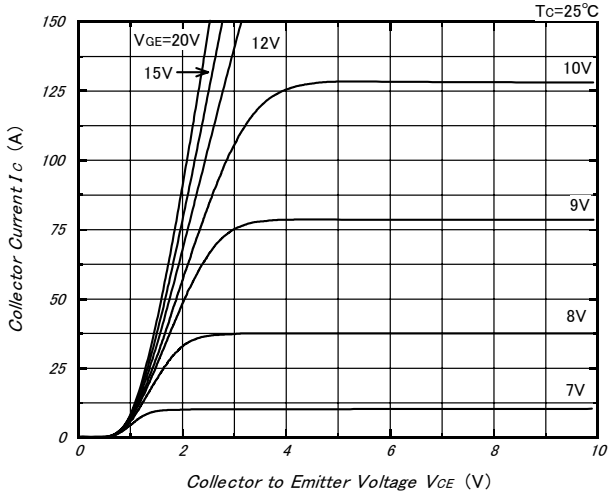
Characteristic	Symbol	Test Condition	Min.	Typ.	Max.	Unit
Peak Forward Voltage	V <sub>F</sub>	I <sub>F</sub> =75A, V <sub>GE</sub> =0V	-	1.9	2.4	V
Reverse Recovery Time	t <sub>rr</sub>	I <sub>F</sub> =75A, V <sub>GE</sub> =-10V, di/dt=150A/μs	-	0.2	0.3	μs

THERMAL CHARACTERISTICS

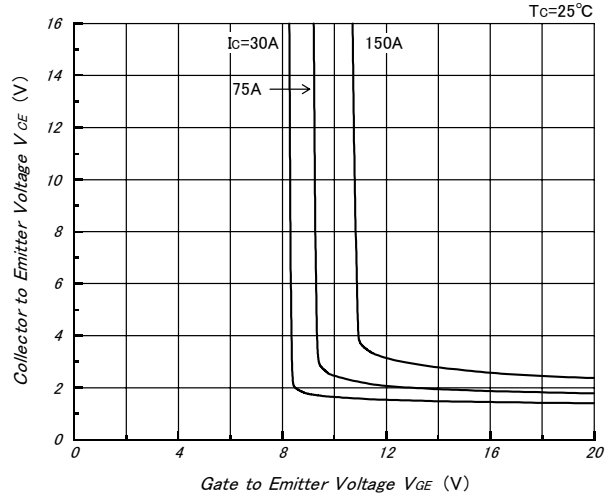
Characteristic	Symbol	Test Condition	Min.	Typ.	Max.	Unit
Thermal Impedance	IGBT	Junction to Case	-	-	0.3	°C/W
	DIODE		-	-	0.6	

**PBMB75B12**

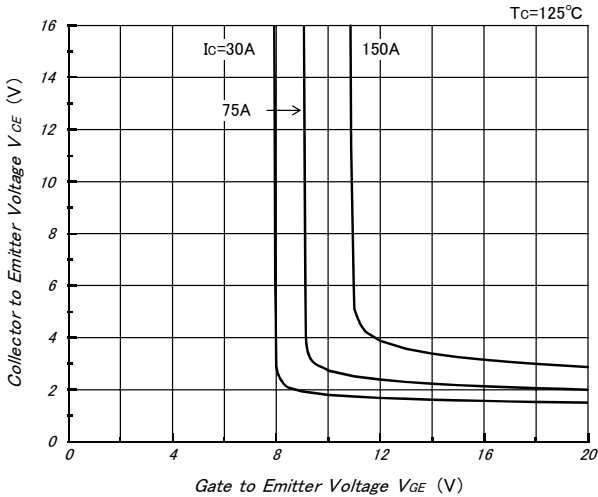
*Fig.1- Output Characteristics (Typical)*



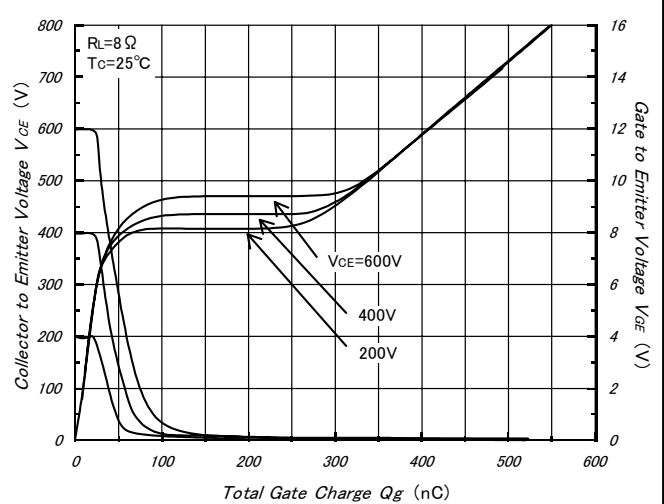
*Fig.2- Collector to Emitter On Voltage vs. Gate to Emitter Voltage (Typical)*



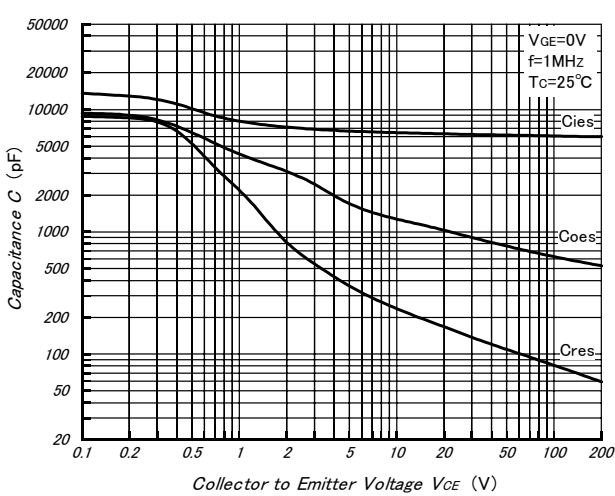
*Fig.3- Collector to Emitter On Voltage vs. Gate to Emitter Voltage (Typical)*



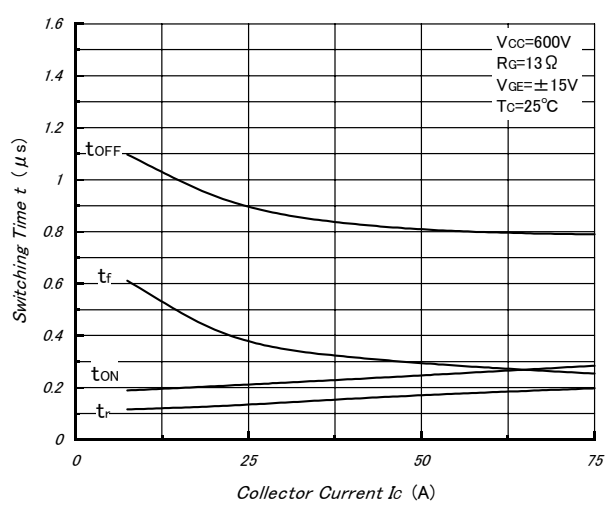
*Fig.4- Gate Charge vs. Collector to Emitter Voltage (Typical)*



*Fig.5- Capacitance vs. Collector to Emitter Voltage (Typical)*

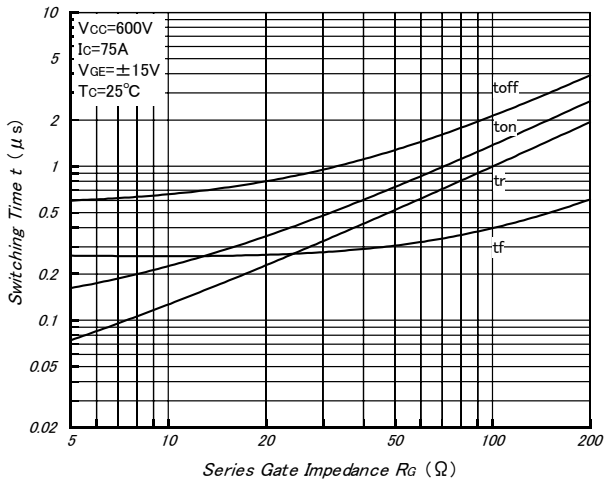


*Fig.6- Collector Current vs. Switching Time (Typical)*

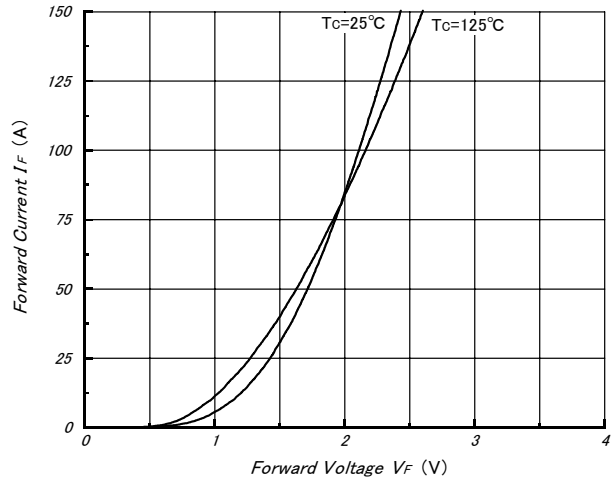


**PBMB75B12**

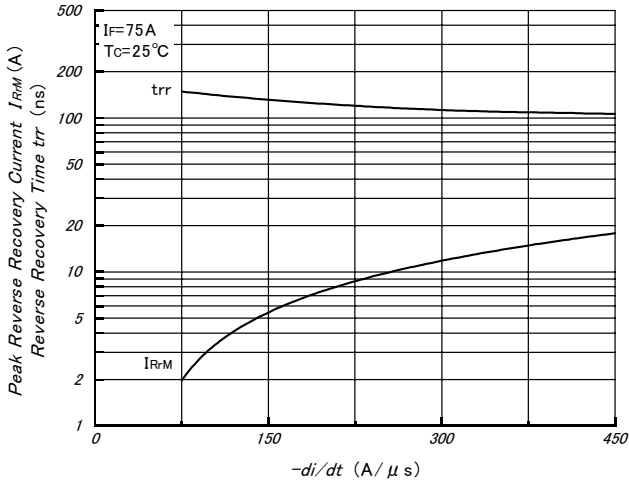
*Fig.7- Series Gate Impedance vs. Switching Time (Typical)*



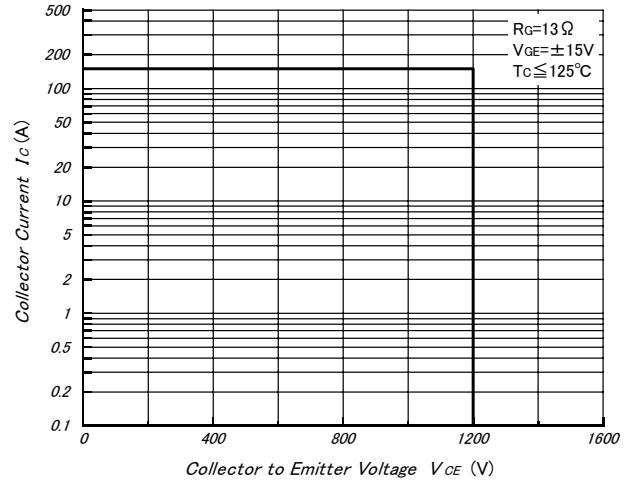
*Fig.8- Forward Characteristics of Free Wheeling Diode (Typical)*



*Fig.9- Reverse Recovery Characteristics (Typical)*



*Fig.10- Reverse Bias Safe Operating Area (Typical)*



*fig11-Tansient Thermal Impedance*

