

● Features

1. Current transfer ratio

CTR: MIN.60 at $I_f = \pm 1\text{mA}$ $V_{ce} = 5\text{V}$

2. High isolation voltage between input and output (Viso : 5000Vrms).

3. Compact dual-in-line package.

4. AC input.

● Applications

1. Programmable Controller Applications for Low Input Photocouplers and High Vceo Photocouplers.

2. Telephone sets, telephone exchangers.

3. System appliances. ● Limit Switches ● Sensors ● Thermostats ● Transducers etc.

4. Signal transmission between circuits of different potentials and impedances.

1. OUTSIDE DIMENSION : UNIT (mm)

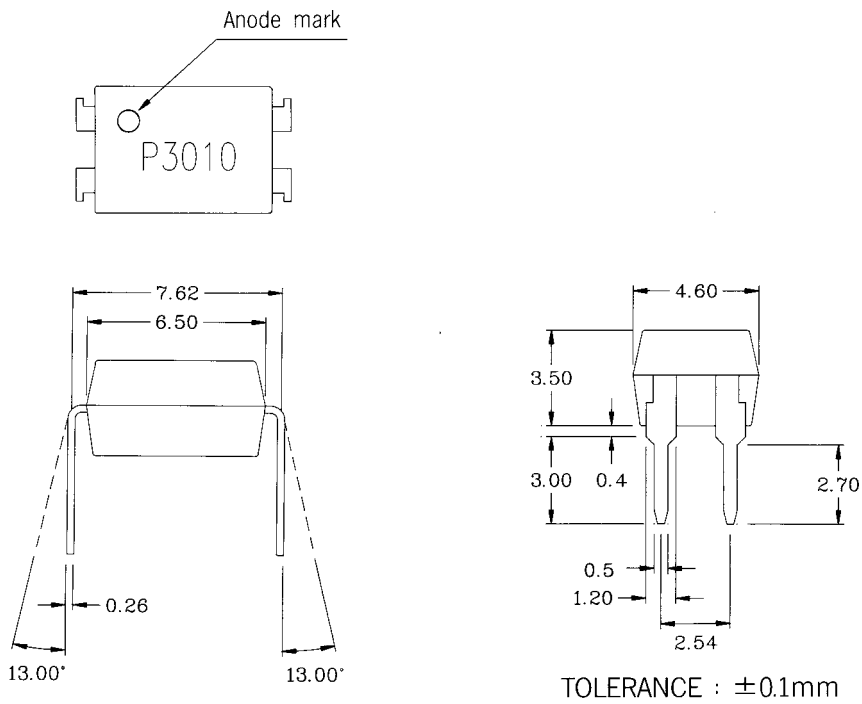

2. SCHEMATIC : TOP VIEW

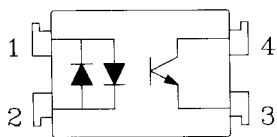

1. Anode, Cathode
2. Anode, Cathode
3. Emitter
4. Collector

● Absolute Maximum Ratings

(Ta=25°C)

	Parameter	Symbol	Rating	Unit
Input	Forward current	I _F	±50	mA
	Peak forward current	I _{FM}	±1	A
	Power dissipation	P _b	70	mW
Output	Collector-emitter voltage	V _{CEO}	60	V
	Emitter-collector voltage	V _{ECO}	6	V
	Collector current	I _c	50	mA
	Collector power dissipation	P _c	150	mW

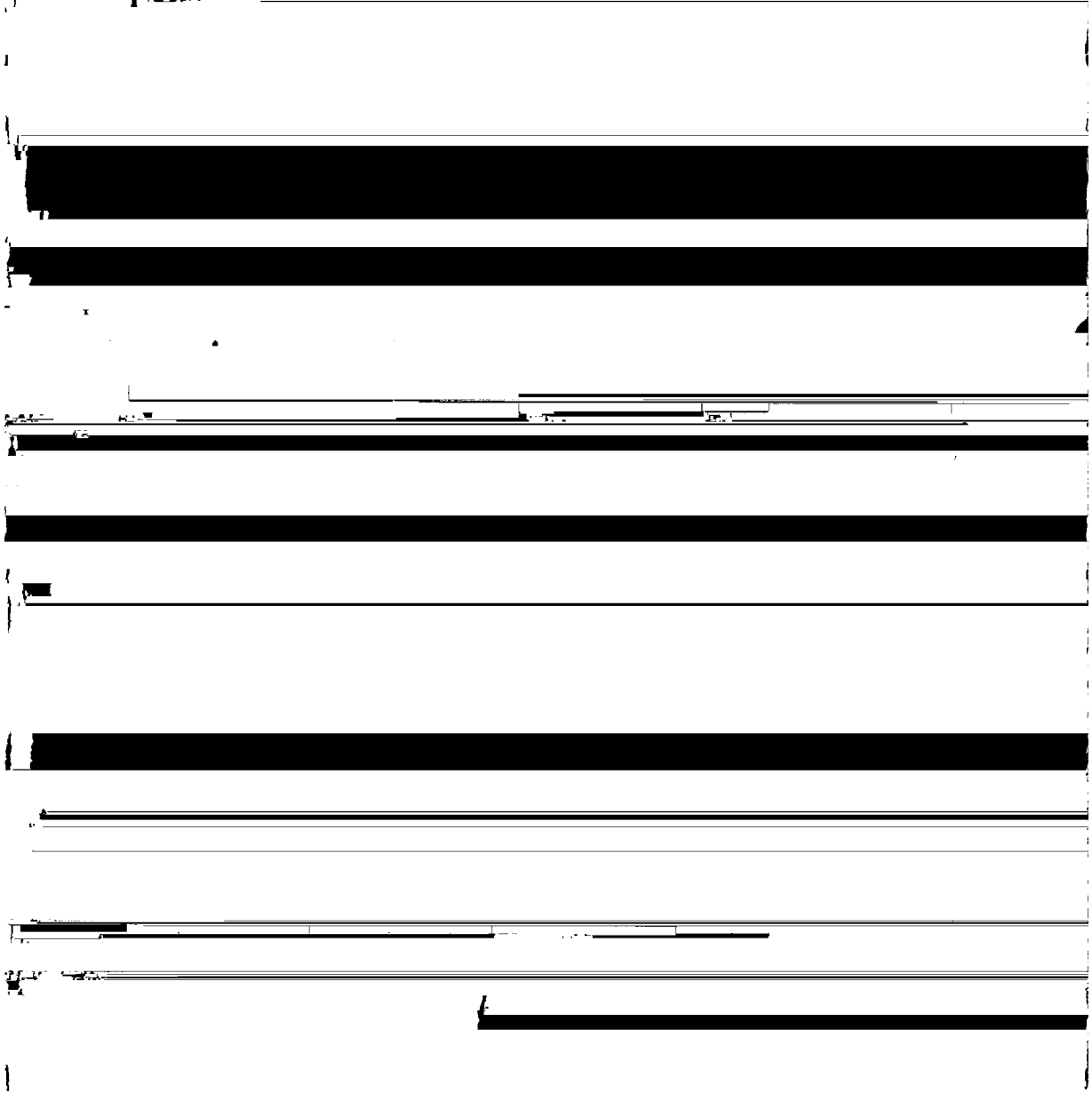

Fig 2 Collector Power Dissipation vs. Ambient Temperature

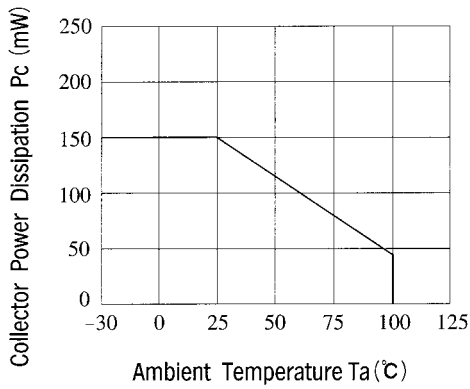

Fig 3 Collector Dark Current vs. Ambient Temperature

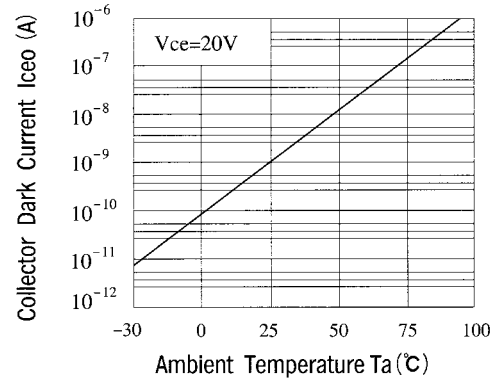

Fig 4 Forward Current vs. Ambient Temperature

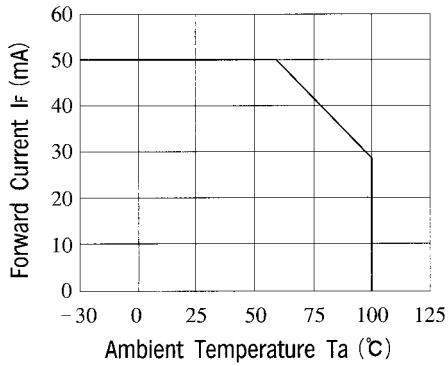

Fig 5 Forward Current vs. Forward Voltage

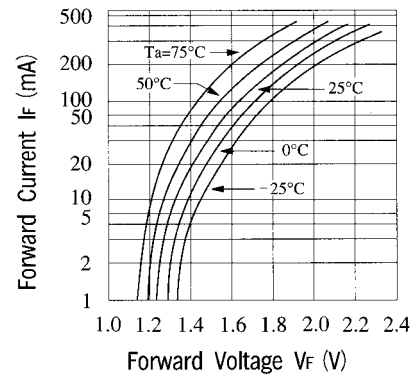

Fig 6 Collector Current vs. Collector-emitter Voltage

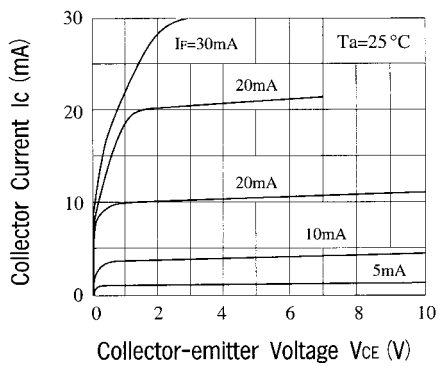

Fig 7 Relative Current Transfer Ratio vs. Ambient Temperature

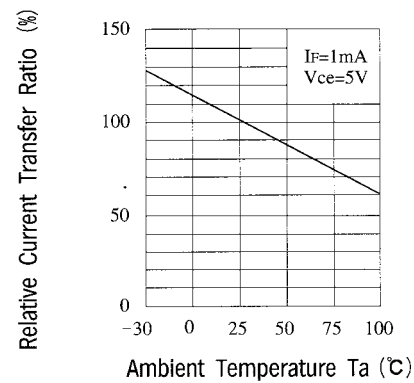

Fig. 8 Collector-emitter Saturation Voltage vs. Ambient Temperature

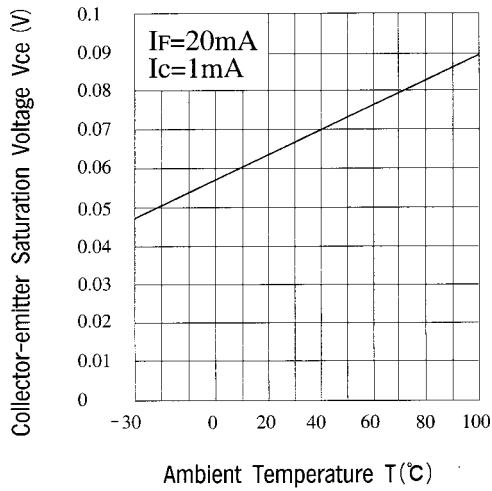

Fig. 9 Collector-emitter Saturation Voltage vs. Forward Current

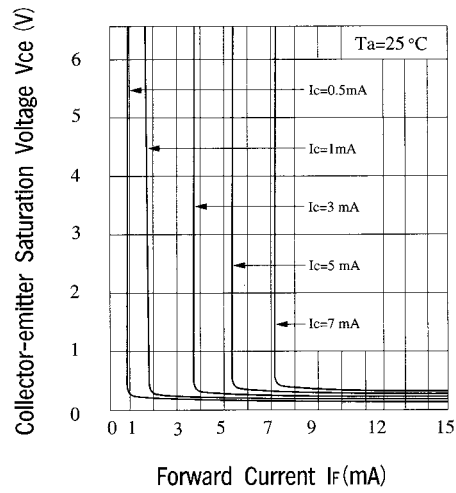

Fig. 10 Response Time vs. Load Resistance

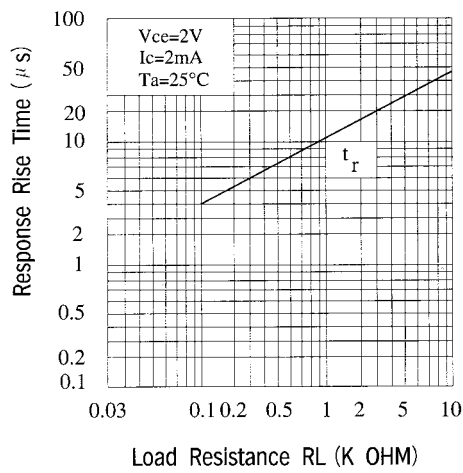

Fig. 11 Response Time vs. Load Resistance

