

NTR1P02T1

Power MOSFET

-20 V, -1 A, P-Channel SOT-23 Package

Features

- Ultra Low On-Resistance Provides Higher Efficiency and Extends Battery Life
 $R_{DS(on)} = 0.180 \Omega$, $V_{GS} = -10 \text{ V}$
 $R_{DS(on)} = 0.280 \Omega$, $V_{GS} = -4.5 \text{ V}$
- Power Management in Portable and Battery-Powered Products
- Miniature SOT-23 Surface Mount Package Saves Board Space
- Mounting Information for SOT-23 Package Provided

Applications

- DC-DC Converters
- Computers
- Printers
- PCMCIA Cards
- Cellular and Cordless Telephones

MAXIMUM RATINGS ($T_J = 25^\circ\text{C}$ unless otherwise noted)

Rating	Symbol	Value	Unit
Drain-to-Source Voltage	V_{DS}	-20	V
Gate-to-Source Voltage - Continuous	V_{GS}	± 20	V
Drain Current	I_D	-1.0	A
- Continuous @ $T_A = 25^\circ\text{C}$	I_{DM}	-2.67	
- Pulsed Drain Current ($t_p \leq 1 \mu\text{s}$)			
Total Power Dissipation @ $T_A = 25^\circ\text{C}$	P_D	400	mW
Operating and Storage Temperature Range	T_J, T_{stg}	-55 to 150	$^\circ\text{C}$
Thermal Resistance - Junction-to-Ambient	$R_{\theta JA}$	300	$^\circ\text{C/W}$
Maximum Lead Temperature for Soldering Purposes, (1/8" from case for 10 s)	T_L	260	$^\circ\text{C}$

Maximum ratings are those values beyond which device damage can occur. Maximum ratings applied to the device are individual stress limit values (not normal operating conditions) and are not valid simultaneously. If these limits are exceeded, device functional operation is not implied, damage may occur and reliability may be affected.



ON Semiconductor®

<http://onsemi.com>

$V_{(BR)DSS}$	$R_{DS(on)}$ TYP	I_D MAX
-20 V	148 m Ω @ -10 V	-1.0 A

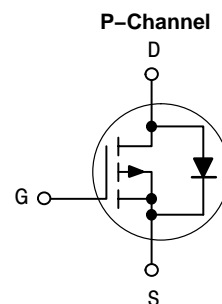

MARKING DIAGRAM/ PIN ASSIGNMENT

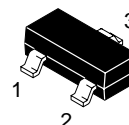

SOT-23
CASE 318
STYLE 21

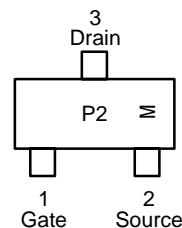

P2 = Specific Device Code
M = Date Code

ORDERING INFORMATION

Device	Package	Shipping†
NTR1P02T1	SOT-23	3000/Tape & Reel
NTR1P02T3	SOT-23	10,000/Tape & Reel

†For information on tape and reel specifications, including part orientation and tape sizes, please refer to our Tape and Reel Packaging Specification Brochure, BRD8011/D.

NTR1P02T1

ELECTRICAL CHARACTERISTICS (T_A = 25°C unless otherwise noted)

Characteristic	Symbol	Min	Typ	Max	Unit
OFF CHARACTERISTICS					
Drain-to-Source Breakdown Voltage (V _{GS} = 0 V, I _D = -10 μA) (Positive Temperature Coefficient)	V _{(BR)DSS}	-20	32		V mV/°C
Zero Gate Voltage Drain Current (V _{DS} = -20 V, V _{GS} = 0 V, T _J = 25°C) (V _{DS} = -20 V, V _{GS} = 0 V, T _J = 150°C)	I _{DSS}			-1.0 -10	μA
Gate-Body Leakage Current (V _{GS} = ±20 V, V _{DS} = 0 V)	I _{GSS}			±100	nA

ON CHARACTERISTICS (Note 1)

Gate Threshold Voltage (V _{DS} = V _{GS} , I _D = -250 μA) (Negative Temperature Coefficient)	V _{GS(th)}	-1.1	-1.9 -4.0	-2.3	V mV/°C
Static Drain-to-Source On-State Resistance (V _{GS} = -10 V, I _D = -1.5 A) (V _{GS} = -4.5 V, I _D = -0.75 A)	R _{DS(on)}		0.148 0.235	0.180 0.280	Ω

DYNAMIC CHARACTERISTICS

Input Capacitance (V _{DS} = -5 V, V _{GS} = 0 V, f = 1.0 MHz)	C _{iss}		165		pF
Output Capacitance (V _{DS} = -5 V, V _{GS} = 0 V, f = 1.0 MHz)	C _{oss}		110		
Reverse Transfer Capacitance (V _{DS} = -5 V, V _{GS} = 0 V, f = 1.0 MHz)	C _{rss}		35		

SWITCHING CHARACTERISTICS (Note 2)

Turn-On Delay Time (V _{DD} = -15 V, I _D = -1 A, V _{GS} = -5 V, R _G = 2.5 Ω)	t _{d(on)}		7.0		ns
Rise Time (V _{DD} = -15 V, I _D = -1 A, V _{GS} = -5 V, R _G = 2.5 Ω)	t _r		9.0		
Turn-Off Delay Time (V _{DD} = -15 V, I _D = -1 A, V _{GS} = -5 V, R _G = 2.5 Ω)	t _{d(off)}		9.0		
Fall Time (V _{DD} = -15 V, I _D = -1 A, V _{GS} = -5 V, R _G = 2.5 Ω)	t _f		3.0		
Total Gate Charge (V _{DS} = -15 V, V _{GS} = -5 V, I _D = -0.8 A)	Q _{tot}		2.5		nC
Gate-Source Charge (V _{DS} = -15 V, V _{GS} = -5 V, I _D = -0.8 A)	Q _{gs}		0.75		
Gate-Drain Charge (V _{DS} = -15 V, V _{GS} = -5 V, I _D = -0.8 A)	Q _{gd}		1.0		

BODY-DRAIN DIODE RATINGS (Note 1)

Diode Forward On-Voltage (Note 2) (I _S = -0.6 A, V _{GS} = 0 V) (I _S = -0.6 A, V _{GS} = 0 V, T _J = 150°C)	V _{SD}		-0.8 -0.6	-1.0	V
Reverse Recovery Time (I _S = -1 A, dI _S /dt = 100 A/μs, V _{GS} = 0 V)	t _{rr}		13.5		ns
	t _a		10.5		
	t _b		3.0		
Reverse Recovery Stored Charge (I _S = -1 A, dI _S /dt = 100 A/μs, V _{GS} = 0 V)	Q _{RR}		0.008		μC

1. Pulse Test: Pulse Width ≤ 300 μs, Duty Cycle ≤ 2%.
2. Switching characteristics are independent of operating junction temperature.

NTR1P02T1

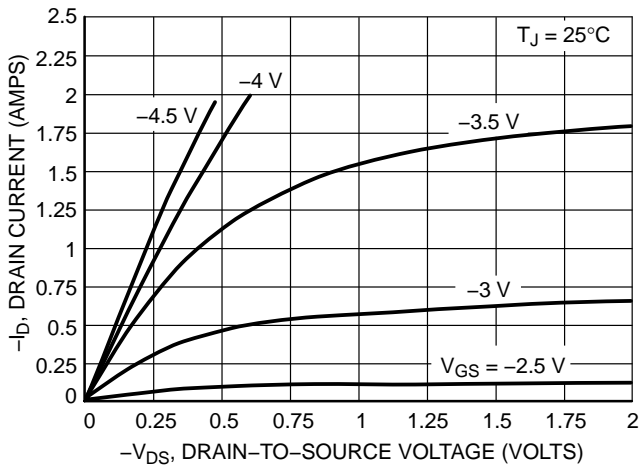

Figure 1. On-Region Characteristics

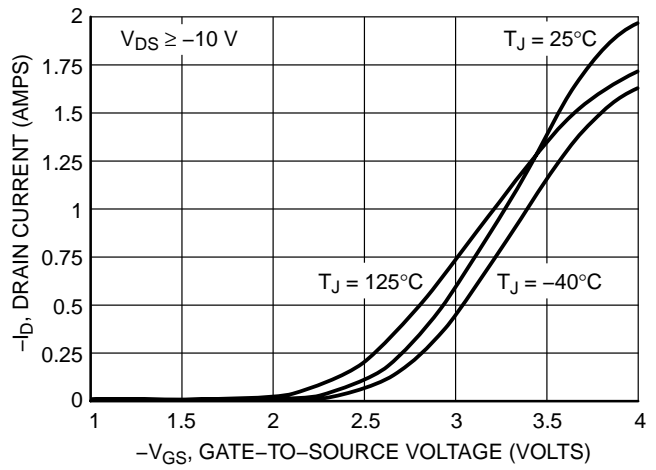

Figure 2. Transfer Characteristics

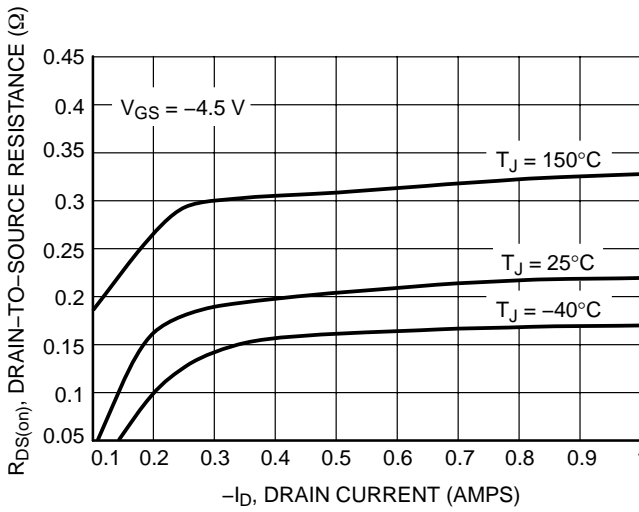

Figure 3. On-Resistance versus Drain Current and Temperature

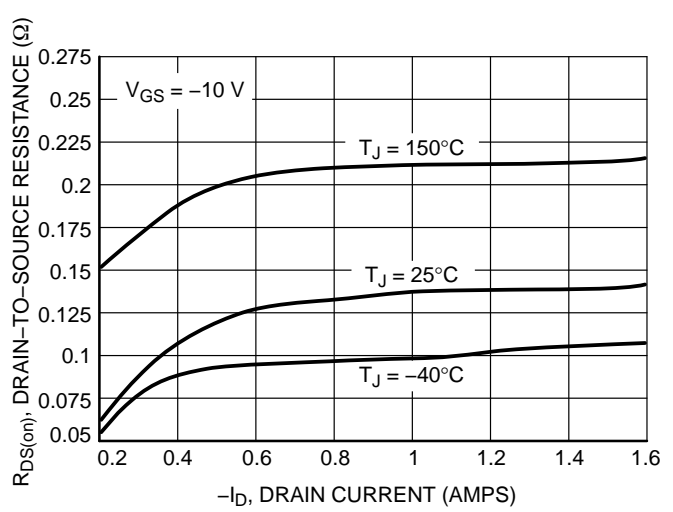

Figure 4. On-Resistance versus Drain Current and Temperature

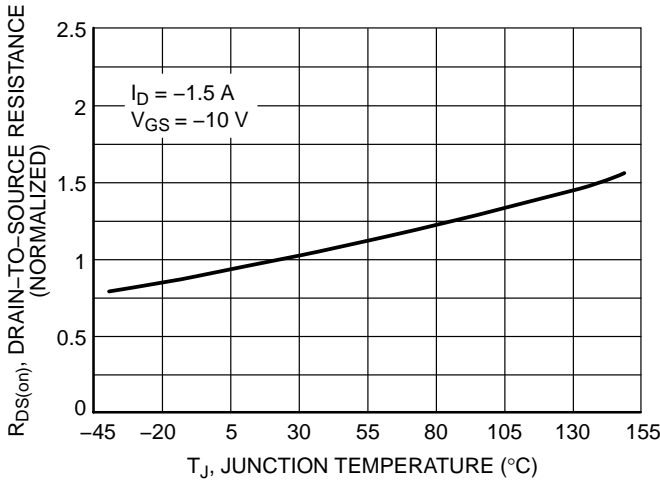

Figure 5. On-Resistance Variation with Temperature

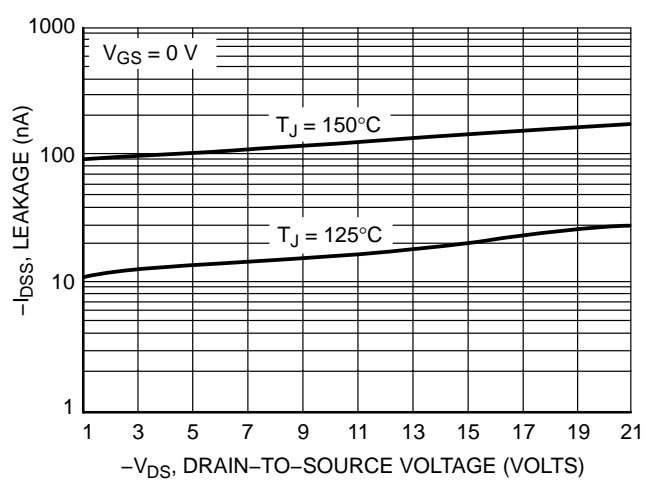
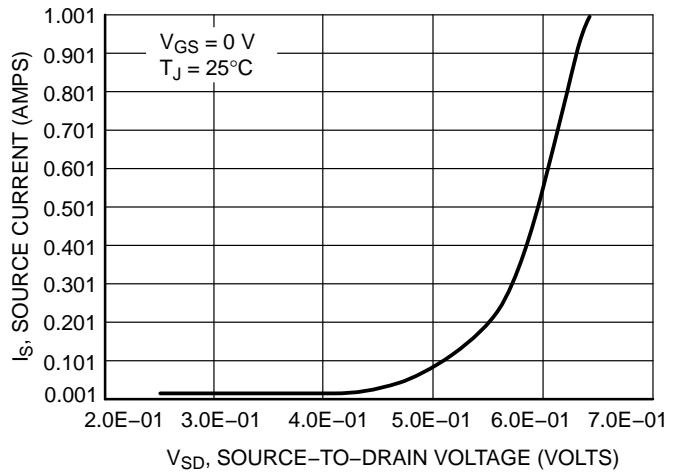
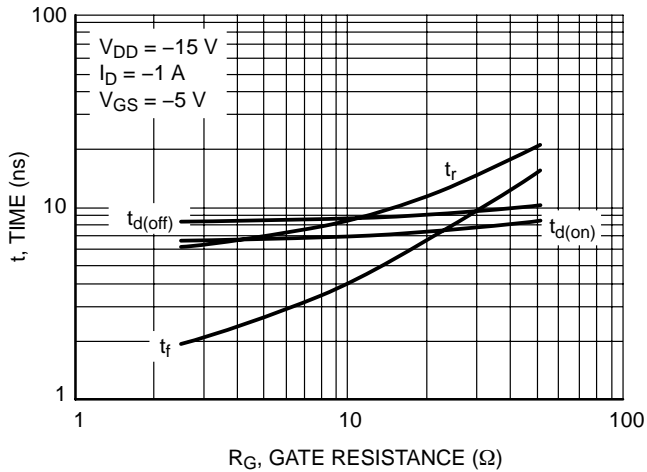
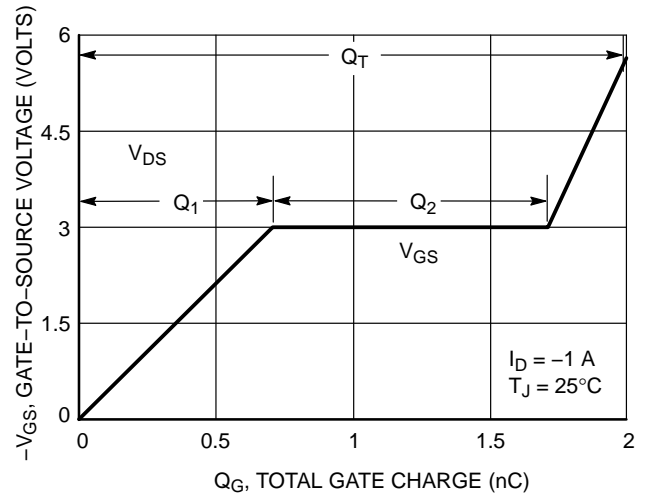
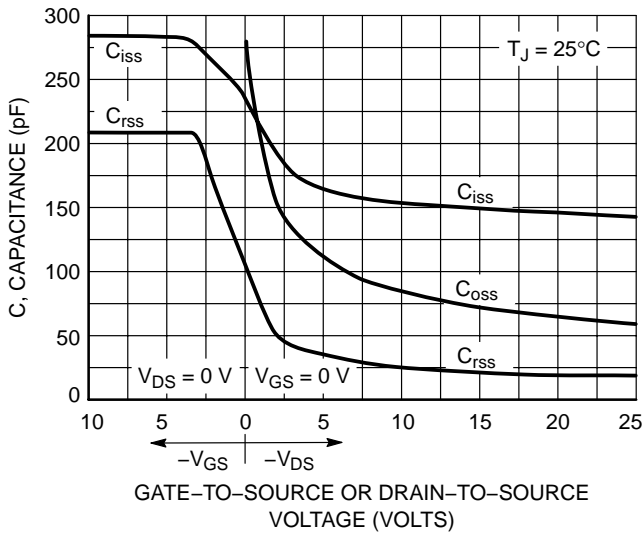

Figure 6. Drain-to-Source Leakage Current versus Voltage

NTR1P02T1



NTR1P02T1

PACKAGE DIMENSIONS

**SOT-23
(TO-236)**
CASE 318-08
ISSUE AK

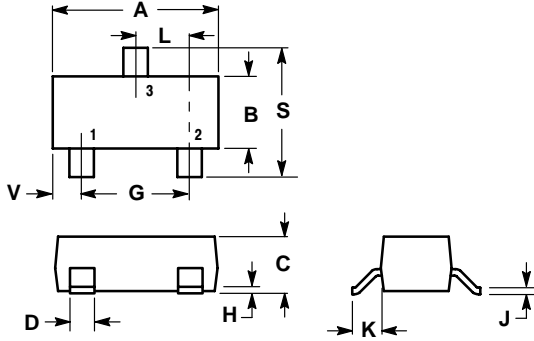

NOTES:

1. DIMENSIONING AND TOLERANCING PER ANSI Y14.5M, 1982.
2. CONTROLLING DIMENSION: INCH.
3. MAXIMUM LEAD THICKNESS INCLUDES LEAD FINISH THICKNESS. MINIMUM LEAD THICKNESS IS THE MINIMUM THICKNESS OF BASE MATERIAL.
4. 318-01 THRU -07 AND -09 OBSOLETE, NEW STANDARD 318-08.

DIM	INCHES		MILLIMETERS	
	MIN	MAX	MIN	MAX
A	0.1102	0.1197	2.80	3.04
B	0.0472	0.0551	1.20	1.40
C	0.0350	0.0440	0.89	1.11
D	0.0150	0.0200	0.37	0.50
G	0.0701	0.0807	1.78	2.04
H	0.0005	0.0040	0.013	0.100
J	0.0034	0.0070	0.085	0.177
K	0.0140	0.0285	0.35	0.69
L	0.0350	0.0401	0.89	1.02
S	0.0830	0.1039	2.10	2.64
V	0.0177	0.0236	0.45	0.60

STYLE 21:

- PIN 1. GATE
2. SOURCE
3. DRAIN

SOLDERING FOOTPRINT

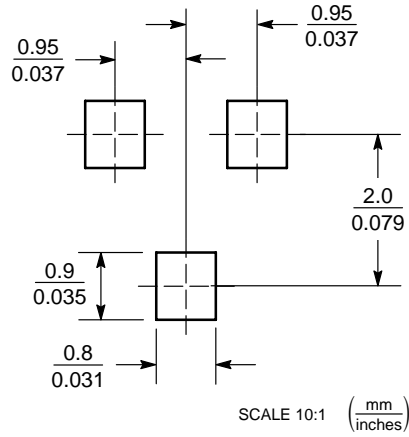

ON Semiconductor and  are registered trademarks of Semiconductor Components Industries, LLC (SCILLC). SCILLC reserves the right to make changes without further notice to any products herein. SCILLC makes no warranty, representation or guarantee regarding the suitability of its products for any particular purpose, nor does SCILLC assume any liability arising out of the application or use of any product or circuit, and specifically disclaims any and all liability, including without limitation special, consequential or incidental damages. "Typical" parameters which may be provided in SCILLC data sheets and/or specifications can and do vary in different applications and actual performance may vary over time. All operating parameters, including "Typicals" must be validated for each customer application by customer's technical experts. SCILLC does not convey any license under its patent rights nor the rights of others. SCILLC products are not designed, intended, or authorized for use as components in systems intended for surgical implant into the body, or other applications intended to support or sustain life, or for any other application in which the failure of the SCILLC product could create a situation where personal injury or death may occur. Should Buyer purchase or use SCILLC products for any such unintended or unauthorized application, Buyer shall indemnify and hold SCILLC and its officers, employees, subsidiaries, affiliates, and distributors harmless against all claims, costs, damages, and expenses, and reasonable attorney fees arising out of, directly or indirectly, any claim of personal injury or death associated with such unintended or unauthorized use, even if such claim alleges that SCILLC was negligent regarding the design or manufacture of the part. SCILLC is an Equal Opportunity/Affirmative Action Employer. This literature is subject to all applicable copyright laws and is not for resale in any manner.

PUBLICATION ORDERING INFORMATION

LITERATURE FULFILLMENT:

Literature Distribution Center for ON Semiconductor
P.O. Box 61312, Phoenix, Arizona 85082-1312 USA

Phone: 480-829-7710 or 800-344-3860 Toll Free USA/Canada

Fax: 480-829-7709 or 800-344-3867 Toll Free USA/Canada

Email: orderlit@onsemi.com

N. American Technical Support: 800-282-9855 Toll Free
USA/Canada

Japan: ON Semiconductor, Japan Customer Focus Center
2-9-1 Kamimeguro, Meguro-ku, Tokyo, Japan 153-0051
Phone: 81-3-5773-3850

ON Semiconductor Website: <http://onsemi.com>

Order Literature: <http://www.onsemi.com/litorder>

For additional information, please contact your
local Sales Representative.