



SRS WOW AUDIO PROCESSOR

■GENERAL DESCRIPTION

The **NJM2195** is a SRS WOW audio processor, based on the technology of SRS Labs, Inc.

It includes SRS 3D Stereo regenerating 3D surround sound with stereo input, TruBass providing rich bass sound and FOCUS improving sound orientation.

The **NJM2195** is suitable for audio application such as TV, CD radio-cassette, Car Audio, speaker system for PC and others.

■FEATURES

- Operating Voltage 4.7 to 13V
- WOW Function
- Punch Control for TruBass effect
- LF Elevation Control for FOCUS effect
- Width Control for SRS 3D Stereo effect
- Bypass Function (Through)
- Internal Mode Switch
- Bipolar Technology
- Package Outline SDIP42, SOP40, QFP48

■PACKAGE OUTLINE



NJM2195L

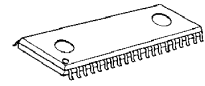

NJM2195GK1



NJM2195FJ1

The WOW technology right incorporated in the **NJM2195** are owned by SRS Labs, a U.S. Corporation and licensed to New Japan Radio Co., Ltd. Purchaser of **NJM2195** must sign a license for use of the chip and display of the SRS Labs trademarks. Any products incorporating the **NJM2195** must be sent to SRS Labs for review. WOW is protected under U.S. and foreign patents issued and/or pending. WOW, SRS and the  symbol are trademarks of SRS Labs, Inc. in the United States and selected foreign countries. Neither the purchase of the **NJM2195**, nor the corresponding sale of audio enhancement equipment conveys the right to sell commercialized recordings made with any SRS technology.

SRS Labs requires all set makers to comply with all rules and regulations as outlined in the SRS Trademark Usage Manual separately provided.

For further information, please contact:

SRS Labs, Inc.
2909 Daimler Street. Santa Ana, CA 92705 USA
Tel: 949-442-1070 Fax: 949-852-1099 <http://www.srslabs.com>

NJM2195

■PIN FUNCTION (SDIP42)

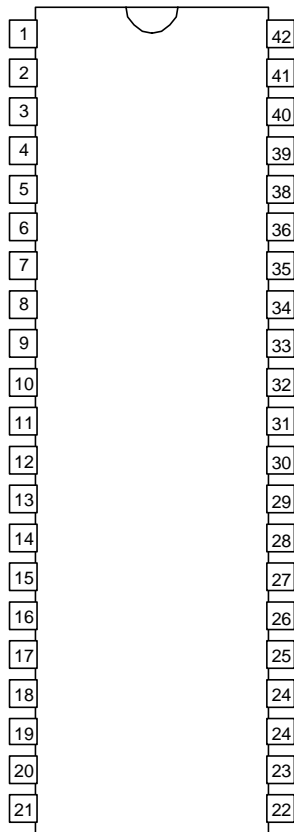

- | | | |
|-----------|------------|-------------|
| 1. C3 | 15. C2 | 29. BASSOUT |
| 2. C4 | 16. SFIL1 | 30. OUTR |
| 3. FILOUT | 17. SFIL2 | 31. OUTL |
| 4. FIL1 | 18. SFIL3 | 32. NC |
| 5. FIL2 | 19. SVOL2 | 33. TP2 |
| 6. FIL3 | 20. SVOL1 | 34. FFR3 |
| 7. FIL4 | 21. GND | 35. FFR2 |
| 8. FIL5 | 22. V+ | 36. FFR1 |
| 9. FIL6 | 23. VREFIN | 37. TP3 |
| 10. FIL7 | 24. VREF | 38. FFL3 |
| 11. NC | 25. MODE3 | 39. FFL2 |
| 12. PCOUT | 26. MODE2 | 40. FFL1 |
| 13. PCIN | 27. MODE1 | 41. INR |
| 14. C1 | 28. TP1 | 42. INL |

■PIN FUNCTION (SOP40)



- | | | |
|-----------|-------------|----------|
| 1. C3 | 15. SFIL1 | 29. OUTR |
| 2. C4 | 16. SFIL2 | 30. OUTL |
| 3. FILOUT | 17. SFIL3 | 31. TP2 |
| 4. FIL1 | 18. SVOL2 | 32. FFR3 |
| 5. FIL2 | 19. SVOL1 | 33. FFR2 |
| 6. FIL3 | 20. GND | 34. FFR1 |
| 7. FIL4 | 21. V+ | 35. TP3 |
| 8. FIL5 | 22. VREFIN | 36. FFL3 |
| 9. FIL6 | 23. VREF | 37. FFL2 |
| 10. FIL7 | 24. MODE3 | 38. FFL1 |
| 11. PCOUT | 25. MODE2 | 39. INR |
| 12. PCIN | 26. MODE1 | 40. INL |
| 13. C1 | 27. TP1 | |
| 14. C2 | 28. BASSOUT | |

■PIN FUNCTION (QFP48)

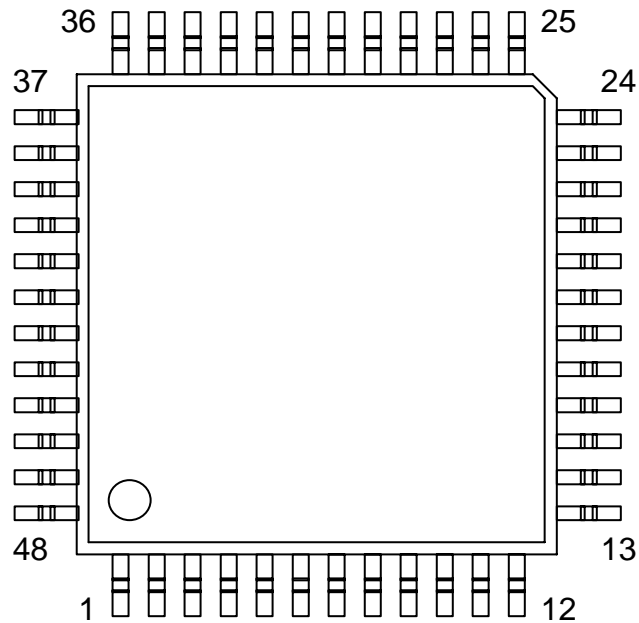

1. NC	17. SVOL1	33. FFR2
2. FIL3	18. GND	34. FFR1
3. FIL4	19. V+	35. TP3
4. FIL5	20. VREFIN	36. NC
5. FIL6	21. VREF	37. NC
6. FIL7	22. MODE3	38. FFL3
7. PCOUT	23. MODE2	39. FFL2
8. PCIN	24. NC	40. FFL1
9. C1	25. NC	41. INR
10. C2	26. MODE1	42. INL
11. SFIL1	27. TP1	43. C3
12. NC	28. BASSOUT	44. C4
13. NC	29. OUTR	45. FILOUT
14. SFIL2	30. OUTL	46. FIL1
15. SFIL3	31. TP2	47. FIL2
16. SVOL2	32. FFR3	48. NC

NJM2195

■BLOCK DIAGRAM (SDIP42)

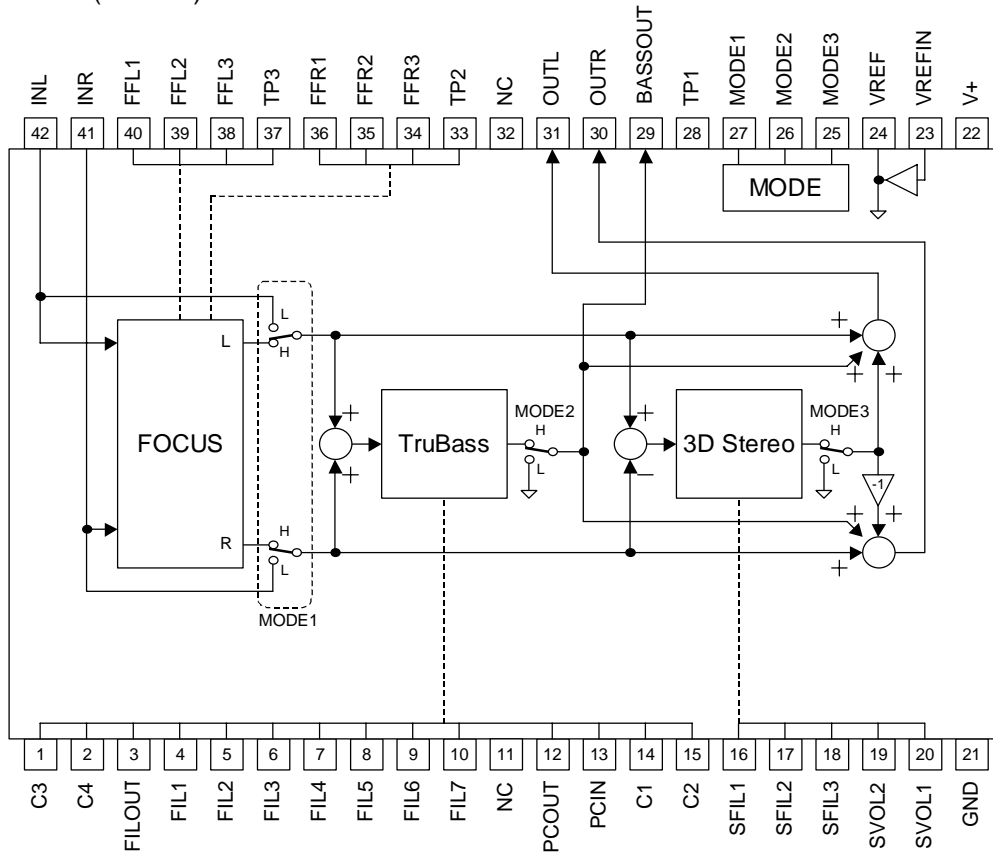

■BLOCK DIAGRAM (SOP40)

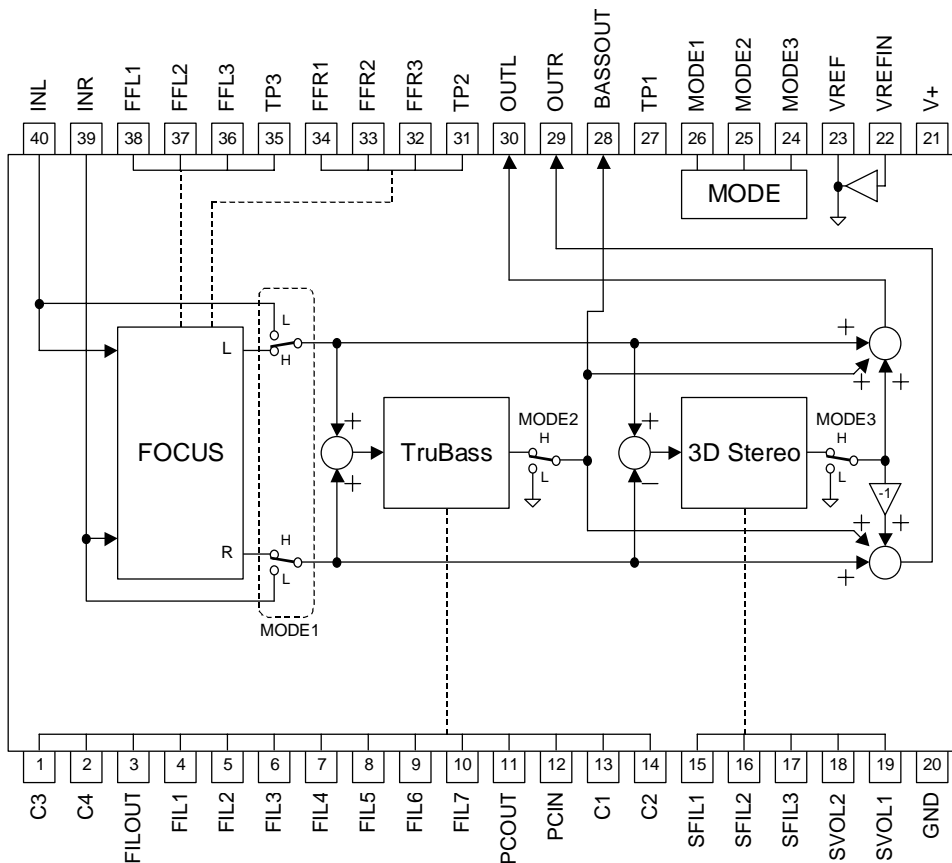

■BLOCK DIAGRAM (QFP48)

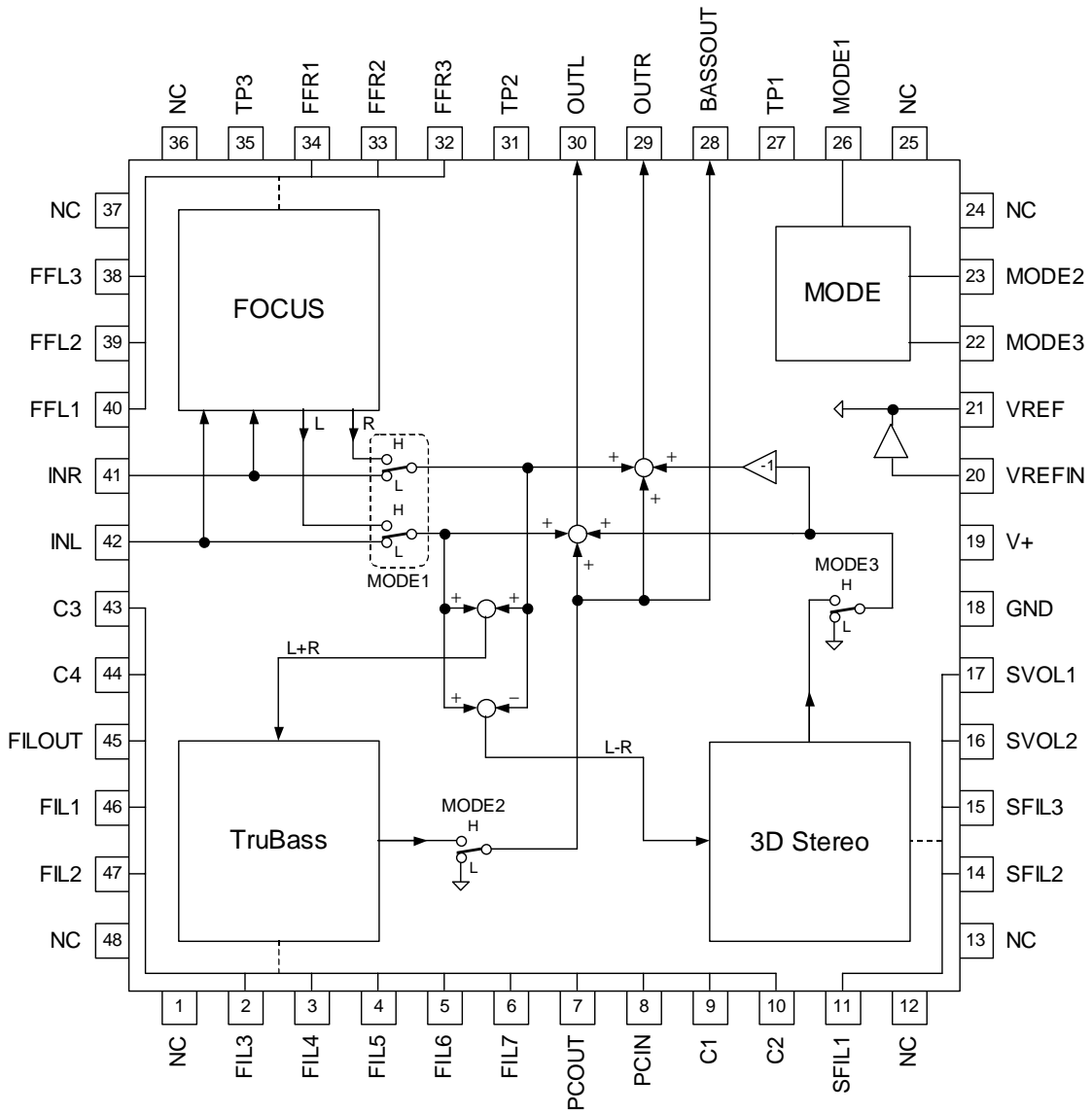

NJM2195

■ABSOLUTE MAXIMUM RATING (Ta=25°C)

PARAMETER	SYMBOL	RATING	UNIT
Supply Voltage	V ⁺	15	V
Power Dissipation	P _D	(SDIP) 700 (SOP) 700 (QFP) 450	mW
Operating Temperature Range	T _{opr}	-40 to+85	°C
Storage Temperature Range	T _{stg}	-40 to +125	°C

■ELECTRICAL CHARACTERISTICS (V⁺=12V, Ta=25°C, V_{IN}=-20dBV (=0.1Vrms), Speaker Size :Medium)

PARAMETER	SYMBOL	TEST CONDITION								MIN	TYP	MAX	UNIT		
		INPUT		OUT PUT	MODE	PUNCH VR	WIDTH VR	LF VR	MIN					TYP	MAX
		L	R												
Operating Voltage	V ⁺	-	-	-	-	-	-	-	-	4.7	12.0	13.0	V		
Operating Current	I _{CC}	No Signal	-	-	-	BYPASS	-	-	-	8.7	17.4	26.1	mA		
			-	-	-	WOW	-	-	-	8.7	17.4	26.1			
Reference Voltage	V _{REF}	V ⁺ /2	-	-	-	-	-	-	-	5.8	6.0	6.2	V		
Maximum Input Voltage	V _{IM}	f=1kHz THD=3%	V _{IN} -	- V _{IN}	L R	BYPASS	-	-	-	10.0 (32)	12.0 (40)	-	dBV (Vrms)		
		f=100Hz THD=3%	V _{IN} V _{IN}	V _{IN} V _{IN}	L R	TruBass	MAX	-	-	-	-2.7 (0.73)	-			
		f=125Hz THD=3%	V _{IN} -	- V _{IN}	L R	3D- STEREO	-	MAX	-	-	0.5 (1.1)	-			
		f=125Hz THD=3%	V _{IN} V _{IN}	-V _{IN} -V _{IN}	L R	3D- STEREO	-	MAX	-	-	-5.5 (0.53)	-			
		f=10kHz THD=3%	V _{IN} -	- V _{IN}	L R	FOCUS	-	-	MAX	-	-0.8 (0.91)	-			
		f=10kHz THD=3%	V _{IN} -	- V _{IN}	L R	WOW	MAX	MAX	MAX	-12.0 (0.25)	-10.0 (0.32)	-			
		f=100Hz THD=3%	V _{IN} V _{IN}	V _{IN} V _{IN}	L R	WOW	MAX	MAX	MAX	-5.0 (0.56)	-3.0 (0.71)	-			
		f=10kHz THD=3%	V _{IN} V _{IN}	-V _{IN} -V _{IN}	L R	WOW	MAX	MAX	MAX	-17.0 (0.14)	-15.0 (0.18)	-			
Output Noise	V _{No}	Rg=0Ω A-Weighted	0	0	L R	BYPASS	-	-	-	-	-110 (3)	-100 (10)	dBV (μVrms)		
		Rg=0Ω A-Weighted	0	0	L R	TruBass	MAX	-	-	-	-80 (100)	-			
		Rg=0Ω A-Weighted	0	0	L R	3D- STEREO	-	MAX	-	-	-95 (18)	-			
		Rg=0Ω A-Weighted	0	0	L R	FOCUS	-	-	MAX	-	-92 (25)	-			
		Rg=0Ω A-Weighted	0	0	L R	WOW	MAX	MAX	MAX	-	-75 (180)	-69 (350)			

■ELECTRICAL CHARACTERISTICS ($V^+=12V$, $T_a=25^\circ C$, $V_{IN}=-20dBV$ ($=0.1V_{rms}$), Speaker Size :Medium)

PARAMETER	SYMBOL	TEST CONDITION								MIN	TYP	MAX	UNIT
		INPUT		OUT PUT	MODE	PUNCH VR	WIDTH VR	LF VR					
		L	R										
Total Harmonic Distortion	THD	f=1kHz	V_{IN} -	- V_{IN}	L R	BYPASS	-	-	-	-	0.005	0.01	%
		f=100Hz	V_{IN} V_{IN}	V_{IN} V_{IN}	L R	TruBass	MAX	-	-	-	0.1	-	
		f=1kHz	V_{IN} -	- V_{IN}	L R	3D-STEREO	-	MAX	-	-	0.1	-	
		f=1kHz	V_{IN} -	- V_{IN}	L R	FOCUS	-	-	MAX	-	0.1	-	
		f=1kHz	V_{IN} -	- V_{IN}	L R	WOW	MAX	MAX	MAX	-	0.1	1.0	
BYPASS Gain	G_{VBYP}	f=1kHz	V_{IN} -	- V_{IN}	L R	BYPASS	-	-	-	-1.0	0.0	1.0	dB
SRS Gain	G_{SRS}	f=100Hz	V_{IN} V_{IN}	V_{IN} V_{IN}	L R	TruBass	MAX	-	-	12.8	14.8	16.8	dB
		f=100Hz	V_{IN} V_{IN}	V_{IN} V_{IN}	L R	TruBass	MIN	-	-	-2.3	1.7	5.7	
		f=125Hz	V_{IN} -	- V_{IN}	L R	3D-STEREO	-	MAX	-	9.4	11.4	13.4	
		f=125Hz	V_{IN} -	- V_{IN}	L R	3D-STEREO	-	MIN	-	-1.5	0.5	2.5	
		f=10kHz	V_{IN} -	- V_{IN}	L R	FOCUS	-	-	MAX	10.7	12.7	14.7	
		f=100Hz	V_{IN} -	- V_{IN}	L R	WOW	MAX	MAX	MAX	13.8	15.8	17.8	
		f=10kHz $V_{IN}=-35dBV$	V_{IN} -	- V_{IN}	L R	WOW	MAX	MAX	MAX	19.7	21.7	23.7	
MODE Select Control Voltage	V_{MODE}	V_{IN} =High Level								2.0	-	V^+	V
		V_{IN} =Low Level								0.0	-	0.7	

■MODE SELECT FUNCTION

MODE	MODE1	MODE2	MODE3
BYPASS	L	L	L
TruBass	L	H	L
3D-STEREO	L	L	H
FOCUS	H	L	L
WOW	H	H	H

NJM2195

■PIN DESCRIPTION

No.			SYMBOL	FUNCTION	EQUIVALENT CIRCUIT	NOTE
SDIP42	SOP40	QFP48				
11 32	-	1 12 13 24 25 36 37 48	NC NC NC NC NC NC NC NC	Non Connect Non Connect Non Connect Non Connect Non Connect Non Connect Non Connect Non Connect	_____	-
6 7 9 12 20 34 38	6 7 9 11 19 32 36	2 3 5 7 17 32 38	FIL3 FIL4 FIL6 PCOUT SVOL1 FFR3 FFL3	Filter Filter Filter PUNCH Control VR WIDTH Control VR Filter Filter		V+/2
8 10	8 10	4 6	FIL5 FIL7	Filter Filter		V+/2
13 1	12 1	8 43	PCIN C3	PUNCH Control VR Filter		V+/2

■PIN DESCRIPTION

No.			SYMBOL	FUNCTION	EQUIVALENT CIRCUIT	NOTE
SDIP42	SOP40	QFP48				
14	13	9	C1	Filter		0V
15	14	10	C2	Filter		0V
16 17 18	15 16 17	11 14 15	SFIL1 SFIL2 SFIL3	Filter Filter Filter		V+/2
19 2 5	18 2 5	16 44 47	SVOL2 C4 FIL2	WIDTH Control VR Filter Filter		V+/2

NJM2195

PIN DESCRIPTION

No.			SYMBOL	FUNCTION	EQUIVALENT CIRCUIT	NOTE
SDIP42	SOP40	QFP48				
21	20	18	GND	GND		0V
22	21	19	V+	Power Supply		V+
23	22	20	VREFIN	Reference Voltage Input		V+/2
24 29 30 31 36 40 3	23 28 29 30 34 38 3	21 28 29 30 34 40 45	VREF BASSOUT OUTR OUTL FFR1 FFL1 FILOUT	Reference Voltage Output TruBass Output Rch Output Lch Output Filter Filter Filter		V+/2
25 26 27	24 25 26	22 23 26	MODE3 MODE2 MODE1	Mode3 SW Mode2 SW Mode1 SW		0V

PIN DESCRIPTION

No.			SYMBOL	FUNCTION	EQUIVALENT CIRCUIT	NOTE
SDIP42	SOP40	QFP48				
28 35 39	27 33 37	27 33 39	TP1 FFR2 FFL2	Test Pin Filter Filter		V+/2
33 37	31 35	31 35	TP2 TP3	Test Pin Test Pin		-
41 42	39 40	41 42	INR INL	Rch Input Lch Input		V+/2
4	4	46	FIL1	Filter		V+/2

NJM2195

APPLICATION CIRCUIT (SDIP42)

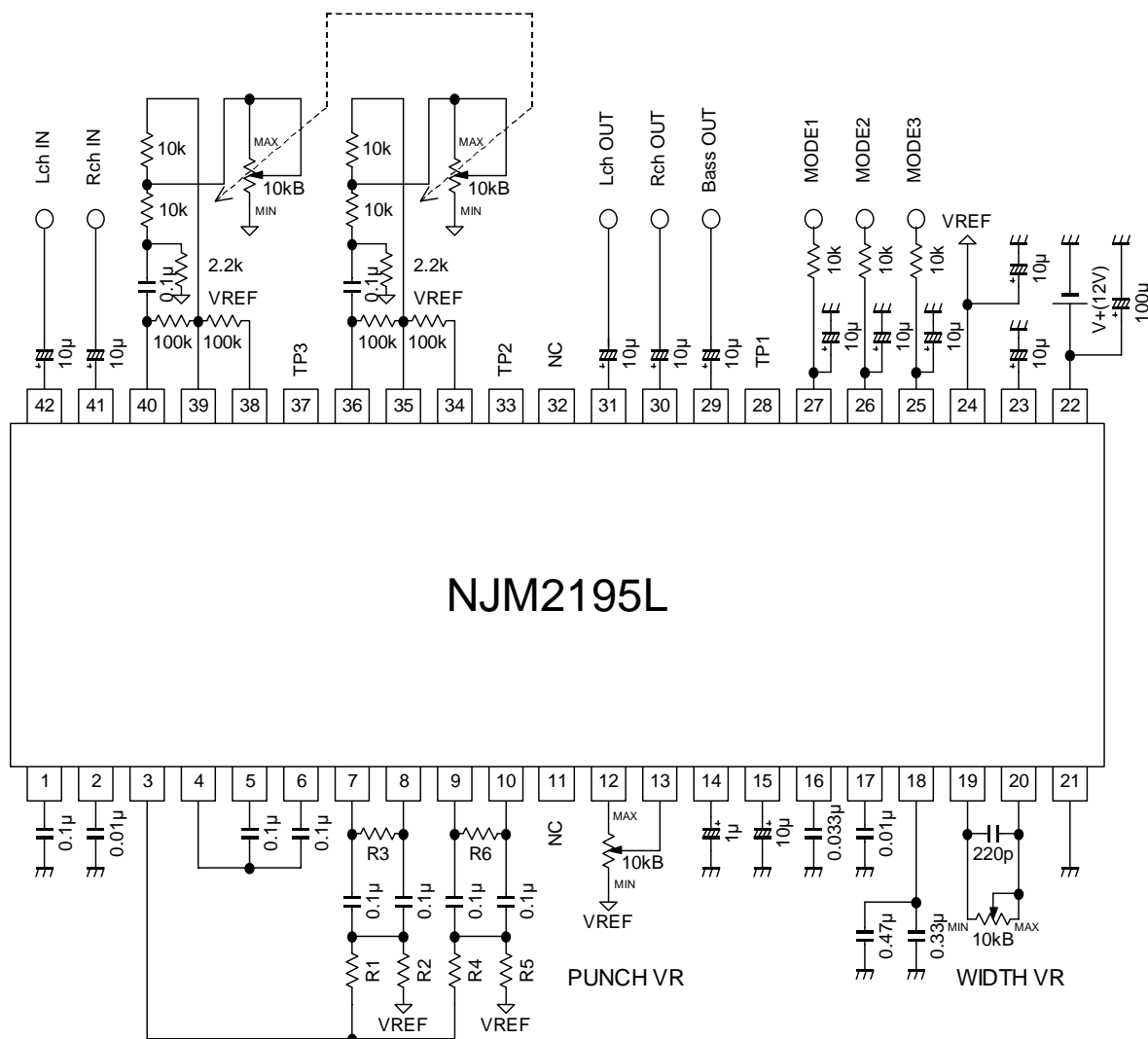

	SPEAKER SIZE		
	LARGE	MEDIUM	SMALL (TruBass mode only)
R1	56.2k	21k	21k
R2	13k	3.09k	3.09k
R3	158k	42k	42k
R4	37.4k	37.4k	22.1k
R5	8.87k	8.87k	2.32k
R6	107k	107k	32k

The standard setting of speaker size is as follows.(Reference)

- Large Mode : $f_o \leq 80\text{Hz}$
- Medium Mode : $80\text{Hz} < f_o \leq 150\text{Hz}$
- Small Mode : $150\text{Hz} < f_o \leq 250\text{Hz}$

APPLICATION CIRCUIT (SOP40)

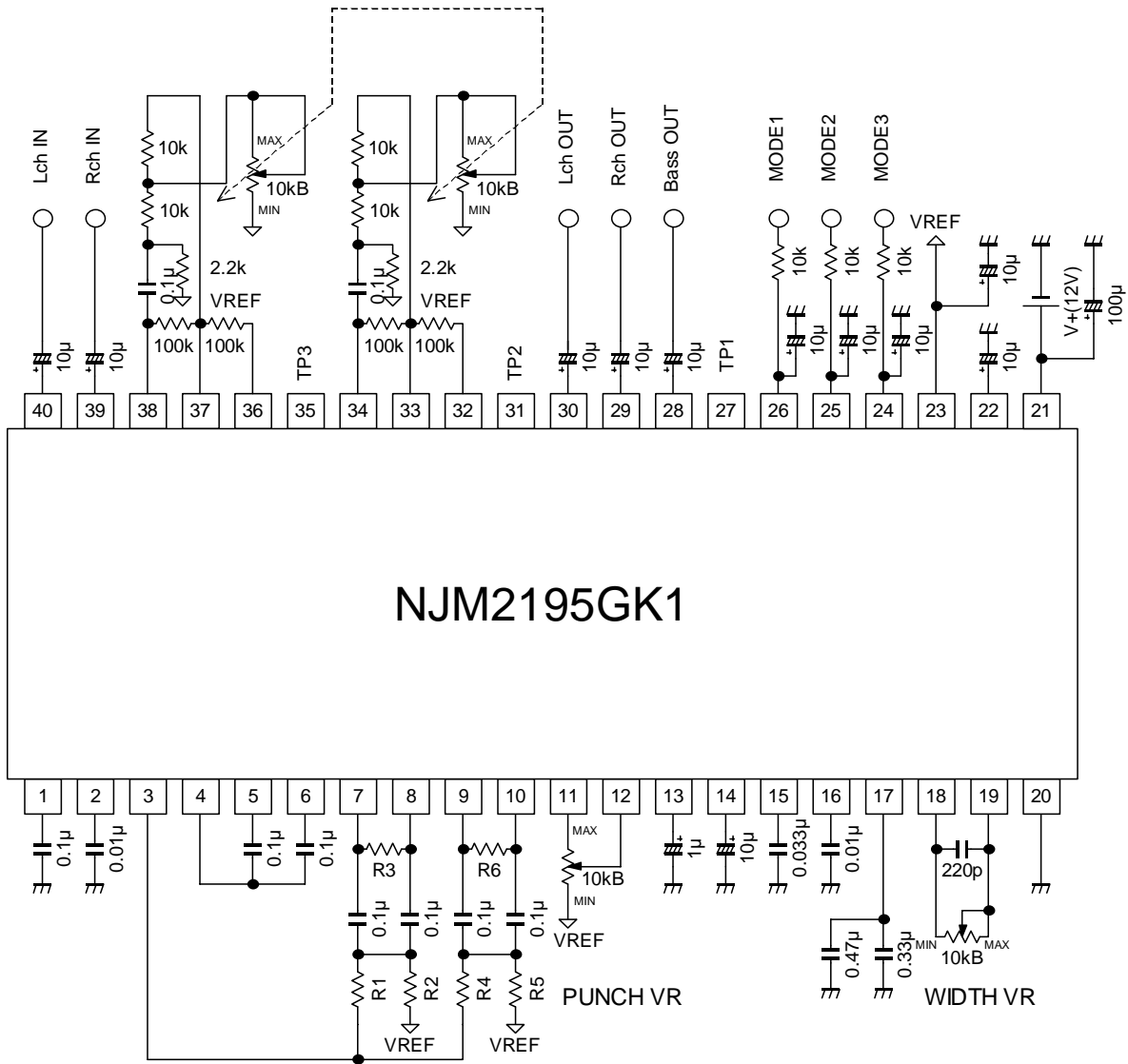

	SPEAKER SIZE		
	LARGE	MEDIUM	SMALL (TruBass mode only)
R1	56.2k	21k	21k
R2	13k	3.09k	3.09k
R3	158k	42k	42k
R4	37.4k	37.4k	22.1k
R5	8.87k	8.87k	2.32k
R6	107k	107k	32k

The standard setting of speaker size is as follows.(Reference)

- Large Mode : $f_0 \leq 80\text{Hz}$
- Medium Mode : $80\text{Hz} < f_0 \leq 150\text{Hz}$
- Small Mode : $150\text{Hz} < f_0 \leq 250\text{Hz}$

TYPICAL CHARACTERISTICS

Operating Current vs. Operating Voltage

$V_+ = 1$ to $15V$, $T_a = 25^\circ C$

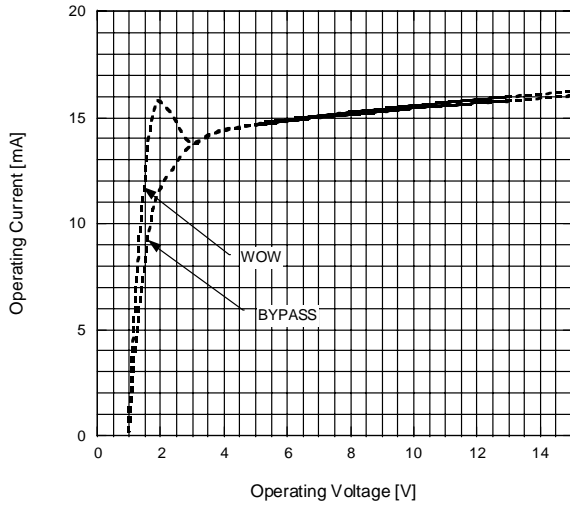

Maximum Input Voltage vs. Operating Voltage (BYPASS)

$V_{in} = Lch$, $V_{out} = Lch$, $f = 1kHz$, $R_L = 4.7k\Omega$

$R_g = 25\Omega$, $T_a = 25^\circ C$

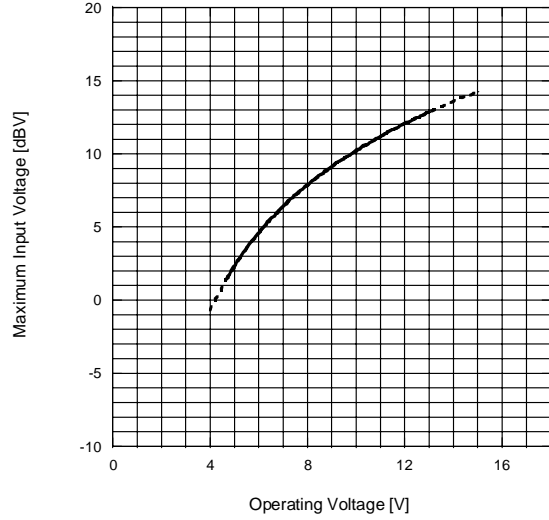

Maximum Input Voltage vs. Operating Voltage (WOW)

$V_{in} = Lch$, $V_{out} = Lch$, $f = 10kHz$, $R_L = 4.7k\Omega$

LFVR=MAX, $R_g = 25\Omega$, $T_a = 25^\circ C$

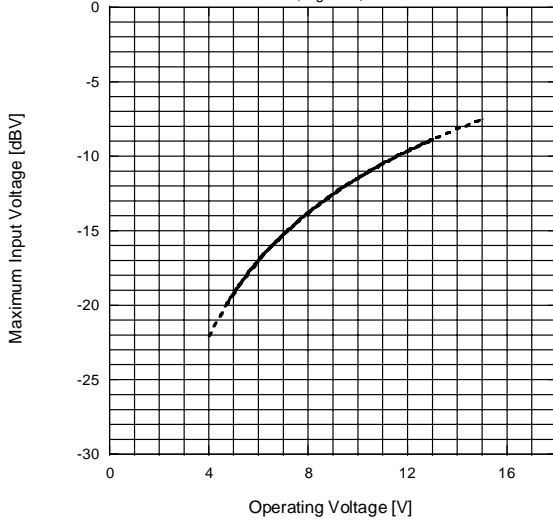

Total Harmonic Distortion vs. Input Voltage (BYPASS)

$V_+ = 12V$, $V_{in} = Lch$, $V_{out} = Lch$, $f = 1kHz$, $R_L = 4.7k\Omega$

$R_g = 25\Omega$, BW=10-80kHz

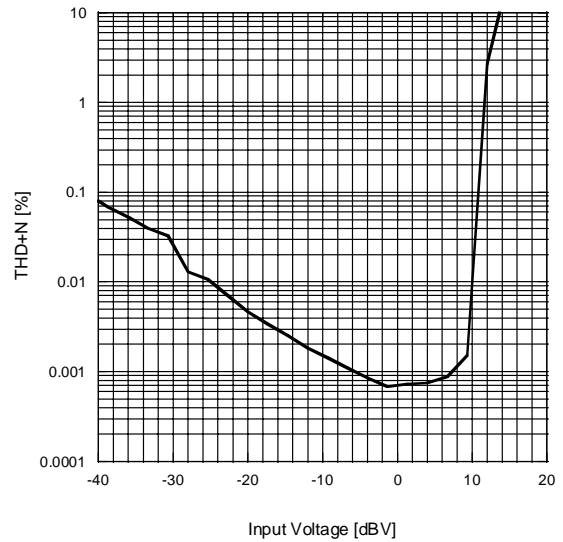

Total Harmonic Distortion (TruBass)

$V_+ = 12V$, $V_{in} = L+Rch$, $V_{out} = Lch$, $f = 100Hz$, $R_L = 4.7k\Omega$

$R_g = 25\Omega$, BW=10-80kHz

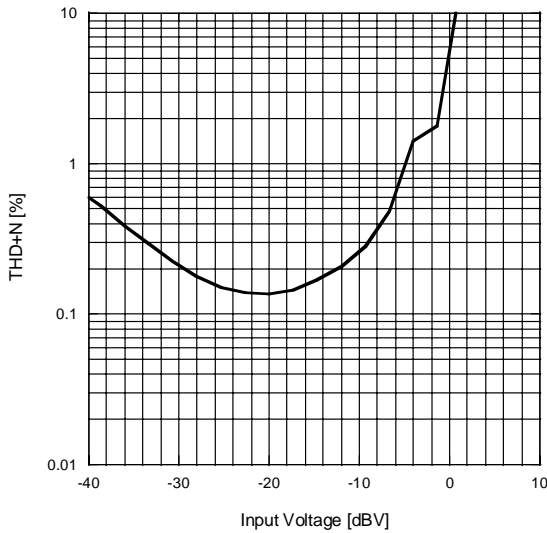

Total Harmonic Distortion vs. Input Voltage (3D Stereo)

$V_+ = 12V$, $V_{in} = Lch$, $V_{out} = Lch$, $f = 1kHz$, $R_L = 4.7k\Omega$

$R_g = 25\Omega$, BW=10-80kHz

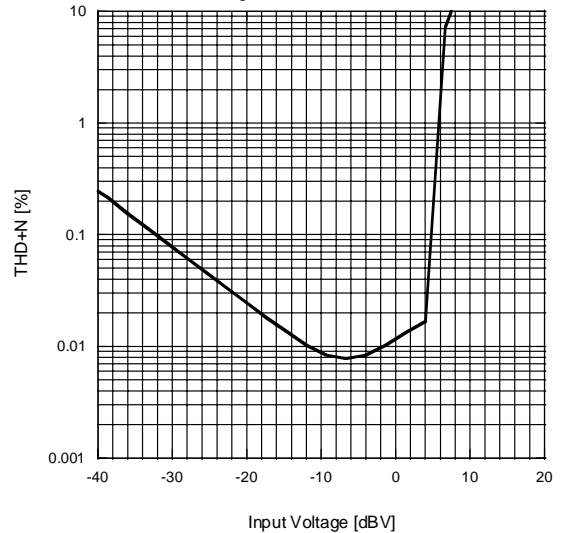

TYPICAL CHARACTERISTICS

Total Harmonic Distortion vs. Input Voltage (WOW)

$V_+ = 12V$, $V_{in} = Lch$, $V_{out} = Lch$, $f = 1kHz$, $R_L = 4.7k\Omega$
 $R_g = 25\Omega$, $BW = 10-80kHz$

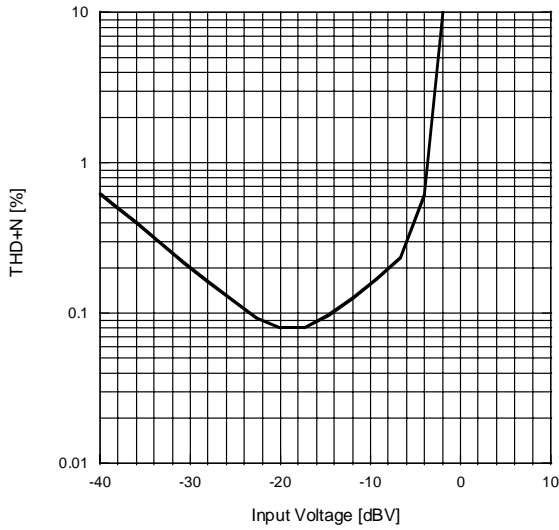

Frequency Response (BYPASS)

$V_+ = 12V$, $V_{in} = -10dBV$ Lch, $V_{out} = Lch$, $R_L = 4.7k\Omega$
 $R_g = 25\Omega$

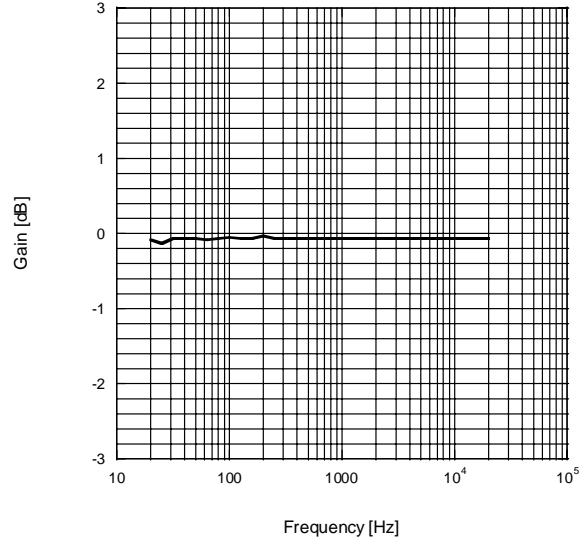

Frequency Response (TruBass)

$V_+ = 12V$, $V_{in} = -20dBV$ L+Rch, $V_{out} = Lch$, $R_L = 4.7k\Omega$
 $VR = ALLMAX$, Medium Mode, $R_g = 25\Omega$

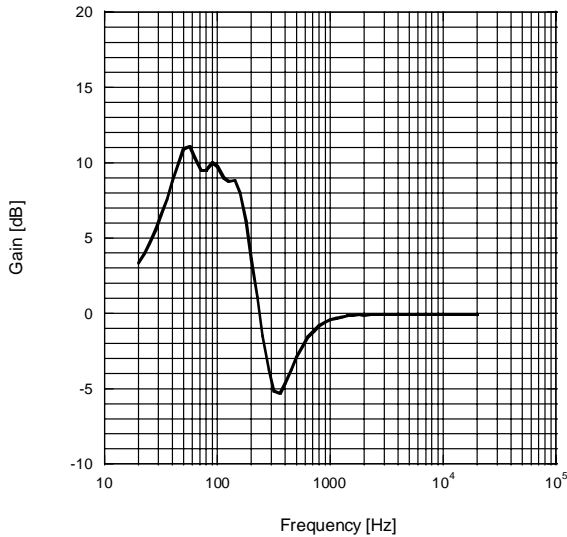

Frequency Response (3D Stereo)

$V_+ = 12V$, $V_{in} = -20dBV$ Lch, $V_{out} = L/Rch$, $R_L = 4.7k\Omega$
 $VR = ALLMAX$, $R_g = 25\Omega$

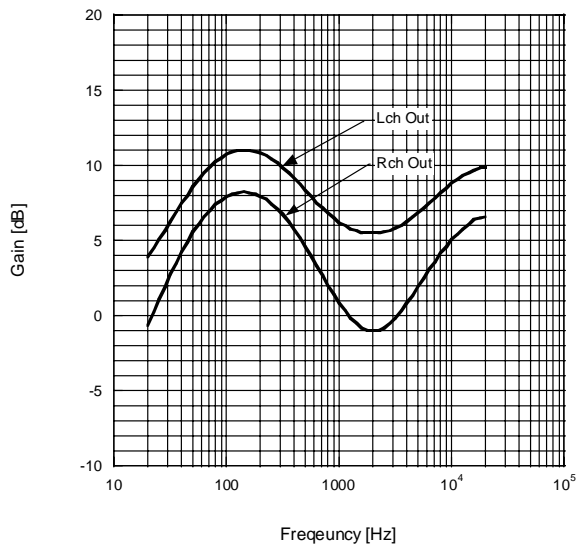

Frequency Response (FOCUS)

$V_+ = 12V$, $V_{in} = -20dBV$ Lch, $V_{out} = Lch$, $R_L = 4.7k\Omega$
 $R_g = 25\Omega$

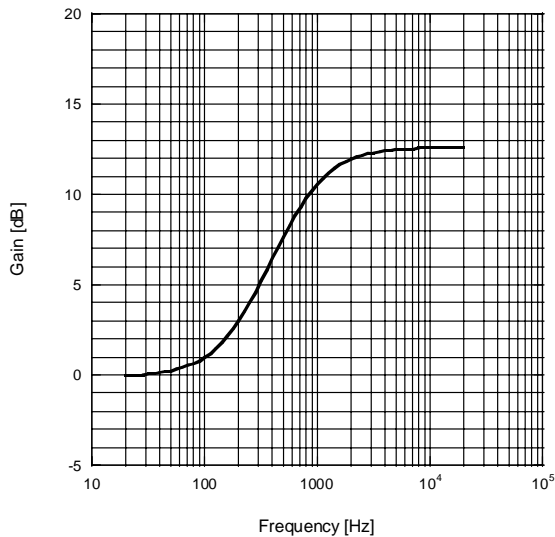

Frequency Response (WOW)

$V_+ = 12V$, $V_{in} = -20dBV$ Lch, $V_{out} = L/Rch$, $R_L = 4.7k\Omega$
 $VR = ALLMAX$, $R_g = 25\Omega$

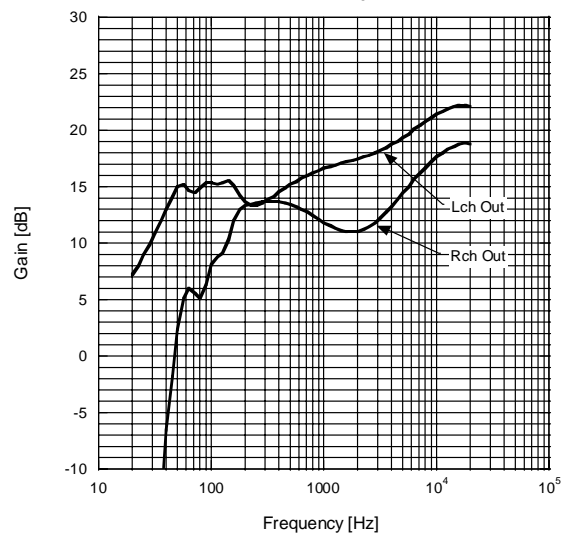

[CAUTION]

The specifications on this databook are only given for information , without any guarantee as regards either mistakes or omissions. The application circuits in this databook are described only to show representative usages of the product and not intended for the guarantee or permission of any right including the industrial rights.