

SPDT SWITCH GaAs MMIC

■GENERAL DESCRIPTION

NJG1516KC1 is a GaAs SPDT switch IC suited for antenna switch of cellular phone handset.

This switch features low loss, high isolation at high power, and exhibits wide operating frequency range from 50MHz to 3GHz at low voltage of 2.7V.

The ultra small & ultra thin FLP10-C1 package is applied.

■PACKAGE OUTLINE

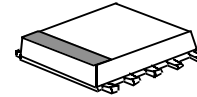

NJG1516KC1

■FEATURES

- Single low voltage control +2.7V min.
- Handling power 36dBm typ. @f=2GHz, $V_{CTL}=3.0V$
- Low insertion loss 0.4dB typ. @f=1GHz, $P_{IN}=31dBm$, $V_{CTL}=3V$
- 0.4dB typ. @f=1GHz, $P_{IN}=34.5dBm$, $V_{CTL}=3.5V$
- 0.7dB typ. @f=2GHz, $P_{IN}=31.5dBm$, $V_{CTL}=3V$
- High isolation 27dB typ. @f=1GHz, $P_{IN}=34.5dBm$, $V_{CTL}=3.0V$
- 25dB typ. @f=2GHz, $P_{IN}=31.5dBm$, $V_{CTL}=3.0V$
- Low current consumption 38uA typ. @f=2GHz, $P_{IN}=34.5dBm$, $V_{CTL}=3.0V$
- Very small package FLP10-C1 (Package size: 3.0x2.8x0.75mm)

■PIN CONFIGURATION

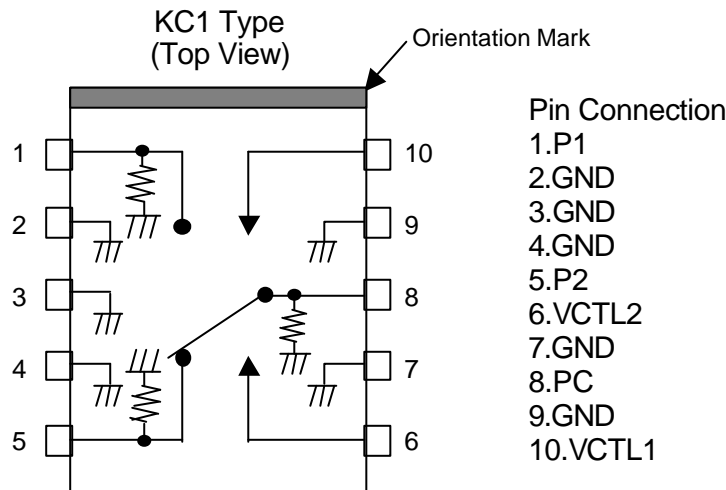

■TRUTH TABLE

“H”= V_{CTL} (H), “L”= V_{CTL} (L)

V_{CTL1}	H	L
V_{CTL2}	L	H
PC - P1	ON	OFF
PC - P2	OFF	ON

NJG1516KC1

■ABSOLUTE MAXIMUM RATINGS

(T_a=25°C)

PARAMETER	SYMBOL	CONDITIONS	RATINGS	UNITS
Input Power	P _{IN}	V _{CTL(L)} =0V, V _{CTL(H)} =3.0V	38	dBm
Control Voltage	V _{CTL}	V _{CTL(H)} -V _{CTL(L)}	12	V
Power Dissipation	P _D		500	mW
Operating Temp.	T _{opr}		-40~+85	°C
Storage Temp.	T _{stg}		-55~+125	°C

■ELECTRICAL CHARACTERISTICS

(V_{CTL(L)}=0V, V_{CTL(H)}=3V, Z_S=Z_L=50Ω, T_a=25°C)

PARAMETERS	SYMBOL	CONDITIONS	MIN	TYP	MAX	UNITS
Operating Voltage (LOW)	V _{CTL(L)}		-0.2	0	0.2	V
Operating Voltage (HIGH)	V _{CTL(H)}	f=1GHz, P _{IN} =34.5dBm	2.7	3.0	9.0	V
Control Current	I _{CTL}	f=1GHz, P _{IN} =34.5dBm	-	38	55	uA
Insertion Loss 1	LOSS1	f=1GHz, P _{IN} =31dBm	-	0.4	0.5	dB
Insertion Loss 2	LOSS2	f=1GHz, P _{IN} =34.5dBm V _{CTL(H)} =3.5V, V _{CTL(L)} =0V	-	0.4	0.5	dB
Insertion Loss 3	LOSS3	f=1GHz, P _{IN} =34.5dBm	-	0.5	0.6	dB
Insertion Loss 4	LOSS4	f=2GHz, P _{IN} =31.5dBm	-	0.7	0.8	dB
Isolation 1 (PC-P1, PC-P2)	ISL1	f=1GHz, P _{IN} =34.5dBm	26	27	-	dB
Isolation 2 (PC-P1, PC-P2)	ISL2	f=2GHz, P _{IN} =31.5dBm	22	25	-	dB
Maximum Input Power 1 *1	P _{IN1}	V _{CTL(H)} =2.7V, f=2GHz	-	-	33.5	dBm
Maximum Input Power 2 *1	P _{IN2}	V _{CTL(H)} =3V, f=2GHz	-	-	34	dBm
Maximum Input Power 3 *1	P _{IN3}	V _{CTL(H)} =4V, f=2GHz	-	-	37	dBm
Maximum Input Power 4 *1	P _{IN4}	V _{CTL(H)} =6V, f=2GHz	-	-	38	dBm
Maximum Input Power 5 *1	P _{IN5}	V _{CTL(H)} =9V, f=2GHz	-	-	34.5	dBm
Pout at 0.2dB Compression point	P _{-0.2dB1}	f=2GHz	34.5	36	-	dBm
VSWR 1 (PC, P1, P2)	VSWR	f=0.05~2.5GHz, ON State	-	1.45	1.55	
Switching Time	T _{SW}	f=0.05~2.5GHz	-	70	-	ns

*1: Maximum Input Power: This value is defined as maximum input power of linear operating region or damage free operating region.

■ ELECTRICAL CHARACTERISTICS (Cellular Band)

($V_{CTL(L)}=0V$, $V_{CTL(H)}=2.7V$, $Z_s=Z_l=50\Omega$, $T_a=25^\circ C$)

PARAMETERS	SYMBOL	CONDITIONS	MIN	TYP	MAX	UNITS
Frequency range	f_{in}		800	-	1000	MHz
Control voltage (HIGH)	$V_{CTL(H)}$	$P_{IN}=25dBm$	2.7	-	9	V
Insertion Loss 5	LOSS5	$P_{IN}=25dBm$	-	0.4	0.5	dB
Isolation 3 (PC-P1, PC-P2)	ISL3	$P_{IN}=25dBm$	26	27	-	dB
Pout at 0.2dB Compression point 2	$P_{-0.2dB(2)}$		33.5	35	-	dBm
Input 3rd Order Intercept Point 1	IIP3(1)	$f=900+901MHz$, $P_{IN}=25dBm$, $V_{CTL(H)}=3V$, $V_{CTL(L)}=0V$ *2	-	62	-	dBm
Input 3rd Order Intercept Point 2	IIP3(2)	$f=900+901MHz$, $P_{IN}=25dBm$ $V_{CTL(H)}=2.7V$, $V_{CTL(L)}=0V$ *2	-	60	-	dBm
Second Harmonics	2fo	$f=900MHz$, $P_{IN}=25dBm$ 2nd Harmonics of Input Signal = -83dBc		-80	-	dBc
Third Harmonics	3fo	$f=900MHz$, $P_{IN}=25dBm$ 3rd Harmonics of Input Signal =-100dBc	-	-70	-	dBc
VSWR 2 (PC, P1, P2)	VSWR2	ON State	-	1.15	1.25	

*2: The input IP3 is defined as following equation.

$$IIP3 = (3 \times P_{out} - IM3) / 2 + LOSS$$

NJG1516KC1

■ TERMINAL INFORMATION

No.	SYMBOL	EXPLANATION
1	P1	RF port. This port is connected with PC port by controlling 6 th pin ($V_{CTL(H)}$) to 2.7~9.0V and 4 th pin ($V_{CTL(L)}$) to -0.2~+0.2V. An external capacitor is required to block the DC bias voltage of internal circuit. (50~100MHz: 0.01 μ F, 0.1~0.5GHz: 1000pF, 0.5~2.5GHz: 56pF)
2, 3, 4, 7, 9	GND	Ground terminal. Please connect this terminal with ground plane as close as possible for excellent RF performance.
5	P2	RF port. This port is connected with PC port by controlling 4 th pin ($V_{CTL(H)}$) to 2.7~9.0V and 6 th pin ($V_{CTL(L)}$) to -0.2~+0.2V. An external capacitor is required to block the DC bias voltage of internal circuit. (50~100MHz: 0.01 μ F, 0.1~0.5GHz: 1000pF, 0.5~2.5GHz: 56pF)
6	VCTL2	Control port 2. The voltage of this port controls PC to P2 state. The 'ON' and 'OFF' state is toggled by controlling voltage of this terminal such as high-state (2.7~5.5V) or low-state (-0.2~+0.2V). The voltage of 6 th pin have to be set to opposite state. The bypass capacitor has to be chosen to reduce switching speed delay from 10pF~1000pF range.
8	PC	Common RF port. In order to block the DC bias voltage of internal circuit, an external capacitor is required. (50~100MHz: 0.01 μ F, 0.1~0.5GHz: 1000pF, 0.5~2.5GHz: 56pF)
10	VCTL1	Control port 1. The voltage of this port controls PC to P1 state. The 'ON' and 'OFF' state is toggled by controlling voltage of this terminal such as high-state (2.7~5.5V) or low-state (-0.2~+0.2V). The voltage of 4 th pin have to be set to opposite state. The bypass capacitor has to be chosen to reduce switching speed delay from 10pF~1000pF range.

■ ELECTRICAL CHARACTERISTICS

(f=50MHz~3GHz, with application circuit, losses of external circuit are excluded)

PC-P1 Insertion Loss vs. Frequency

(VCTL1=3.0V, VCTL2=0V, Pin=0dBm)

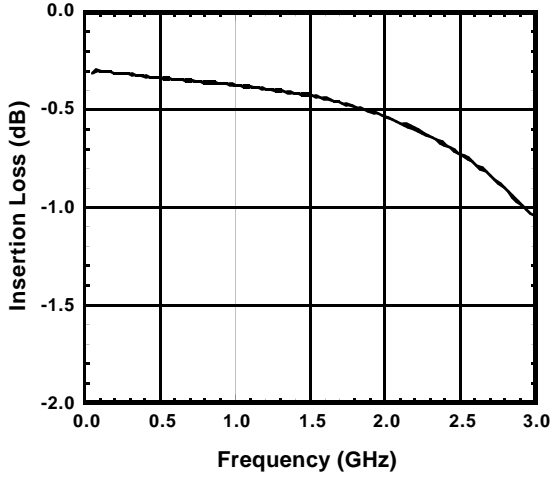

PC-P2 Insertion Loss vs. Frequency

(VCTL1=0V, VCTL2=3.0V, Pin=0dBm)

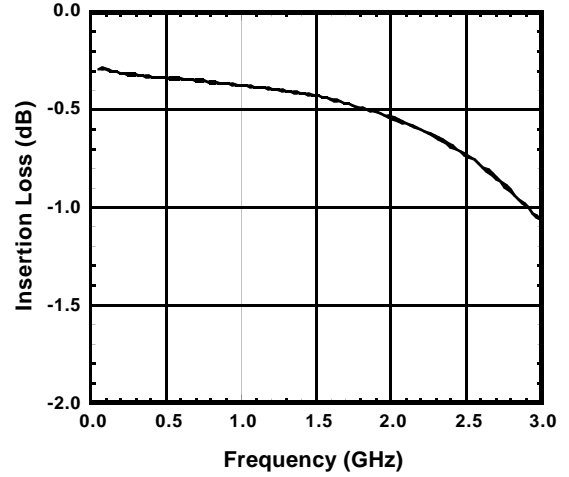

PC-P1 Isolation vs. Frequency

(VCTL1=0V, VCTL2=3V, Pin=0dBm)

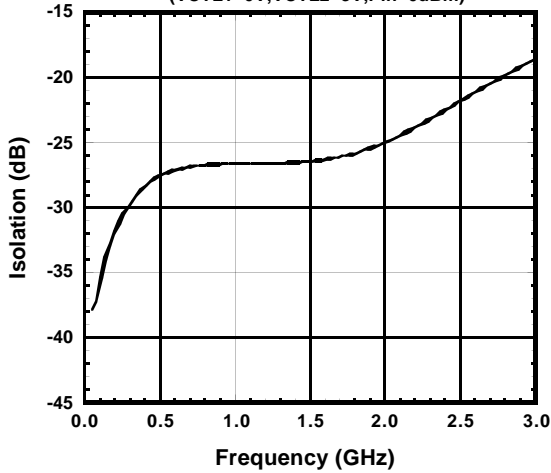

PC-P2 Isolation vs. Frequency

(VCTL1=3V, VCTL2=0V, Pin=0dBm)

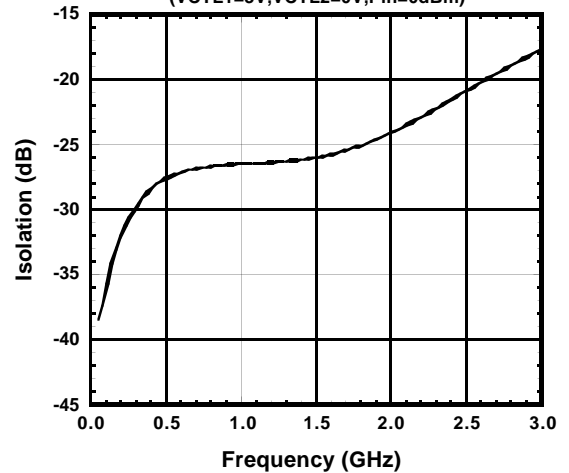

PC-P1 VSWR vs. Frequency

(VCTL1=3V, VCTL2=0V, PC port)

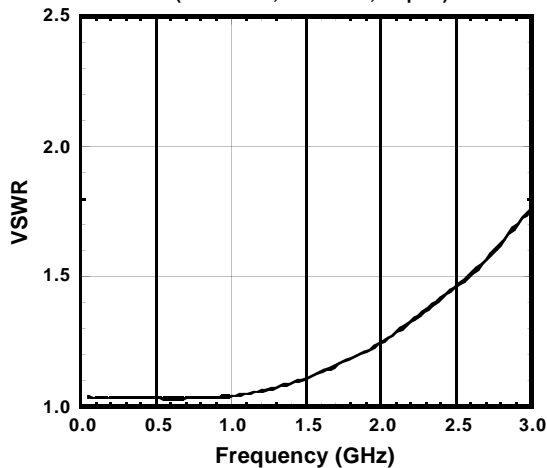

PC-P2 VSWR vs. Frequency

(VCTL1=3V, VCTL2=0V, P1 port)

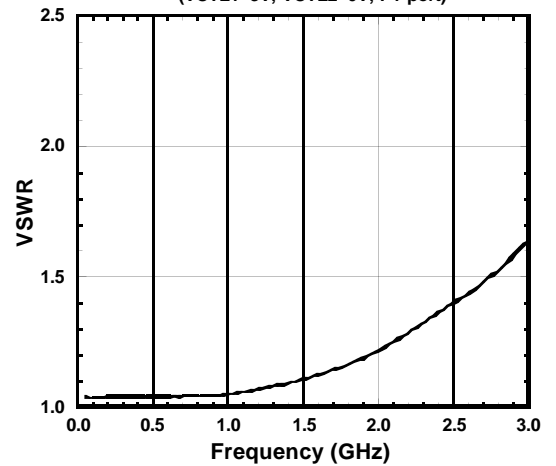

NJG1516KC1

ELECTRICAL CHARACTERISTICS

(f=1GHz, with application circuit (Parts list 3), losses of PCB, DC blocking capacitor are excluded)

Output Power, Insertion Loss vs. Input power
(PC-P1, f=1GHz)

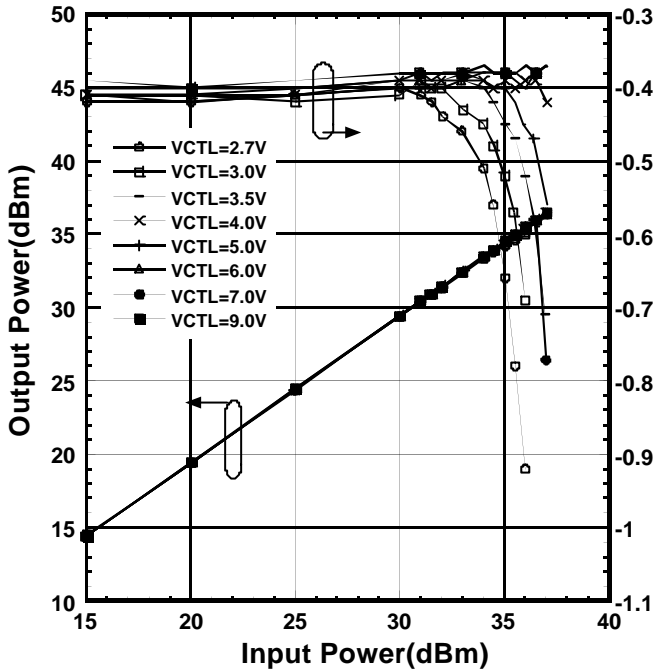

PC-P1 Isolation vs. Input Power
(PC-P1, f=1GHz)

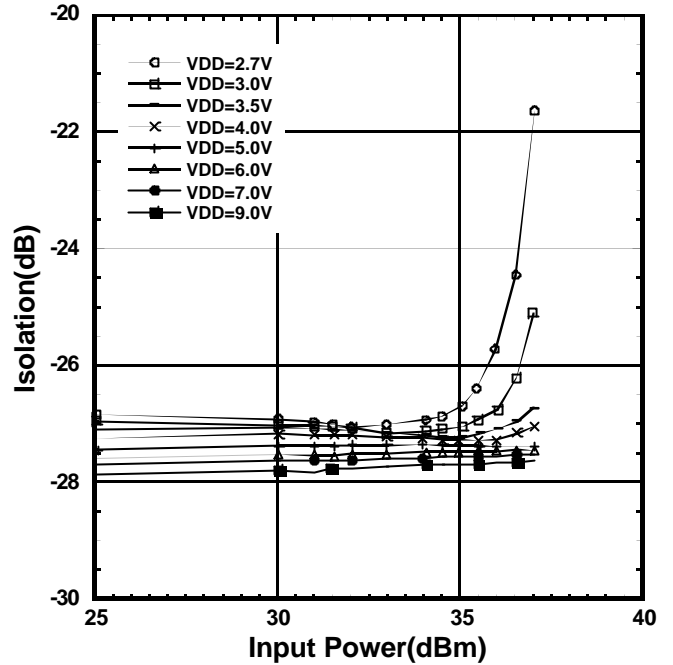

I_{CTL} vs. Input Power
(PC-P1, f=1GHz)

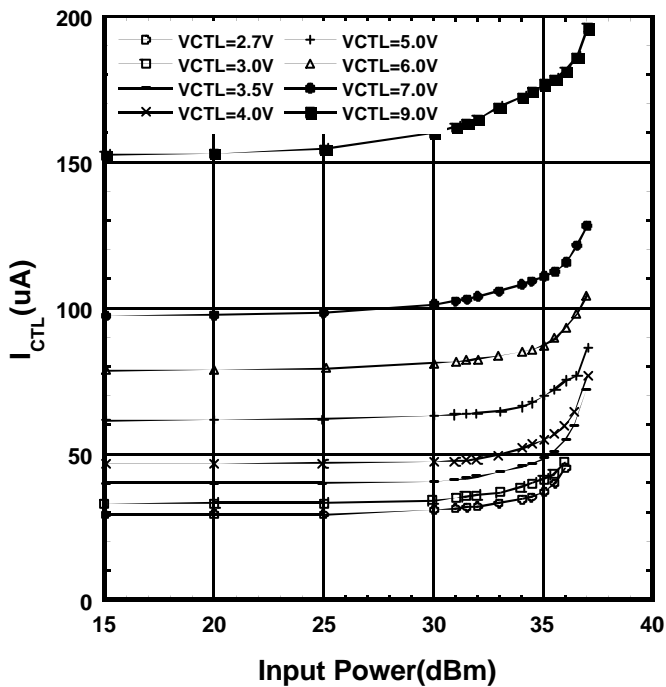

ELECTRICAL CHARACTERISTICS

(f=2GHz, with application circuit (Parts list 3), losses of PCB, connector and DC blocking capacitor are excluded)

Output Power, Insertion Loss vs. Input power
(PC-P1, f=2GHz)

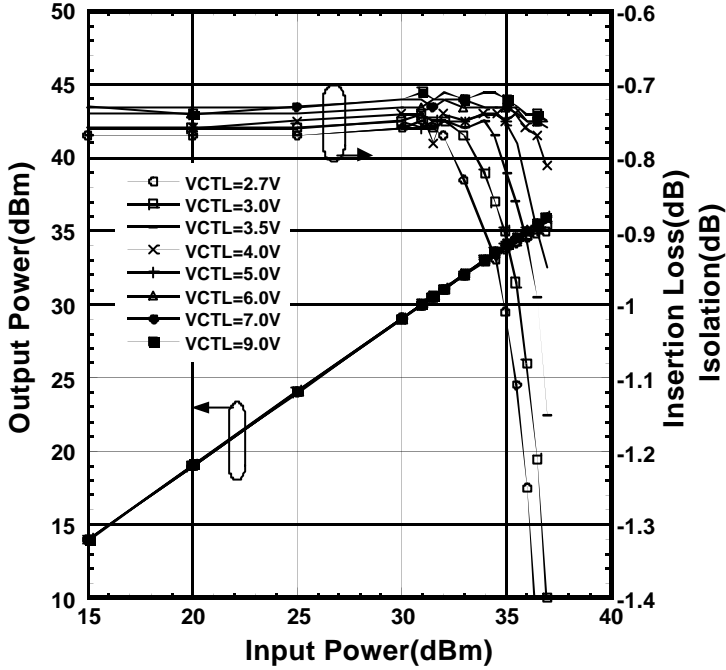

PC-P1 Isolation vs. Input Power
(PC-P1, f=2GHz)

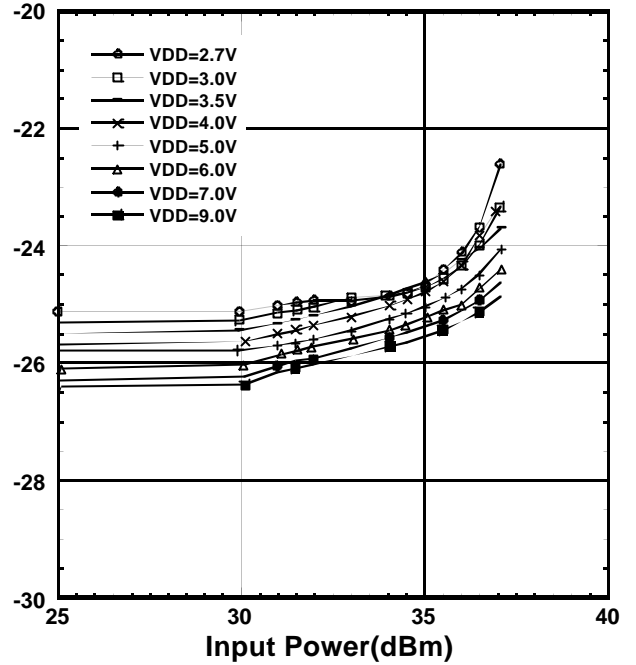

I_{CTL} vs. Input Power
(PC-P1, f=2GHz)

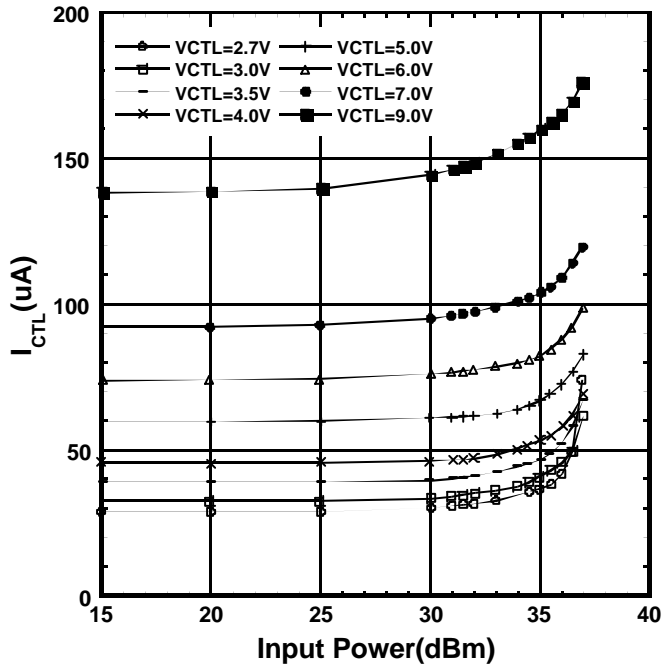

NJG1516KC1

ELECTRICAL CHARACTERISTICS (with application circuit, Parts list 3)

Switching speed
 $(V_{CTL1}=3.0V, V_{CTL2}=0V)$

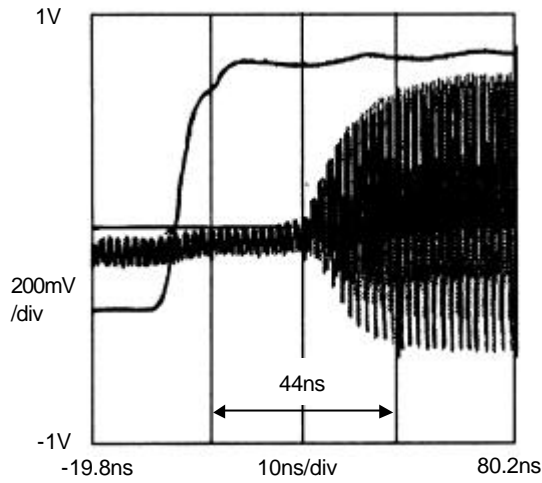

Output Power, IM3 vs. Input Power

$(V_{CTL1}=2.7V, V_{CTL2}=0V, f=900+901MHz)$

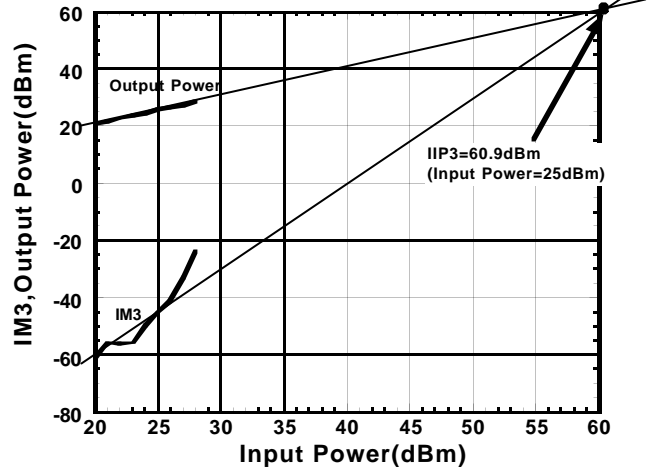

Output Power, IM3 vs. Input Power

$(V_{CTL1}=3V, V_{CTL2}=0V, f=900+901MHz)$

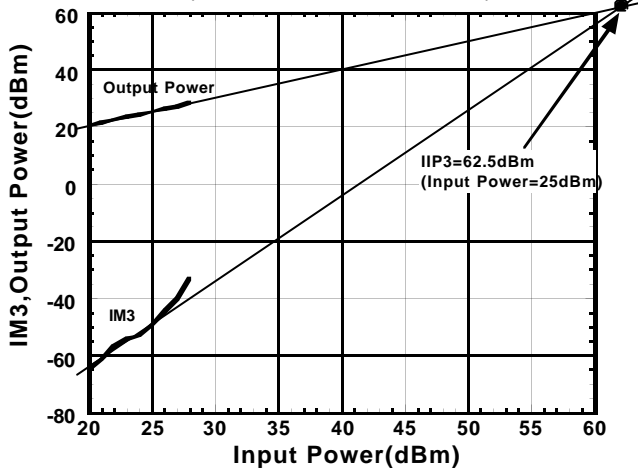

Output Power, IM3 vs. Input Power

$(V_{CTL1}=3.5V, V_{CTL2}=0V, f=900+901MHz)$

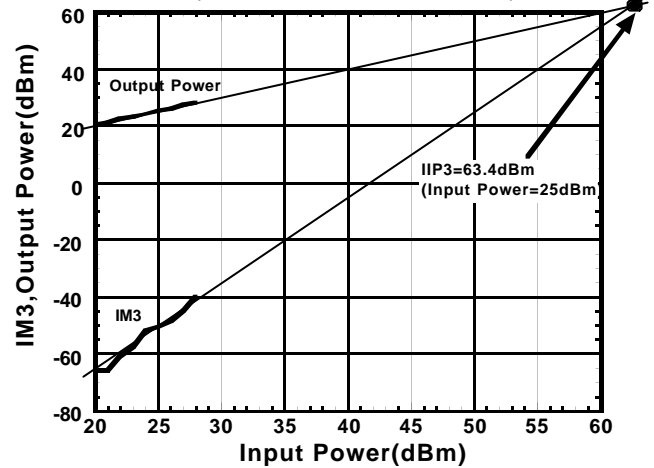

IM3 vs. Input Power

$(f=900+901MHz)$

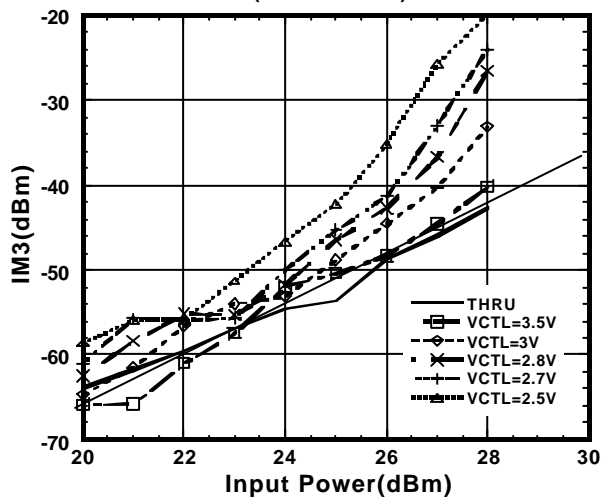

Pin-IM3 vs. Input Power

$(f=900+901MHz)$

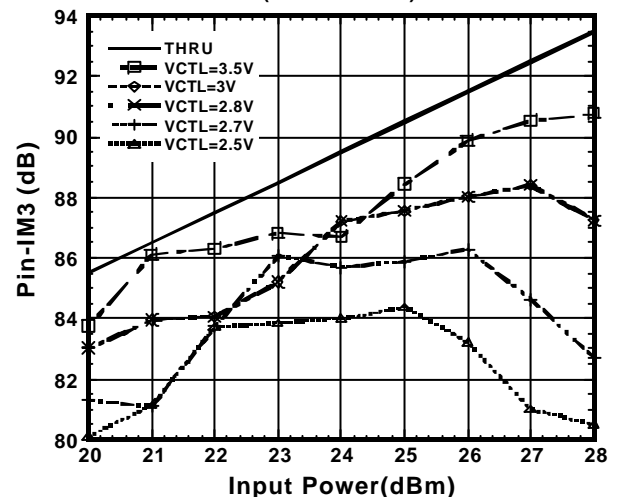

■ ELECTRICAL CHARACTERISTICS (with application circuit, Parts list 3)

ACP vs. Input Power

(f=1GHz, offset=0.9MHz)

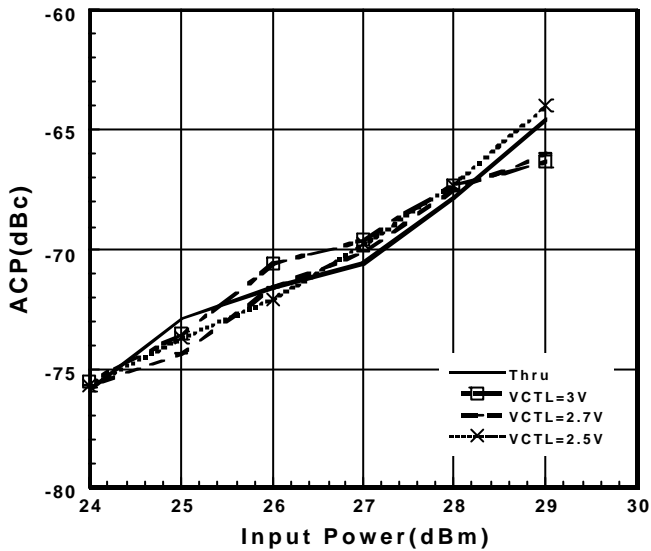

ACP vs. Input Power

(f=1GHz, offset=1.98MHz)

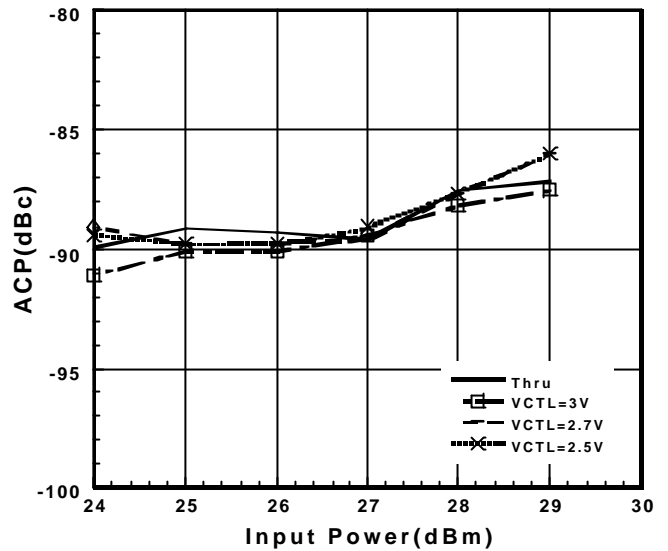

2nd Harmonics vs. Input Power

(f=900MHz)

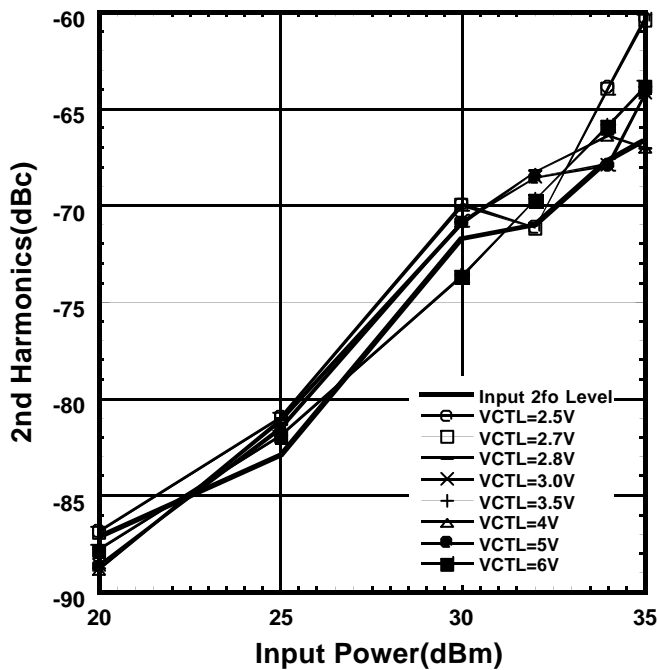

3rd Harmonics vs. Input Power

(f=900MHz)

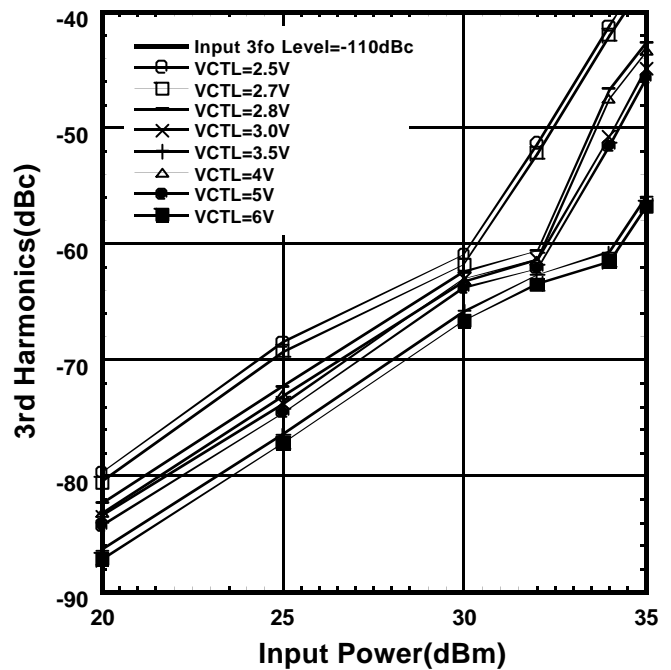

NJG1516KC1

ELECTRICAL CHARACTERISTICS (with application circuit, Parts list 3)

2nd Harmonics vs. Input Power

(f=1800MHz)

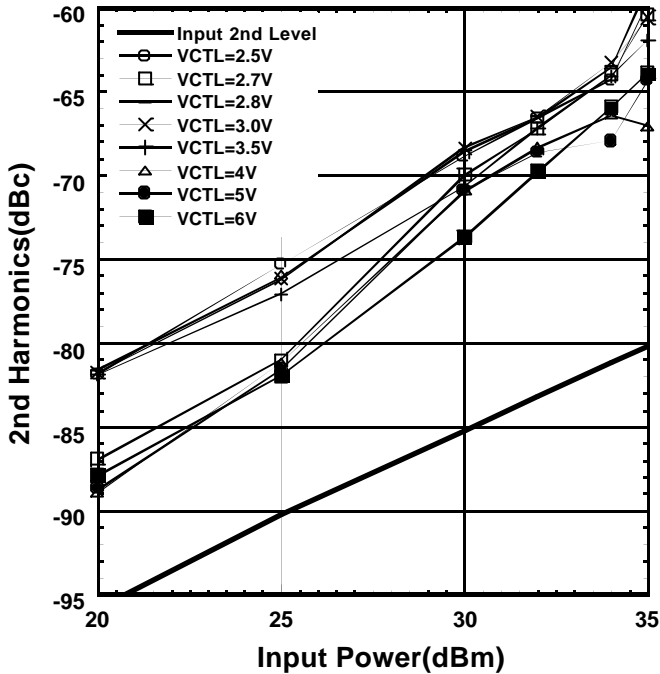

3rd Harmonics vs. Input Power

(f=1800MHz)

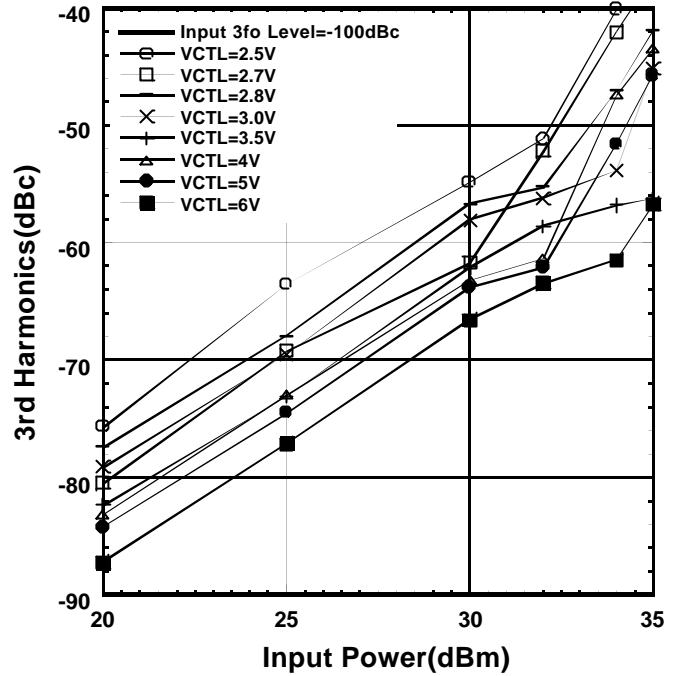

Insertion Loss vs. Ambient Temperature

(PC-P1, f=1GHz, Input Power=34.5dBm)

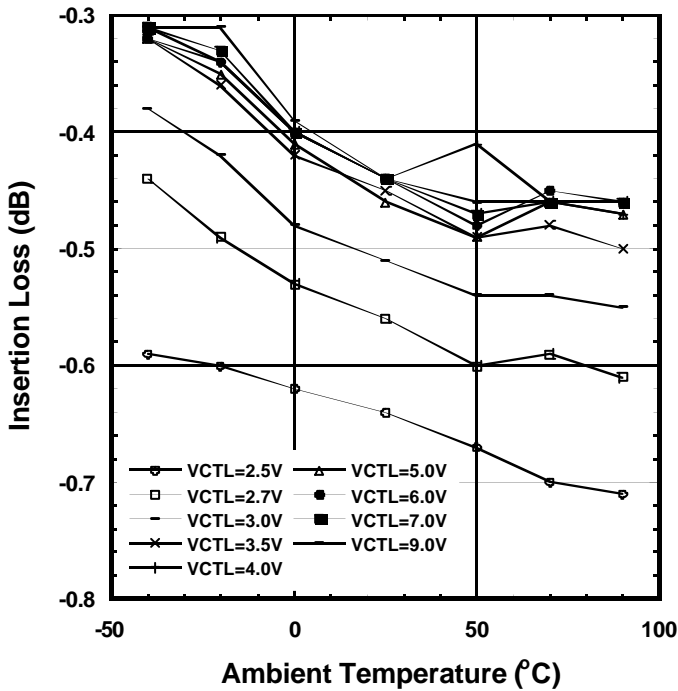

Insertion Loss vs. Ambient Temperature

(PC-P1, f=2GHz, Input Power=31.5dBm)

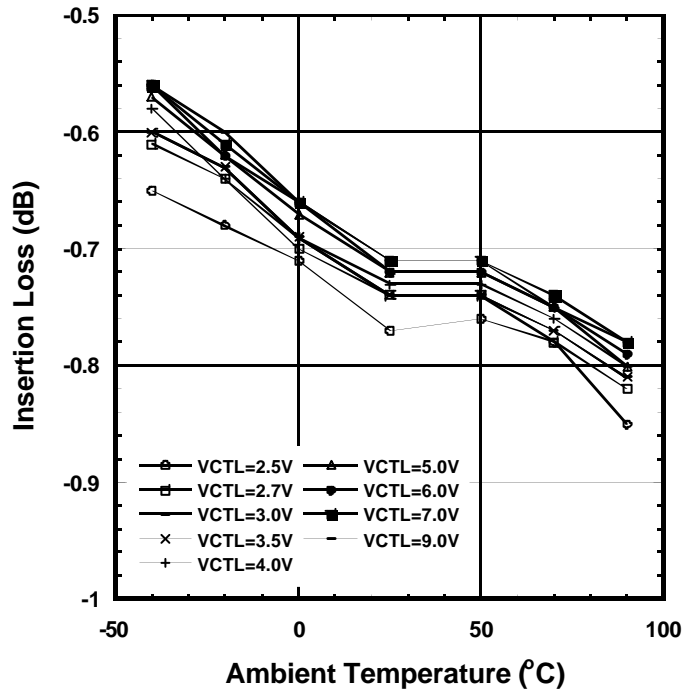

ELECTRICAL CHARACTERISTICS (with application circuit, Parts list 3)

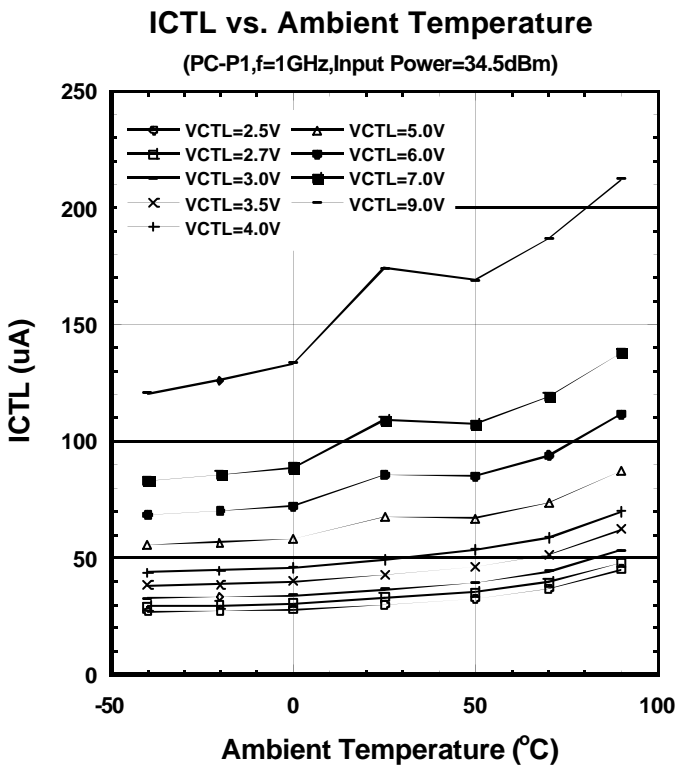
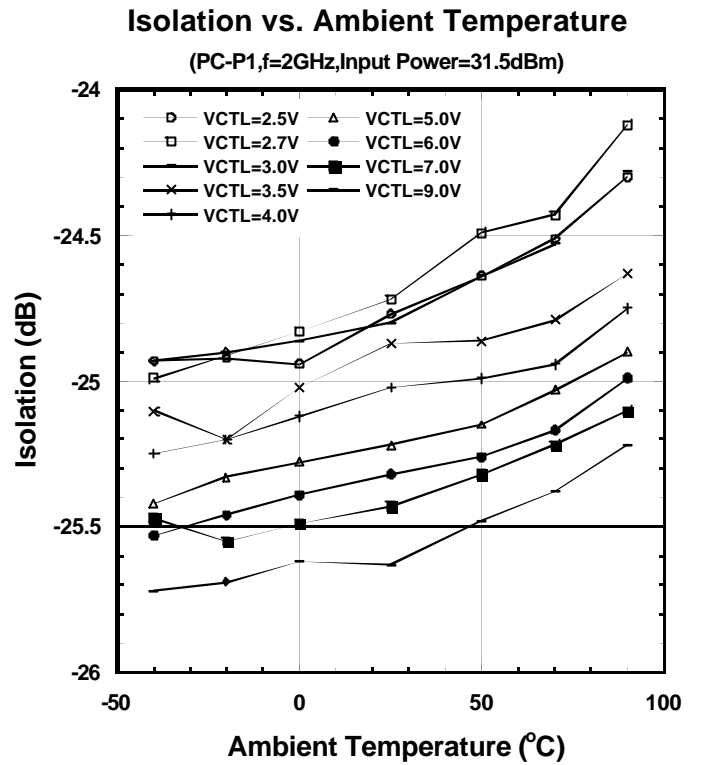
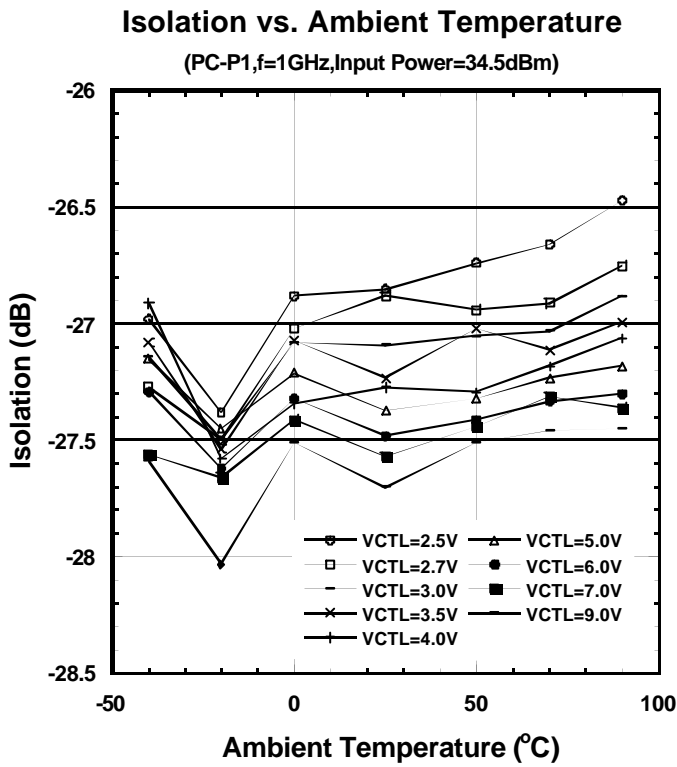

NJG1516KC1

TEMPERATURE CHARACTERISTICS (with application circuit, Parts list 3)

IIP3 vs. Ambient Temperature

(PC-P1, f=900+901MHz, Input Power=25dBm)

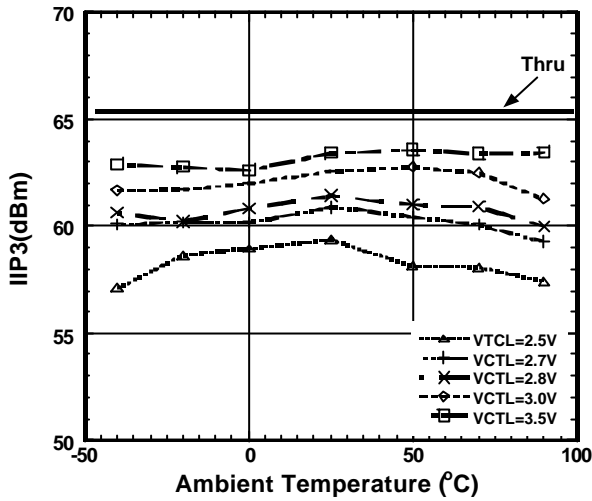

2nd Harmonics vs. Ambient Temperature

(f=900MHz, Input Power=25dBm)

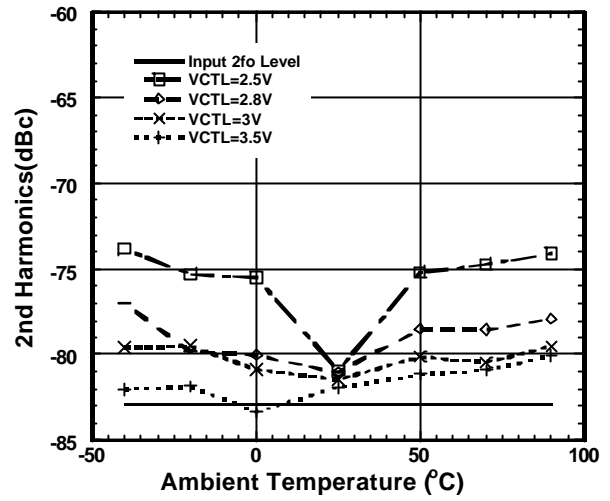

3rd Harmonics vs. Ambient Temperature

(f=900MHz, Input Power=25dBm)

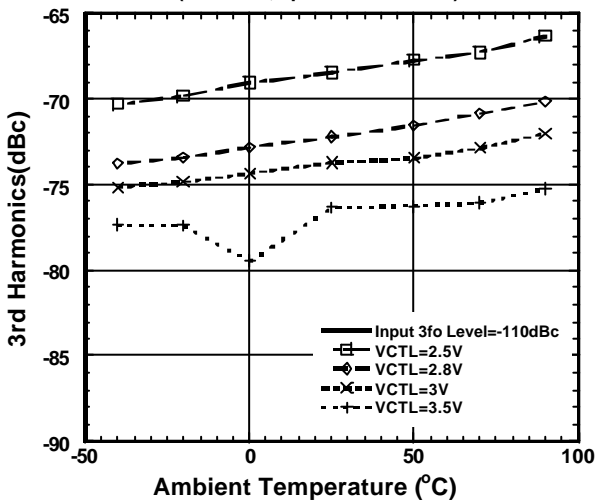

2nd Harmonics vs. Ambient Temperature

(f=1800MHz, Input Power=25dBm)

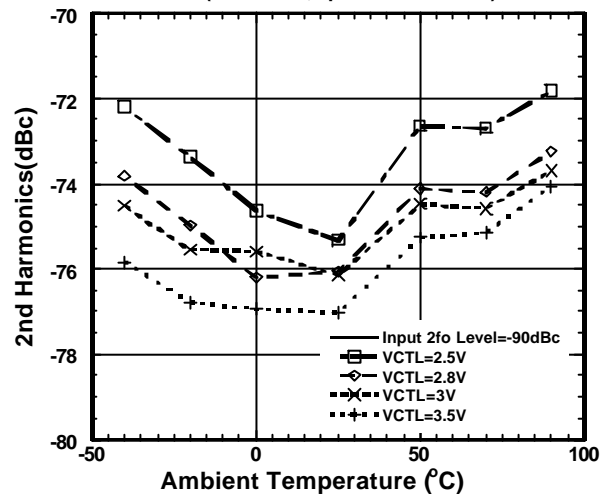

3rd Harmonics vs. Ambient Temperature

(f=1800MHz, Input Power=25dBm)

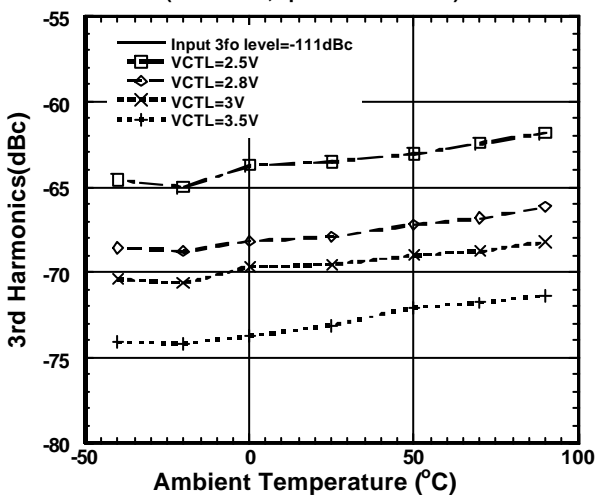

APPLICATION CIRCUIT 1 (Parts list 1~3)

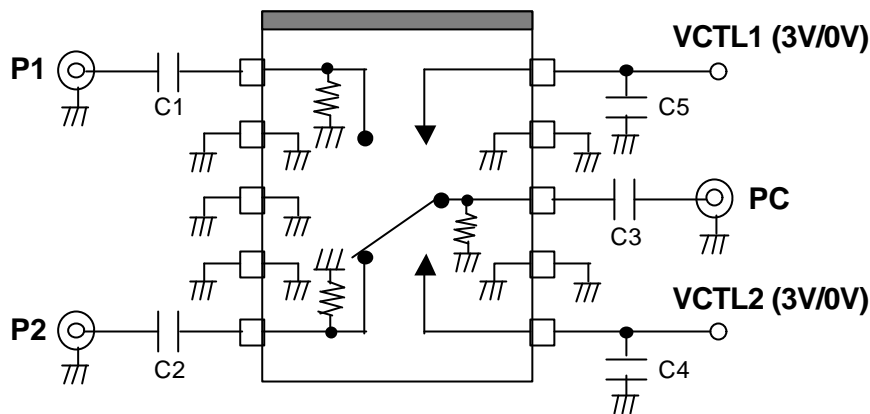

RECOMMENDED PCB DESIGN

(TOP VIEW)

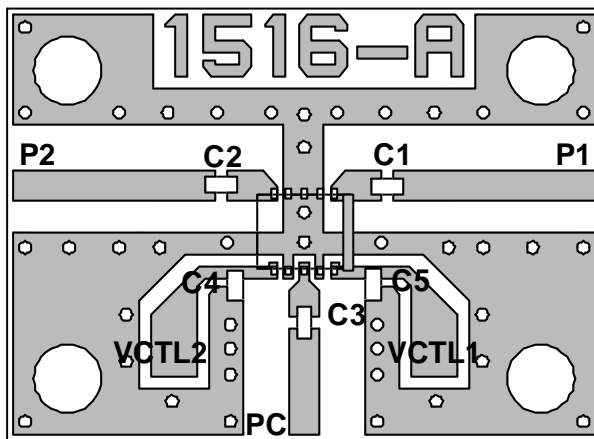

PCB: FR-4, t=0.5mm
 Capacitor: size 1005
 Strip Line Width=1.0mm
 PCB SIZE: 14.0x19.4mm

■Circuit losses including losses of capacitors and connectors.

Frequency (GHz)	Loss (dB)
0.8	0.12
1.0	0.13
1.5	0.17
1.8	0.19
2.0	0.20
2.5	0.26

PARTS LIST

PART ID	1	2	3
Freq (MHz)	50~100	100~500	500~2000
C1~C3	0.01uF	1000pF	56pF
C4, C5	10pF	10pF	10pF

PRECAUTIONS

- [1]The DC blocking capacitors have to be placed at RF terminal of P1, P2 and PC.
- [2]Bypass capacitors (C4, C5) should be placed close to terminals of VCTL1, VCTL2 to reduce stripline influence of RF characteristics.
- [3]For good isolation, the GND terminal (3rd, 6th, 7th pin) must be placed possibly close to ground plane of substrate, and through holes for GND should be placed near by the pin connection.
- [4] To avoid degradation of isolation or high power characteristics, please layout ground pattern right under this IC.

NJG1516KC1

■ PACKAGE OUTLINE (FLP10-C1)

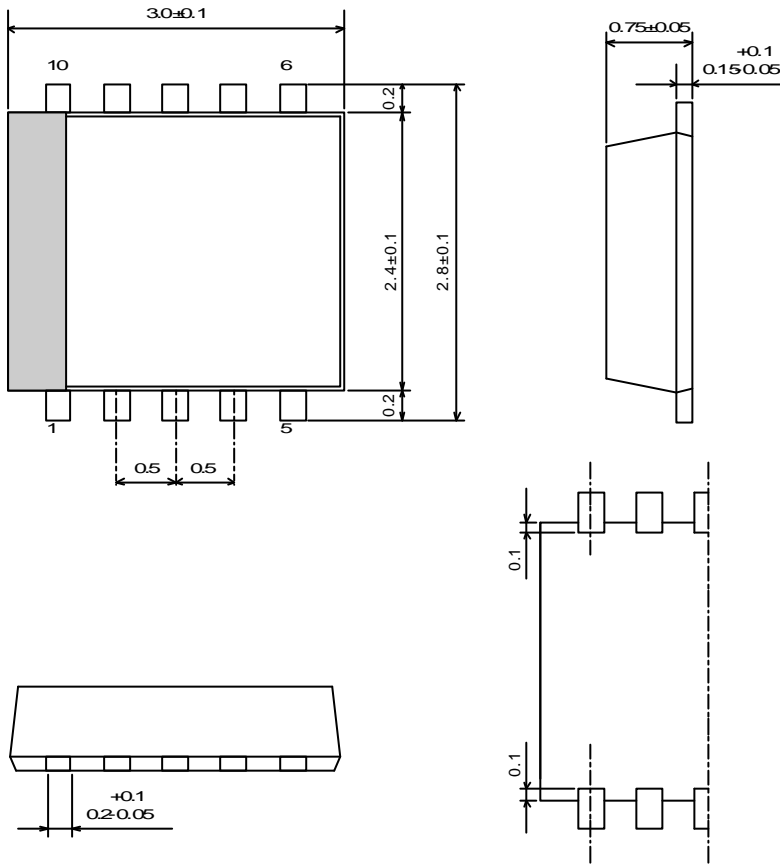

Lead material : Copper
 Lead surface finish : Solder plating
 Molding material : Epoxy resin
 UNIT : mm
 Weight : 15mg

Cautions on using this product

This product contains Gallium-Arsenide (GaAs) which is a harmful material.

- Do NOT eat or put into mouth.
- Do NOT dispose in fire or break up this product.
- Do NOT chemically make gas or powder with this product.
- To waste this product, please obey the relating law of your country.

[CAUTION]

The specifications on this databook are only given for information, without any guarantee as regards either mistakes or omissions. The application circuits in this databook are described only to show representative usages of the product and not intended for the guarantee or permission of any right including the industrial rights.

This product may be damaged with electric static discharge (ESD) or spike voltage. Please handle with care to avoid these damages.