

NC7WZ38 TinyLogic® UHS Dual 2-Input NAND Gate (Open Drain Output)

General Description

The NC7WZ38 is a dual 2-Input NAND Gate with open drain output stage from Fairchild's Ultra High Speed Series of TinyLogic®. The device is fabricated with advanced CMOS technology to achieve ultra high speed with high output drive while maintaining low static power dissipation over a very broad V_{CC} operating range. The device is specified to operate over the 1.65V to 5.5V V_{CC} range. The inputs and output are high impedance when V_{CC} is 0V. Inputs tolerate voltages up to 7V independent of V_{CC} operating voltage. The open drain output stage will tolerate voltages up to 7V independent of V_{CC} when in the high impedance state.

Features

- Space saving US8 surface mount package
- MicroPak™ leadless package
- Open Drain output stage for OR tied applications
- Ultra High Speed; t_{PD} 2.2 ns Typ into 50 pF at 5V V_{CC}
- High Output Sink Drive; 24 mA at 3V V_{CC}
- Broad V_{CC} Operating Range; 1.65V to 5.5V
- Matches the performance of LCX when operated at 3.3V V_{CC}
- Power down high impedance inputs/output
- Overvoltage Tolerant inputs facilitate 5V to 3V translation
- Patented noise/EMI reduction circuitry implemented

Ordering Code:

Order Number	Package Number	Product Code Top Mark	Package Description	Supplied As
NC7WZ38K8X	MAB08A	WZ38	8-Lead US8, JEDEC MO-187, Variation CA 3.1mm Wide	3k Units on Tape and Reel
NC7WZ38L8X (Preliminary)	MAC08A	U5	8-Lead MicroPak, 1.6 mm Wide	5k Units on Tape and Reel

TinyLogic® is a registered trademark of Fairchild Semiconductor Corporation.
MicroPak™ is a trademark of Fairchild Semiconductor Corporation.

NC7WZ38 TinyLogic® UHS Dual 2-Input NAND Gate (Open Drain Output)

Logic Symbol

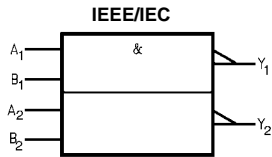

Pin Descriptions

Pin Names	Description
A _n , B _n	Inputs
Y _n	Output

Function Table

$$Y = \overline{AB}$$

Inputs		Output
A	B	Y
L	L	*H
L	H	*H
H	L	*H
H	H	L

H = HIGH Logic Level
 L = LOW Logic Level
 *H = HIGH Impedance output state (Open Drain)

Connection Diagrams

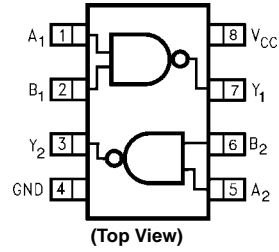

Pin One Orientation Diagram

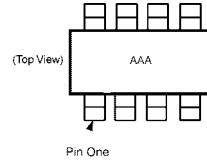

AAA represents Product Code Top Mark - see ordering code
Note: Orientation of Top Mark determines Pin One location. Read the top product code mark left to right, Pin One is the lower left pin (see diagram).

Pad Assignments for MicroPak

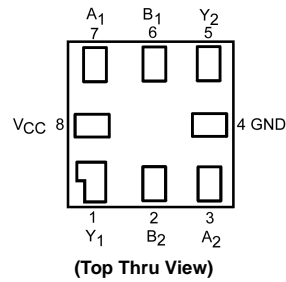

Absolute Maximum Ratings (Note 1)

Supply Voltage (V_{CC})	-0.5V to +7V
DC Input Voltage (V_{IN})	-0.5V to +7V
DC Output Voltage (V_{OUT})	-0.5V to +7V
DC Input Diode Current (I_{IK}) @ $V_{IN} < -0.5V$	-50 mA
DC Output Diode Current (I_{OK}) @ $V_{OUT} < -0.5V$	-50 mA
DC Output Current (I_{OUT})	+50 mA
DC V_{CC}/GND Current (I_{CC}/I_{GND})	± 100 mA
Storage Temperature (T_{STG})	-65°C to +150°C
Junction Temperature under Bias (T_J)	150°C
Junction Lead Temperature (T_L); (Soldering, 10 seconds)	260°C
Power Dissipation (P_D) @ +85°C	250 mW

Recommended Operating Conditions (Note 2)

Supply Voltage Operating (V_{CC})	1.65V to 5.5V
Supply Voltage Data Retention (V_{CC})	1.5V to 5.5V
Input Voltage (V_{IN})	0V to 5.5V
Output Voltage (V_{OUT})	0V to V_{CC}
Operating Temperature (T_A)	-40°C to +85°C
Input Rise and Fall Time (t_r, t_f) $V_{CC} = 1.8V \pm 0.15V, 2.5V \pm 0.2V$	0 ns/V to 20 ns/V
$V_{CC} = 3.3V \pm 0.3V$	0 ns/V to 10 ns/V
$V_{CC} = 5.0V \pm 0.5V$	0 ns/V to 5 ns/V
Thermal Resistance (θ_{JA})	250°C/W

Note 1: Absolute maximum ratings are DC values beyond which the device may be damaged or have its useful life impaired. The datasheet specifications should be met, without exception, to ensure that the system design is reliable over its power supply, temperature, and output/input loading variables. Fairchild does not recommend operation outside datasheet specifications.

Note 2: Unused inputs must be held HIGH or LOW. They may not float.

DC Electrical Characteristics

Symbol	Parameter	V_{CC} (V)	$T_A = +25^\circ\text{C}$			$T_A = -40^\circ\text{C to } +85^\circ\text{C}$		Units	Conditions
			Min	Typ	Max	Min	Max		
V_{IH}	HIGH Level	1.65 to 1.95	0.75 V_{CC}			0.75 V_{CC}		V	
	Input Voltage	2.3 to 5.5	0.7 V_{CC}			0.7 V_{CC}			
V_{IL}	LOW Level	1.65 to 1.95	0.25 V_{CC}			0.25 V_{CC}		V	
	Input Voltage	2.3 to 5.5	0.3 V_{CC}			0.3 V_{CC}			
I_{LKG}	HIGH Level Output Leakage	5.5	± 5			± 10		μA	$V_{IN} = V_{IL}$ $V_{OUT} = V_{CC}$ or GND
V_{OL}	LOW Level Output Voltage	1.65	0.0	0.1	0.1		V	$V_{IN} = V_{IH}$	$I_{OL} = 100 \mu\text{A}$
		2.3	0.0	0.1	0.1				
	3.0	0.0	0.1	0.1		V		$I_{OL} = 4 \text{ mA}$ $I_{OL} = 8 \text{ mA}$ $I_{OL} = 16 \text{ mA}$ $I_{OL} = 24 \text{ mA}$ $I_{OL} = 32 \text{ mA}$	
	4.5	0.0	0.1	0.1					
	1.65	0.08	0.24	0.24					
	2.3	0.10	0.3	0.3					
3.0	0.15	0.4	0.4						
4.5	0.22	0.55	0.55						
I_{IN}	Input Leakage Current	5.5	± 0.1			± 1		μA	$V_{IN} = 5.5V, \text{GND}$
I_{OFF}	Power Off Leakage Current	0.0	1			10		μA	V_{IN} or $V_{OUT} = 5.5V$
I_{CC}	Quiescent Supply Current	1.65 to 5.5	1			10		μA	$V_{IN} = 5.5V, \text{GND}$

AC Electrical Characteristics

Symbol	Parameter	V _{CC} (V)	T _A = +25°C			T _A = -40°C to +85°C		Units	Conditions	Figure Number
			Min	Typ	Max	Min	Max			
t _{PZL}	Propagation Delay	1.8 ± 0.15	2.0	5.2	9.2	2.0	9.6	ns	C _L = 50 pF R _U = 500Ω R _D = 500Ω V _I = 2 × V _{CC}	Figures 1, 3
		2.5 ± 0.2	1.5	3.5	5.7	1.5	6.1			
		3.3 ± 0.3	1.0	2.8	4.1	1.0	4.5			
		5.0 ± 0.5	0.5	2.2	3.4	0.5	3.6			
t _{PLZ}	Propagation Delay	1.8 ± 0.15	2.0	4.6	9.2	2.0	9.6	ns	C _L = 50 pF R _U = 500Ω R _D = 500Ω V _I = 2 × V _{CC}	Figures 1, 3
		2.5 ± 0.2	1.5	3.2	5.7	1.5	6.1			
		3.3 ± 0.3	1.0	2.4	4.1	1.0	4.5			
		5.0 ± 0.5	0.5	1.6	3.4	0.5	3.6			
C _{IN}	Input Capacitance	0	2.5					pF		
C _{OUT}	Output Capacitance	0	4.2					pF		
C _{PD}	Power Dissipation	3.3	7					pF	(Note 3)	Figure 2
	Capacitance	5.0	9							

Note 3: C_{PD} is defined as the value of the internal equivalent capacitance which is derived from dynamic operating current consumption (I_{CCD}) at no output loading and operating at 50% duty cycle. (See Figure 2.) C_{PD} is related to I_{CCD} dynamic operating current by the expression:

$$I_{CCD} = (C_{PD}) (V_{CC}) (f_{IN}) + (I_{CC \text{ static}}).$$

AC Loading and Waveforms

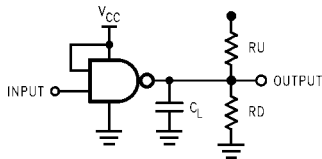

C_L includes load and stray capacitance
Input PRR = 1.0 MHz; t_w = 500 ns

FIGURE 1. AC Test Circuit

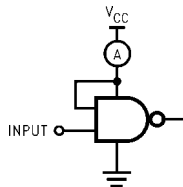

Input = AC Waveform; t_r = t_f = 1.8 ns
PRR = 10 MHz; Duty Cycle = 50%

FIGURE 2. I_{CCD} Test Circuit

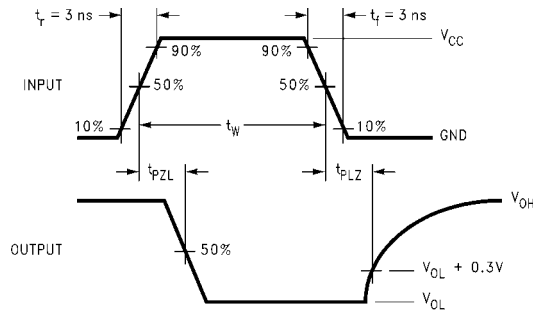
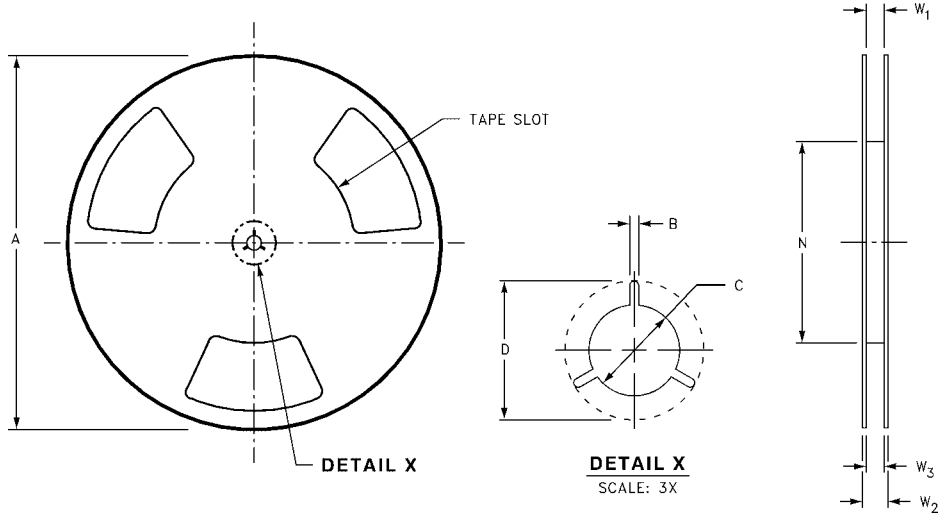

FIGURE 3. AC Waveforms

Tape and Reel Specification (Continued)

REEL DIMENSIONS inches (millimeters)



Tape Size	A	B	C	D	N	W1	W2	W3
8 mm	7.0 (177.8)	0.059 (1.50)	0.512 (13.00)	0.795 (20.20)	2.165 (55.00)	$0.331 + 0.059/-0.000$ ($8.40 + 1.50/-0.00$)	0.567 (14.40)	$W1 + 0.078/-0.039$ ($W1 + 2.00/-1.00$)

Physical Dimensions inches (millimeters) unless otherwise noted

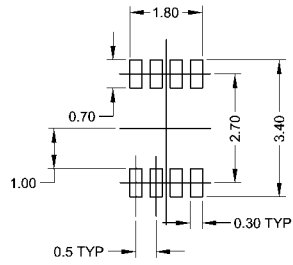
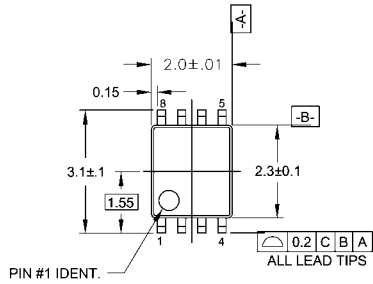

LAND PATTERN RECOMMENDATION

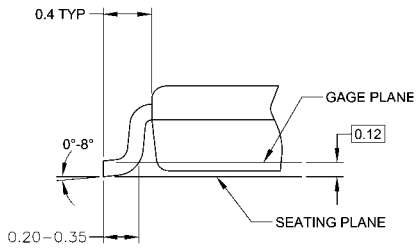
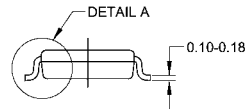
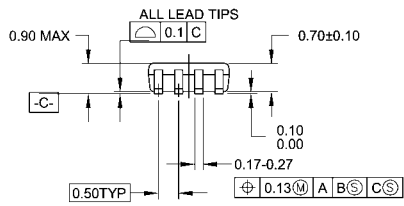

DETAIL A

NOTES:

- A. CONFORMS TO JEDEC REGISTRATION MO-187
- B. DIMENSIONS ARE IN MILLIMETERS.
- C. DIMENSIONS ARE EXCLUSIVE OF BURRS, MOLD FLASH, AND TIE BAR EXTRUSIONS.
- D. DIMENSIONS AND TOLERANCES PER ANSI Y14.5M, 1982.

MAB08AREVC

**8-Lead US8, JEDEC MO-187, Variation CA 3.1mm Wide
Package Number MAB08A**

Physical Dimensions inches (millimeters) unless otherwise noted (Continued)

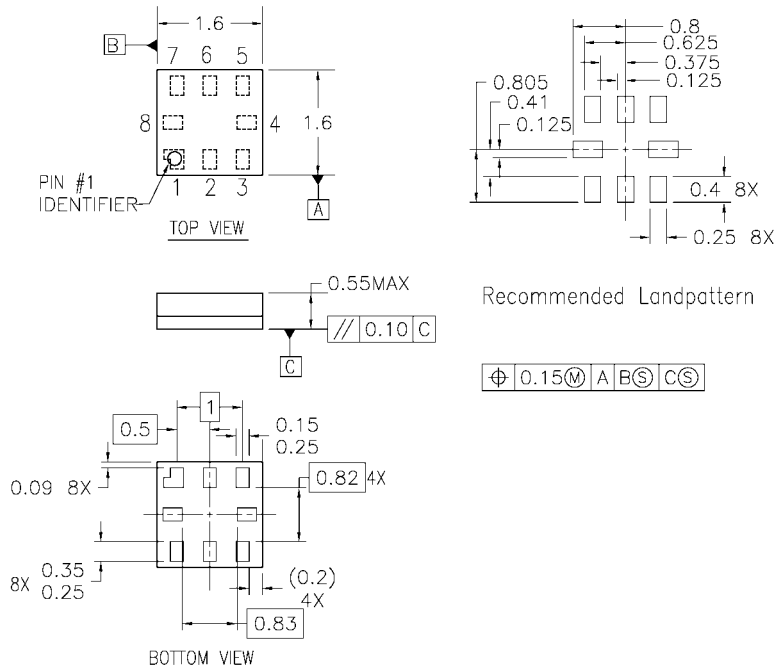

- Notes:
1. PACKAGE REGISTRATION WITH JEDEC IS ANTICIPATED
 2. DIMENSIONS ARE IN MILLIMETERS
 3. DRAWING CONFORMS TO ASME Y.14M-1994

MAC08AREVB

**8-Lead MicroPak, 1.6 mm Wide
Package Number MAC08A
(Preliminary)**

Fairchild does not assume any responsibility for use of any circuitry described, no circuit patent licenses are implied and Fairchild reserves the right at any time without notice to change said circuitry and specifications.

LIFE SUPPORT POLICY

FAIRCHILD'S PRODUCTS ARE NOT AUTHORIZED FOR USE AS CRITICAL COMPONENTS IN LIFE SUPPORT DEVICES OR SYSTEMS WITHOUT THE EXPRESS WRITTEN APPROVAL OF THE PRESIDENT OF FAIRCHILD SEMICONDUCTOR CORPORATION. As used herein:

1. Life support devices or systems are devices or systems which, (a) are intended for surgical implant into the body, or (b) support or sustain life, and (c) whose failure to perform when properly used in accordance with instructions for use provided in the labeling, can be reasonably expected to result in a significant injury to the user.
2. A critical component in any component of a life support device or system whose failure to perform can be reasonably expected to cause the failure of the life support device or system, or to affect its safety or effectiveness.

www.fairchildsemi.com