

# M-Pulse Microwave

## Silicon Bipolar MMIC Cascadable Amplifier

### MP4TD0370

#### Features

- Cascadable 50Ω Gain Block
- 3dB Bandwidth: DC to 2.0 GHz
- 12.0 dB Typical Gain @ 1.0 GHz
- Unconditionally Stable ( $k > 1$ )
- Hermetic Gold-Ceramic Microstrip Package
- Tape and Reel Packaging Available

#### Description

M-Pulse's MP4TD0370 is a high performance silicon bipolar MMIC housed in a hermetic high reliability package for surface mount usage. The MP4TD0370 is useful where a general purpose 50Ω gain block is required. Typical applications include narrow and wide band IF and RF amplifiers in industrial and military applications.

The MP4TD0370 is fabricated using a 10 GHz  $f_T$  silicon bipolar technology that features gold metalization and IC passivation for increased performance and reliability.

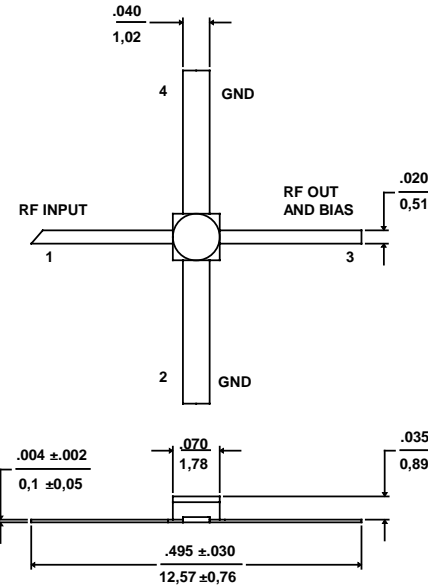

Notes: (unless otherwise specified)

1. Dimensions are in / mm
2. Tolerance: in .xxx = ±.005; mm .xx = ±.13

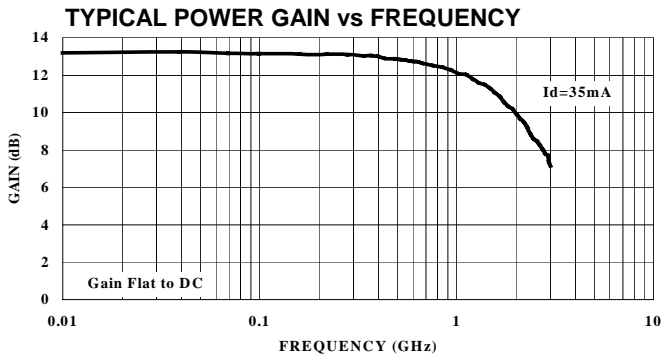

#### Pin Configuration

Pin Number	Pin Description
1	RF Input
2 & 4	AC/DC Ground
3	RF Output and DC Bias

#### Gold-Ceramic Microstrip Package Outline<sup>1,2</sup>

#### Electrical Specifications @ $T_A = +25^\circ\text{C}$ , $I_d = 35 \text{ mA}$ , $Z_0 = 50\Omega$

Symbol	Parameters	Test Conditions	Units	Min.	Typ.	Max.
$G_p$	Power Gain ( $ S_{21} ^2$ )	$f = 0.1 \text{ GHz}$	dB	11.5	12.5	13.5
$\Delta G_p$	Gain Flatness	$f = 0.1 \text{ to } 1.6 \text{ GHz}$	dB	-	±0.9	±1.2
$f_{3 \text{ dB}}$	3 dB Bandwidth	-	GHz	-	2.0	-
$V_{\text{SWRin}}$	Input VSWR	$f = 0.1 \text{ to } 3.0 \text{ GHz}$	-	-	1.6	-
$V_{\text{SWRout}}$	Output VSWR	$f = 0.1 \text{ to } 3.0 \text{ GHz}$	-	-	1.5	-
$P_{1 \text{ dB}}$	Output Power @ 1 dB Gain Compression	$f = 1.0 \text{ GHz}$	dBm	-	10.0	-
NF	50 Ω Noise Figure	$f = 1.0 \text{ GHz}$	dB	-	5.5	-
$IP_3$	Third Order Intercept Point	$f = 1.0 \text{ GHz}$	dBm	-	23.0	-
$t_D$	Group Delay	$f = 1.0 \text{ GHz}$	ps	-	125	-
$V_d$	Device Voltage	-	V	4.5	5.0	5.5
$dV/dT$	Device Voltage Temperature Coefficient	-	mV/°C	-	-8.0	-

Specification Subject to Change Without Notice

**Absolute Maximum Ratings<sup>1</sup>**

Parameter	Absolute Maximum
Device Current	80 mA
Power Dissipation <sup>2,3</sup>	425 mW
RF Input Power	+13 dBm
Junction Temperature	200°C
Storage Temperature	-65°C to +150°C

Thermal Resistance:  $\theta_{jC} = 150^{\circ}\text{C}/\text{W}$

1. Exceeding these limits may cause permanent damage.
2. Case Temperature ( $T_c$ ) = 25 °C.
3. Derate at 6.7 mW/°C for  $T_c > 136^{\circ}\text{C}$ .

**Typical Bias Configuration**

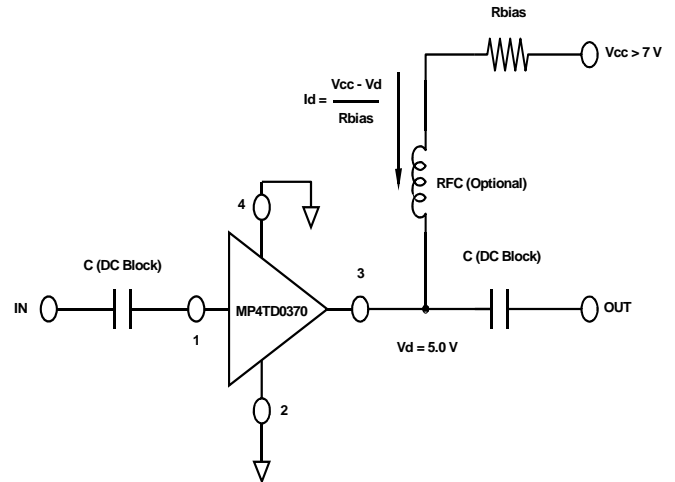

**Typical Performance Curves @  $I_d = 35\text{ mA}$ ,  $T_A = +25^{\circ}\text{C}$  (unless otherwise noted)**

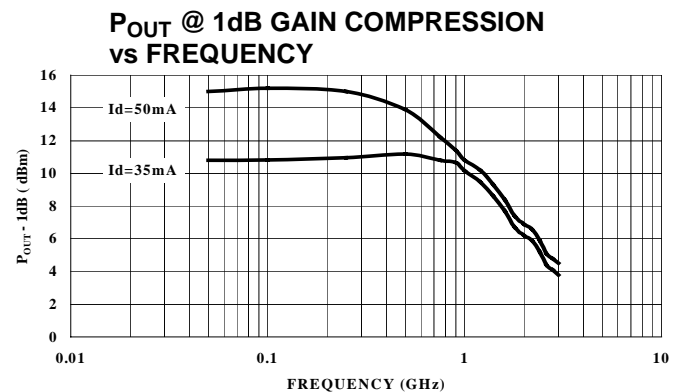
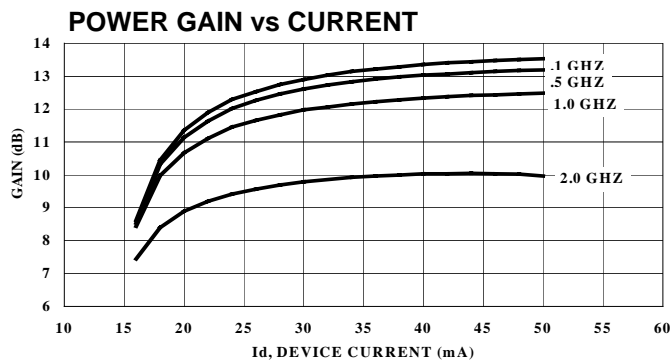
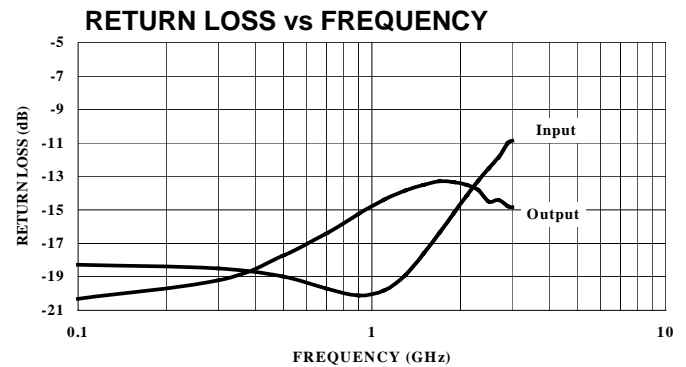
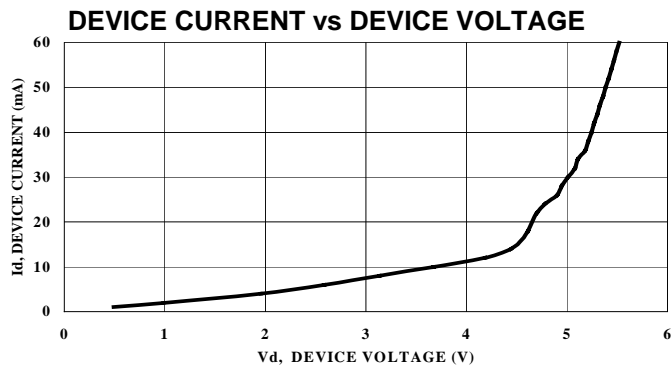

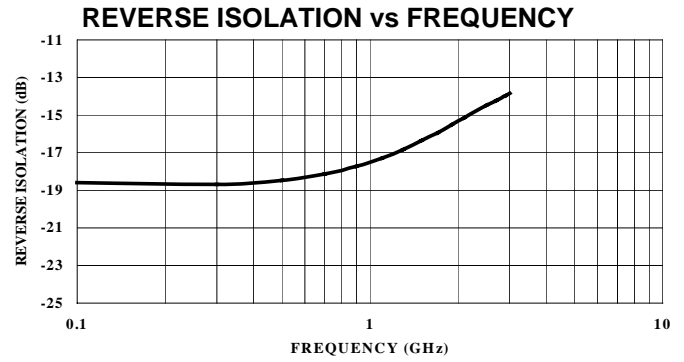
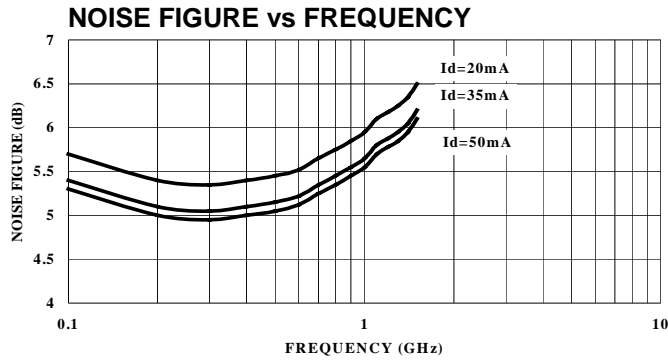

**Typical Scattering Parameters**

Z<sub>0</sub> = 50Ω, T<sub>A</sub> = +25°C, I<sub>d</sub> = 35 mA;

Frequency (GHz)	S <sub>11</sub>		S <sub>21</sub>		S <sub>12</sub>		S <sub>22</sub>	
	Mag.	Angle	Mag.	Angle	Mag.	Angle	Mag	Angle
0.1	0.119	177.7	4.54	172.7	0.114	0.1	0.096	-18.4
0.2	0.118	177.8	4.52	168.0	0.114	3.2	0.102	-30.7
0.4	0.115	175.0	4.45	156.8	0.117	6.6	0.119	-57.0
0.6	0.107	175.4	4.35	145.4	0.121	9.6	0.140	-78.7
0.8	0.099	179.4	4.21	134.2	0.126	12.3	0.162	-95.7
1.0	0.099	-174.0	4.06	123.4	0.133	13.9	0.181	-110.1
1.5	0.131	-162.5	3.60	98.0	0.152	15.8	0.210	-137.3
2.0	0.184	-166.8	3.11	75.1	0.171	14.3	0.212	-156.7
2.5	0.236	-178.4	2.67	55.1	0.189	11.3	0.194	-169.0
3.0	0.287	167.1	2.31	37.7	0.203	7.7	0.180	-178.3
3.5	0.340	151.8	3.03	21.8	0.215	3.6	0.172	174.5
4.0	0.395	137.0	1.80	7.1	0.224	-0.8	0.169	167.0
4.5	0.443	123.4	1.57	-6.2	0.232	-5.3	0.177	159.2
5.0	0.480	113.0	1.39	-18.1	0.235	-9.0	0.194	152.3