

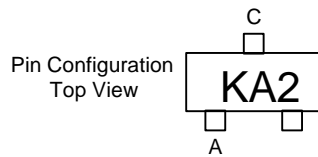


Micro Commercial Components
 21201 Itasca Street Chatsworth
 CA 91311
 Phone: (818) 701-4933
 Fax: (818) 701-4939

MMBD4148

Features

- Low Current Leakage
- Low Cost
- Small Outline Surface Mount Package



350mW 100 Volt Silicon Epitaxial Diode

Maximum Ratings

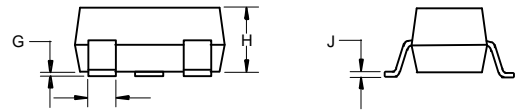
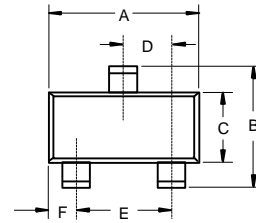
- Operating Temperature: -55°C to +150°C
- Storage Temperature: -55°C to +150°C
- Maximum Thermal Resistance; 357K/W Junction To Ambient

Electrical Characteristics @ 25°C Unless Otherwise Specified

Reverse Voltage	V_R	75V	
Peak Reverse Voltage	V_{RM}	100V	
Average Rectified Current	I_O	150mA	Resistive Load $f > 50\text{Hz}$
Power Dissipation	P_{TOT}	350mW	
Junction Temperature	T_J	150°C	
Peak Forward Surge Current	I_{FSM}	1A	$t=1\text{s, Non-Repitive}$
Maximum Instantaneous Forward Voltage	V_F	.855V	$I_{FM} = 10\text{mA};$ $T_J = 25^\circ\text{C}^*$
Maximum DC Reverse Current At Rated DC Blocking Voltage	I_R	25nA	$T_J = 25^\circ\text{C}$ $V_R = 20\text{V}$
Typical Junction Capacitance	C_J	2pF	Measured at 1.0MHz, $V_R=0\text{V}$
Reverse Recovery Time	T_{rr}	4nS	$I_F=10\text{mA}$ $V_R = 6\text{V}$ $R_L=100\Omega$

*Pulse test: Pulse width 300 μsec , Duty cycle 2%

SOT-23



DIM	INCHES		MM		NOTE
	MIN	MAX	MIN	MAX	
A	.110	.120	2.80	3.04	
B	.083	.098	2.10	2.64	
C	.047	.055	1.20	1.40	
D	.035	.041	.89	1.03	
E	.070	.081	1.78	2.05	
F	.018	.024	.45	.60	
G	.0005	.0039	.013	.100	
H	.035	.044	.89	1.12	
J	.003	.007	.085	.180	
K	.015	.020	.37	.51	

Suggested Solder Pad Layout

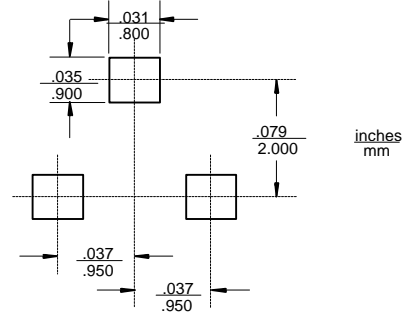
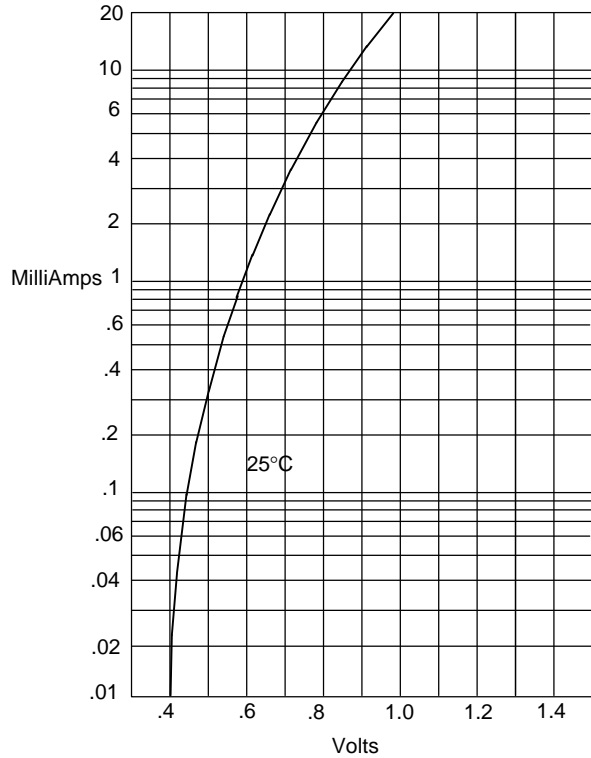
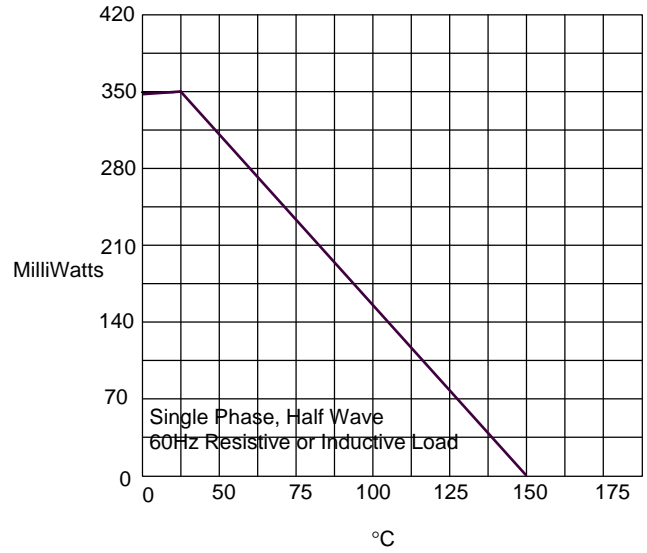


Figure 1
Typical Forward Characteristics



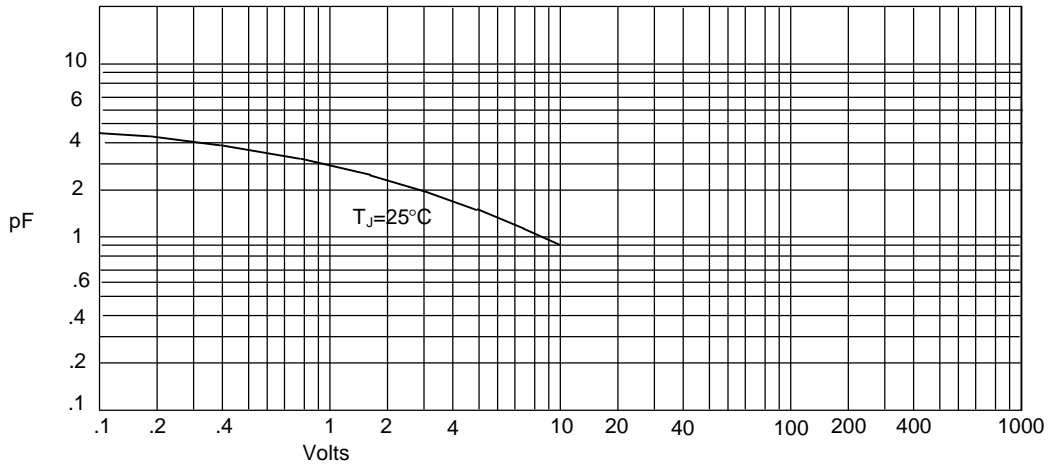
Instantaneous Forward Current - Amperes *versus*
Instantaneous Forward Voltage - Volts

Figure 2
Forward Derating Curve



Admissible Power Dissipation - MilliWatts *versus*
Ambient Temperature - °C

Figure 3
Junction Capacitance

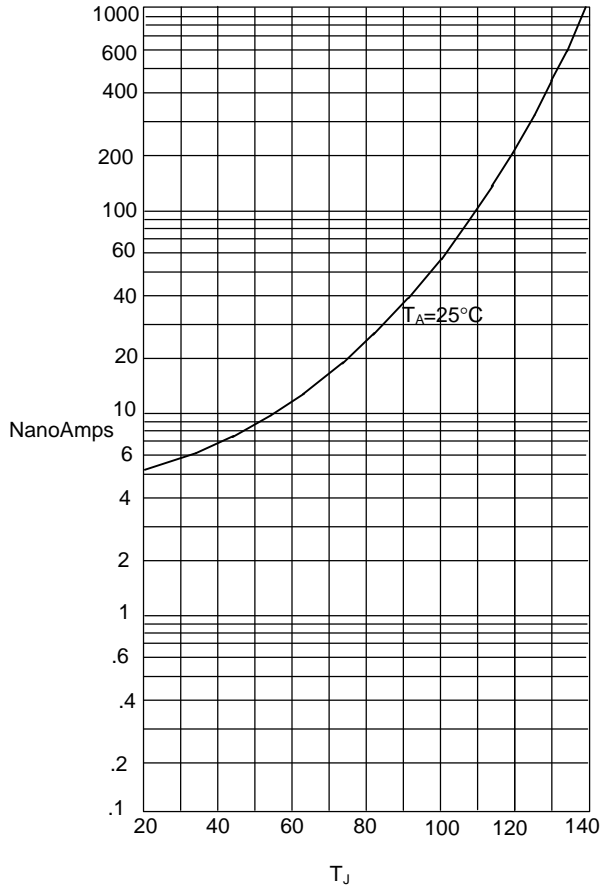


Junction Capacitance - pF *versus*
Reverse Voltage - Volts

MMBD4148

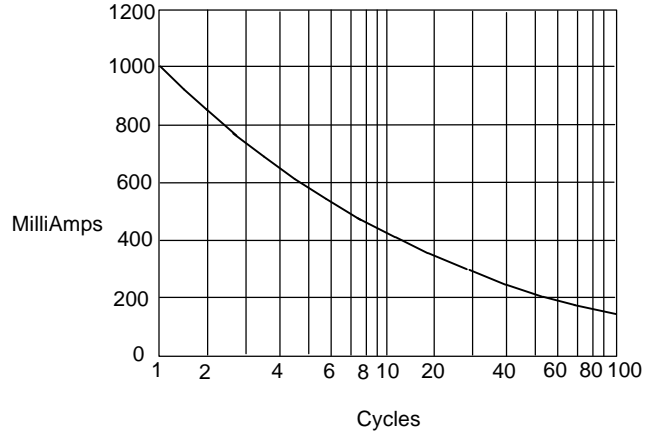


Figure 4
Typical Reverse Characteristics



Instantaneous Reverse Leakage Current - NanoAmperes versus
Junction Temperature - °C

Figure 5
Peak Forward Surge Current



Peak Forward Surge Current - Amperes versus
Number Of Cycles At 60Hz - Cycles