



RF LDMOS Wideband Integrated Power Amplifier

The MHV5IC2215NR2 wideband integrated circuit is designed for base station applications. It uses Freescale's High Voltage (28 Volts) LDMOS IC technology and integrates a two-stage structure. Its wideband on-chip matching design makes it usable from 1500 to 2200 MHz. The linearity performances cover all modulation formats for cellular applications.

Driver Application

- Typical Single-Carrier N-CDMA Performance: $V_{DD} = 28$ Volts, $I_{DQ1} = 164$ mA, $I_{DQ2} = 115$ mA, $P_{out} = 23$ dBm, Full Frequency Band (1930-1990 MHz), IS-95 CDMA (Pilot, Sync, Paging, Traffic Codes 8 Through 13) Channel Bandwidth = 1.2288 MHz. PAR = 9.8 dB @ 0.01% Probability on CCDF.
 Power Gain — 27.5 dB
 ACPR @ 885 kHz Offset — -60 dBc in 30 kHz Bandwidth
- Typical Single-Carrier W-CDMA Performance: $V_{DD} = 28$ Volts, $I_{DQ1} = 164$ mA, $I_{DQ2} = 115$ mA, $P_{out} = 23$ dBm, Full Frequency Band (2130-2170 MHz), Channel Bandwidth = 3.84 MHz, PAR = 8.5 dB @ 0.01% Probability on CCDF.
 Power Gain — 24 dB
 ACPR @ 5 MHz Offset — -55 dBc in 3.84 MHz Channel Bandwidth
- Capable of Handling 3:1 VSWR, @ 28 Vdc, 2170 MHz, 15 Watts CW Output Power
- Characterized with Series Equivalent Large-Signal Impedance Parameters and Common Source Scattering Parameters

Features

- On-Chip Matching (50 Ohm Input, >5 Ohm Output)
- Integrated Quiescent Current Temperature Compensation with Enable/Disable Function
- On-Chip Current Mirror g_m Reference FET for Self Biasing Application (1)
- Integrated ESD Protection
- RoHS Compliant
- In Tape and Reel. R2 Suffix = 1,500 Units per 16 mm, 13 inch Reel

MHV5IC2215NR2

**2170 MHz, 23 dBm, 28 V
 SINGLE N-CDMA, SINGLE W-CDMA
 RF LDMOS WIDEBAND
 INTEGRATED POWER AMPLIFIER**

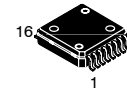

**CASE 978-03
 PFP-16**

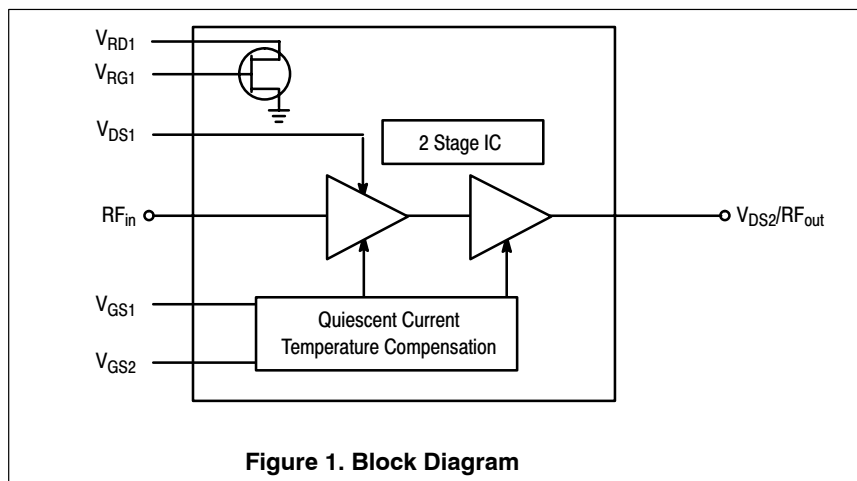
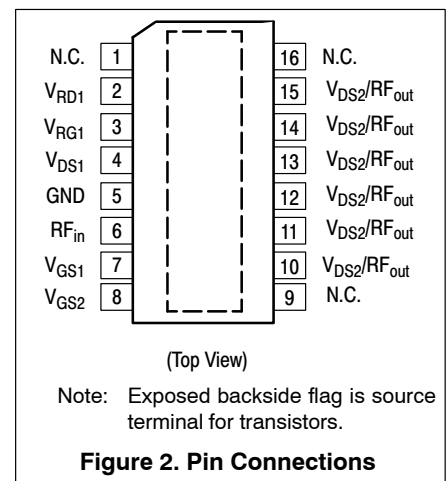

Figure 1. Block Diagram



(Top View)

Note: Exposed backside flag is source terminal for transistors.

Figure 2. Pin Connections

1. Refer to AN1987, *Quiescent Current Control for the RF Integrated Circuit Device Family*. Go to <http://www.freescale.com/rf>. Select Documentation/Application Notes - AN1987.

Table 1. Maximum Ratings

Rating	Symbol	Value	Unit
Drain-Source Voltage	V_{DSS}	-0.5, +65	Vdc
Gate-Source Voltage	V_{GS}	-0.5, +12	Vdc
Storage Temperature Range	T_{stg}	- 65 to +150	°C
Operating Junction Temperature	T_J	150	°C
Input Power	P_{in}	12	dBm

Table 2. Thermal Characteristics

Characteristic	Symbol	Value ⁽¹⁾	Unit
Thermal Resistance, Junction to Case	$R_{\theta JC}$		°C/W
Driver Application		9.3	
($P_{out} = 23$ dBm CW)	Stage 1, 28 Vdc, $I_{DQ1} = 164$ mA Stage 2, 28 Vdc, $I_{DQ2} = 115$ mA	3.5	

Table 3. ESD Protection Characteristics

Test Methodology	Class
Human Body Model (per JESD22-A114)	0 (Minimum)
Machine Model (per EIA/JESD22-A115)	A (Minimum)
Charge Device Model (per JESD22-C101)	III (Minimum)

Table 4. Moisture Sensitivity Level

Test Methodology	Rating	Package Peak Temperature	Unit
Per JESD 22-A113, IPC/JEDEC J-STD-020	3	260	°C

Table 5. Electrical Characteristics ($T_C = 25^\circ\text{C}$ unless otherwise noted)

Characteristic	Symbol	Min	Typ	Max	Unit
----------------	--------	-----	-----	-----	------

W-CDMA Functional Tests (In Freescale Test Fixture, 50 ohm system) $V_{DD} = 28$ Vdc, $I_{DQ1} = 164$ mA, $I_{DQ2} = 115$ mA, $P_{out} = 23$ dBm, $f = 2140$ MHz, Single-carrier W-CDMA, 3.84 MHz Channel Bandwidth Carrier. ACPR measured in 3.84 MHz Channel Bandwidth @ ± 5 MHz Offset. PAR = 8.5 dB @ 0.01% Probability on CCDF.

Power Gain	G_{ps}	23	24	27	dB
Gain Flatness in 60 MHz Bandwidth @ $P_{out} = 23$ dBm $f = 2110$ -2170 MHz	G_F	—	0.3	0.5	dB
Adjacent Channel Power Ratio	ACPR	—	-56	-54	dBc
Input Return Loss	IRL	—	-12	-10	dB

Typical N-CDMA Tests (In Freescale Test Fixture, 50 ohm system) $V_{DD} = 28$ Vdc, $I_{DQ1} = 164$ mA, $I_{DQ2} = 115$ mA, $P_{out} = 23$ dBm, $f = 1960$ MHz, Single-Carrier N-CDMA, 1.2288 MHz Channel Bandwidth Carrier. ACPR measured in 30 kHz Channel Bandwidth @ ± 885 kHz Offset. PAR = 9.8 dB @ 0.01% Probability on CCDF

Power Gain	G_{ps}	25.5	27.5	29	dB
Gain Flatness @ $P_{out} = 23$ dBm $f = 1930$ -1990 MHz	G_F	—	0.3	—	dB
Adjacent Channel Power Ratio	ACPR	—	-60	—	dBc
Input Return Loss	IRL	—	-12	—	dB
Deviation from Linear Phase in 60 MHz Bandwidth @ $P_{out} = 23$ dBm	Φ	—	0.2	—	°
Delay @ $P_{out} = 23$ dBm Including Output Matching	Delay	—	1.5	—	ns

1. Refer to AN1955, *Thermal Measurement Methodology of RF Power Amplifiers*. Go to <http://www.freescale.com/rf>. Select Documentation/Application Notes - AN1955.

W-CDMA DRIVER APPLICATION

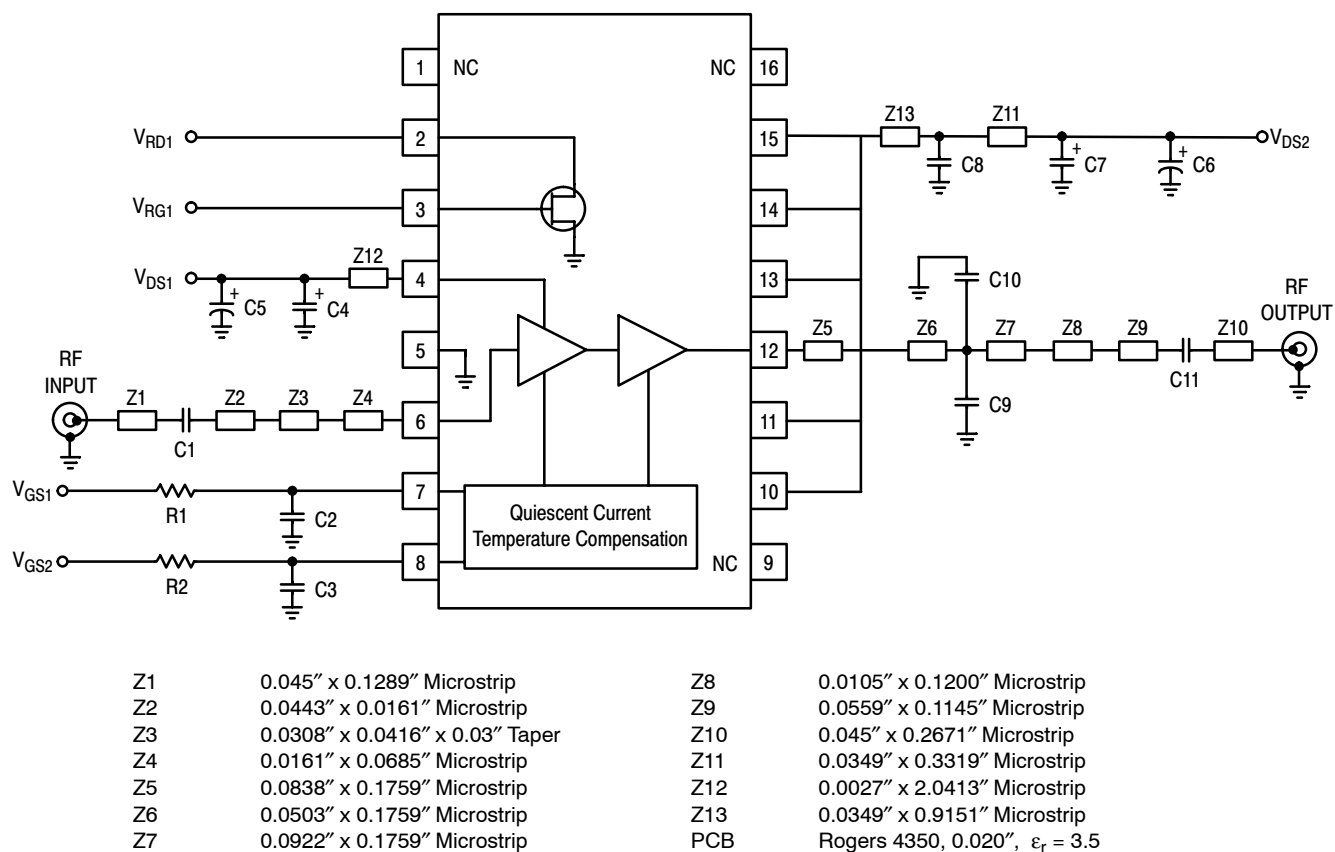

Figure 3. MHV5IC2215NR2 Test Circuit Schematic

Table 6. MHV5IC2215NR2 Test Circuit Component Designations and Values

Part	Description	Part Number	Manufacturer
C1	22 pF, 50 V Chip Capacitor (0603)	06033J220GBT	AVX
C2, C3	6.8 pF, 50 V Chip Capacitors (0603)	06035J6R8BBT	AVX
C4, C7	1 μ F, 35 V Tantalum Chip Capacitors	TAJA105K035R	Kemet
C5, C6	330 μ F, 50 V Electrolytic Chip Capacitors	MCR35V337M10X16	Multicomp
C8	0.01 μ F, 50 V Chip Capacitor (0805)	0805C103K5RACTR	Vishay
C9, C10	2.7 pF, 50 V Chip Capacitors (0603)	06035J2R7BBT	AVX
C11	15 pF, 25 V Chip Capacitor (0603)	06033J150GBT	AVX
R1, R2	1 k Ω Chip Resistors	P1.00KCCT-ND	Panasonic

W-CDMA DRIVER APPLICATION

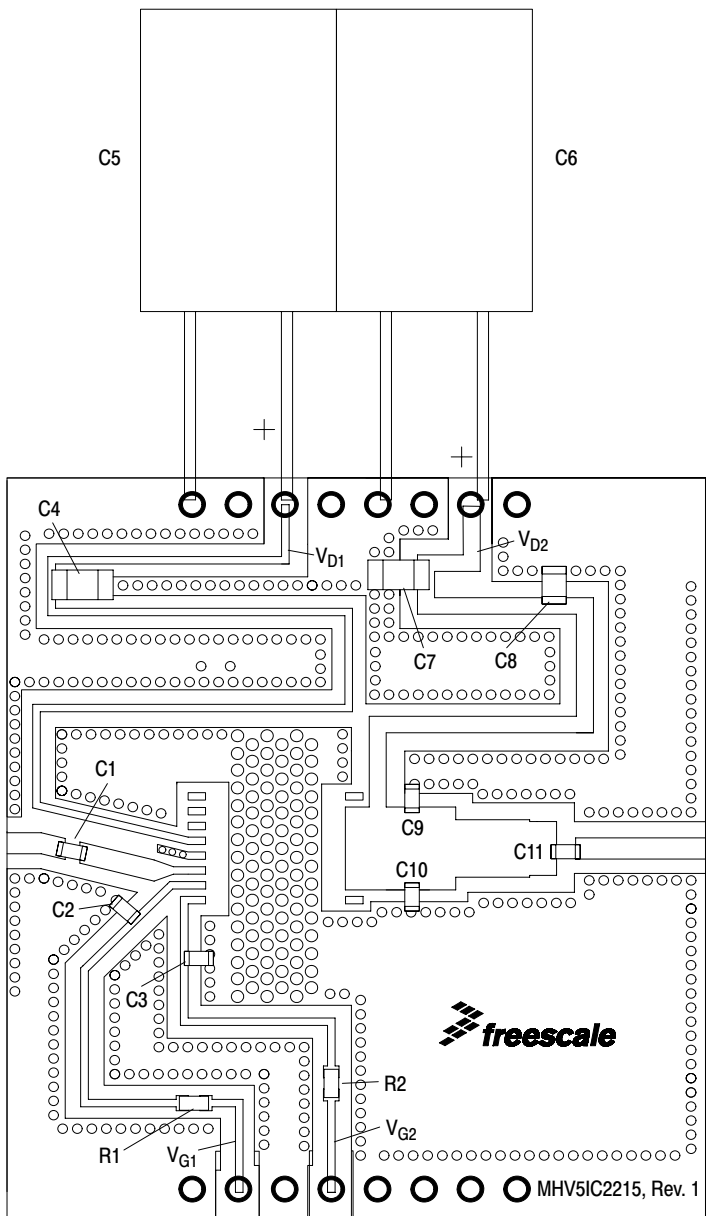

Figure 4. MHV5IC2215NR2 Test Circuit Component Layout

TYPICAL W-CDMA DRIVER APPLICATION CHARACTERISTICS

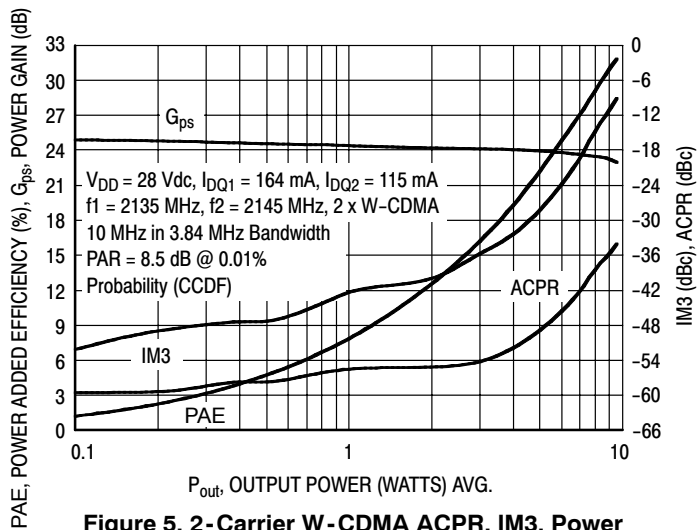

Figure 5. 2-Carrier W-CDMA ACPR, IM3, Power Gain and Power Added Efficiency versus Output Power

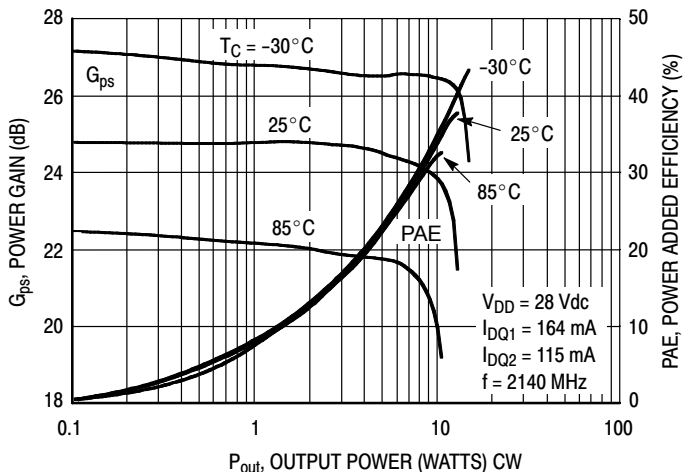

Figure 6. Power Gain and Power Added Efficiency versus Output Power

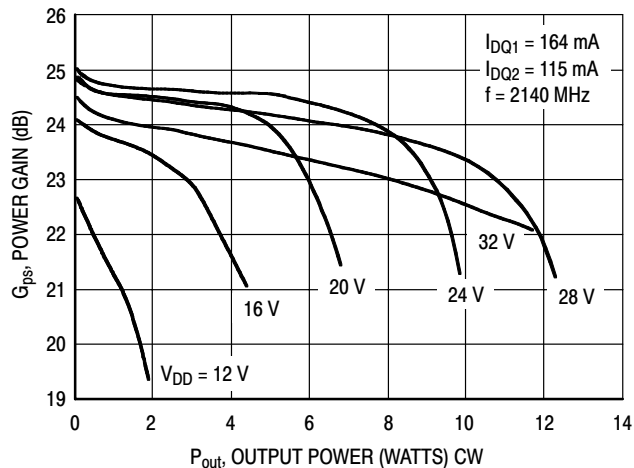

Figure 7. Power Gain versus Output Power

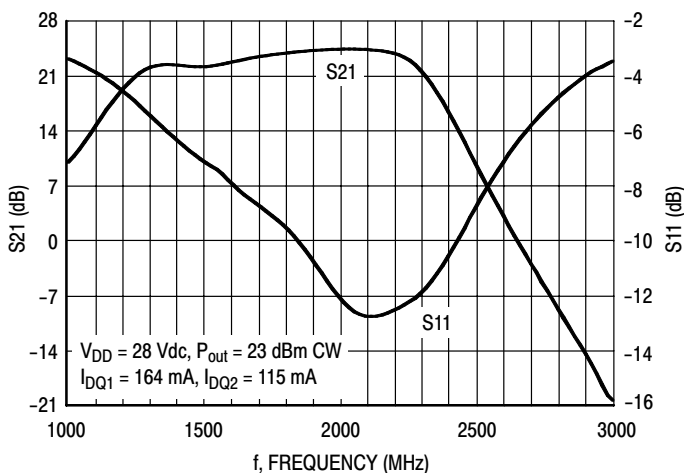

Figure 8. Broadband Frequency Response

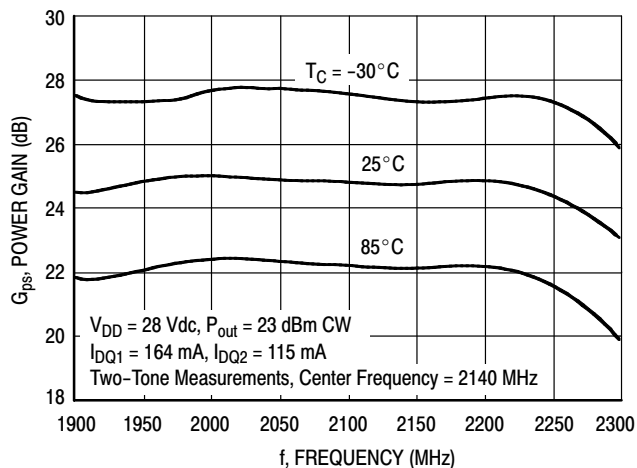
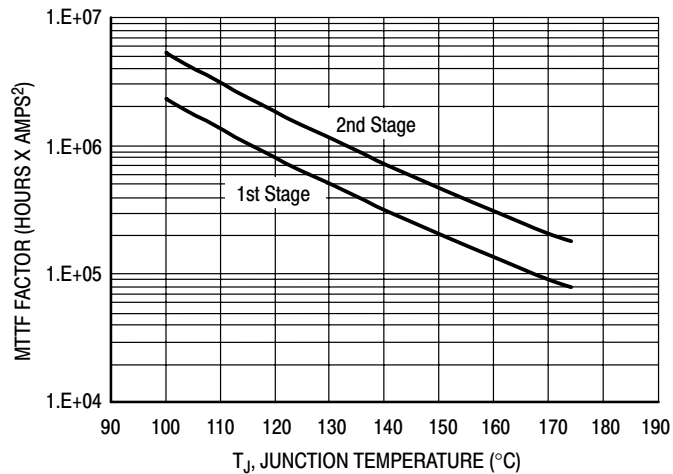

Figure 9. Power Gain versus Frequency

TYPICAL CHARACTERISTICS



This above graph displays calculated MTTF in hours x ampere² drain current. Life tests at elevated temperatures have correlated to better than $\pm 10\%$ of the theoretical prediction for metal failure. Divide MTTF factor by I_D^2 for MTTF in a particular application.

Figure 10. MTTF Factor versus Junction Temperature

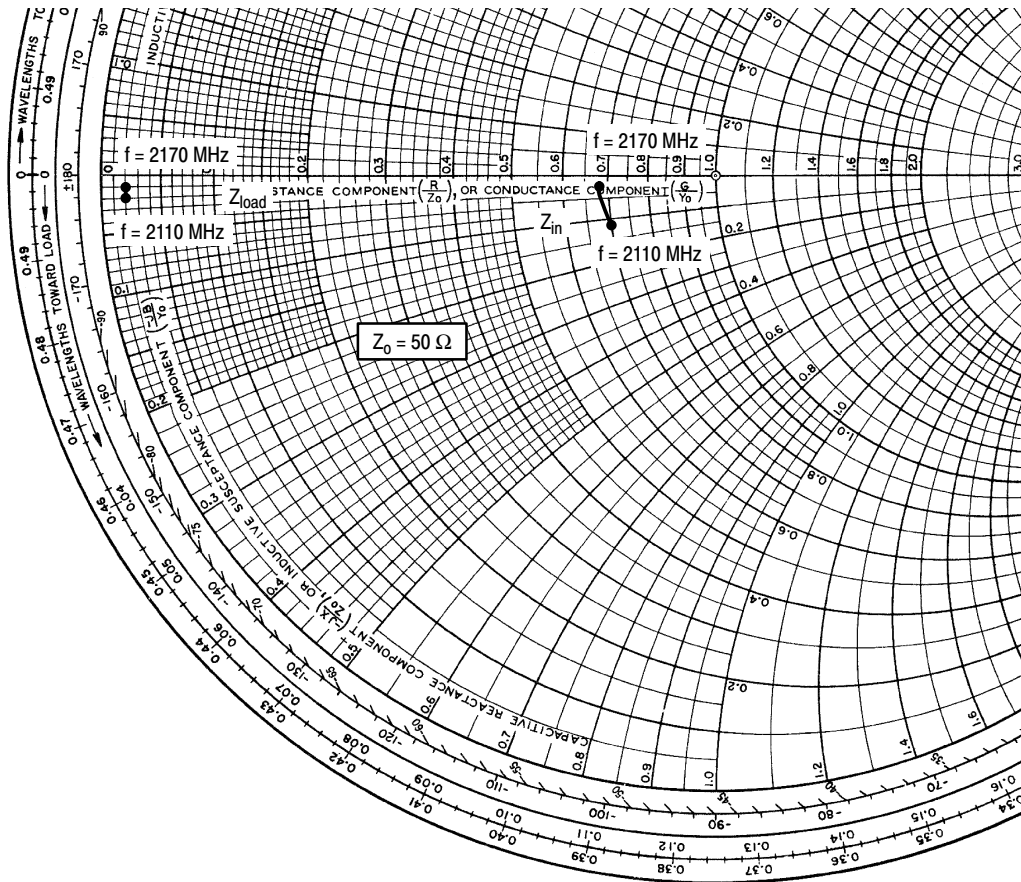

$V_{DD} = 28 \text{ Vdc}$, $I_{DQ1} = 164 \text{ mA}$, $I_{DQ2} = 115 \text{ mA}$, $P_{out} = 23 \text{ dBm}$

f MHz	Z_{in} Ω	Z_{load} Ω
2110	$35.1 - j5.4$	$1.03 - j0.87$
2140	$34.1 - j1.8$	$0.99 - j0.61$
2170	$33.8 - j1.7$	$0.94 - j0.35$

Z_{in} = Device input impedance as measured from gate to ground.

Z_{load} = Test circuit impedance as measured from drain to ground.

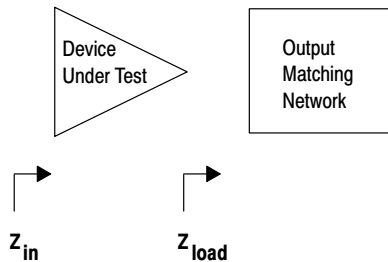

Figure 11. Series Equivalent Input and Load Impedance, 2140 MHz

N-CDMA DRIVER APPLICATION

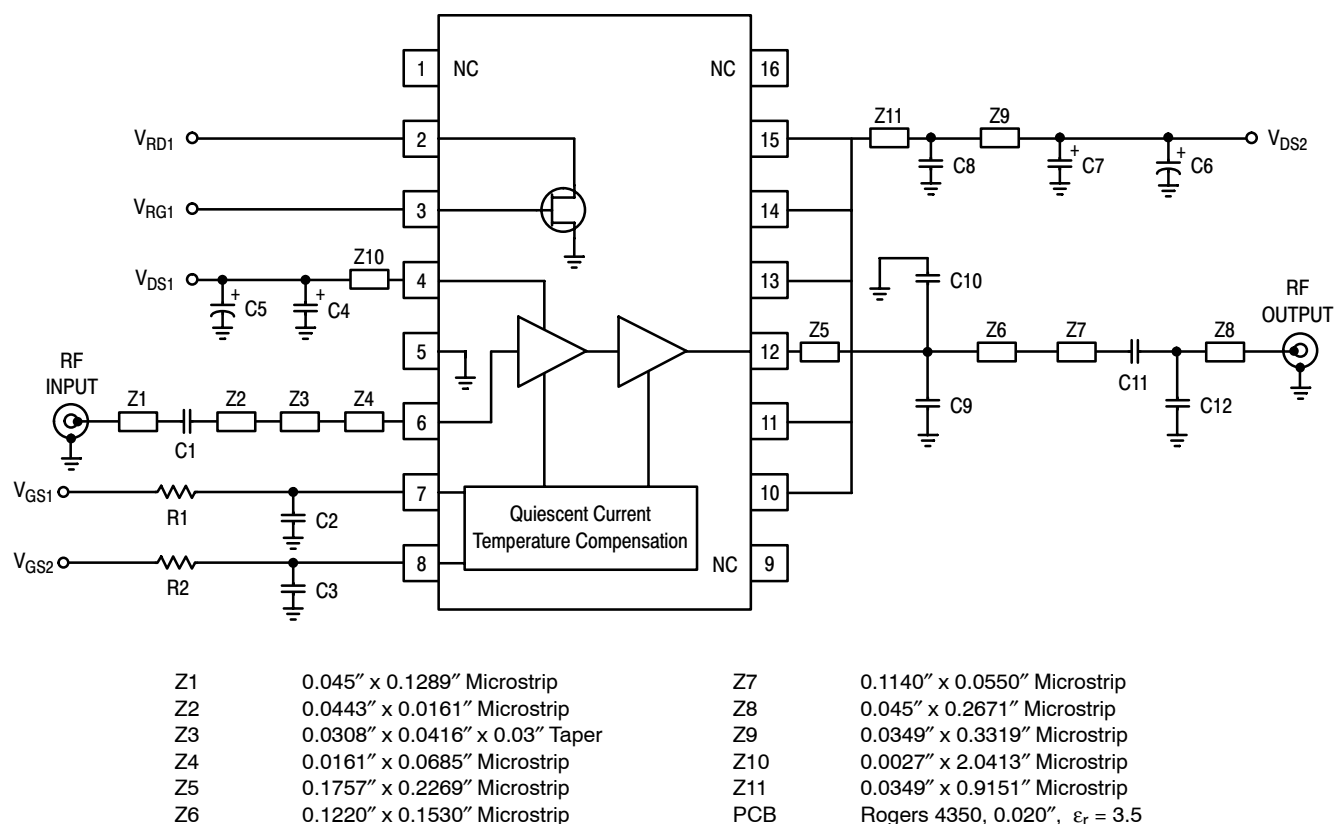

Figure 12. MHV51C2215NR2 Test Circuit Schematic

Table 7. MHV51C2215NR2 Test Circuit Component Designations and Values

Part	Description	Part Number	Manufacturer
C1	22 pF, 25 V Chip Capacitor (0603)	06033J220GBT	AVX
C2, C3	6.8 pF, 50 V Chip Capacitors (0603)	06035J6R8BBT	AVX
C4, C7	1 μ F, 35 V Tantalum Chip Capacitors	TAJA105K035R	Kemet
C5, C6	330 μ F, 50 V Electrolytic Chip Capacitors	MCR35V337M10X16	Multicomp
C8	0.01 μ F, 50 V Chip Capacitor (0805)	0805C103K5RACTR	Vishay
C9, C10	2.4 pF, 50 V Chip Capacitors (0603)	06035J2R4BBT	AVX
C11	15 pF, 25 V Chip Capacitor (0603)	06033J150GBT	AVX
C12	1.5 pF, 50 V Chip Capacitor (0603)	06035J1R5BBT	AVX
R1, R2	1 k Ω Chip Resistors	P1.00KCCT-ND	Panasonic

N-CDMA DRIVER APPLICATION

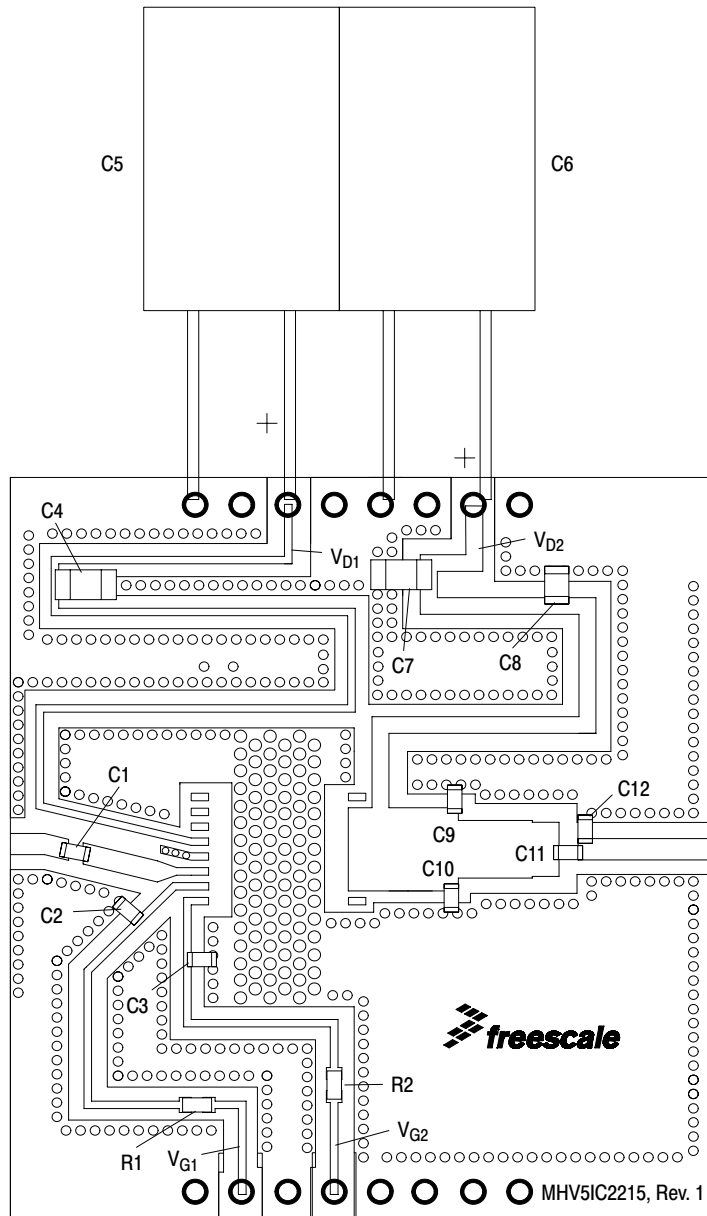

Figure 13. MHV5IC2215NR2 Test Circuit Component Layout

TYPICAL N-CDMA DRIVER APPLICATION CHARACTERISTICS

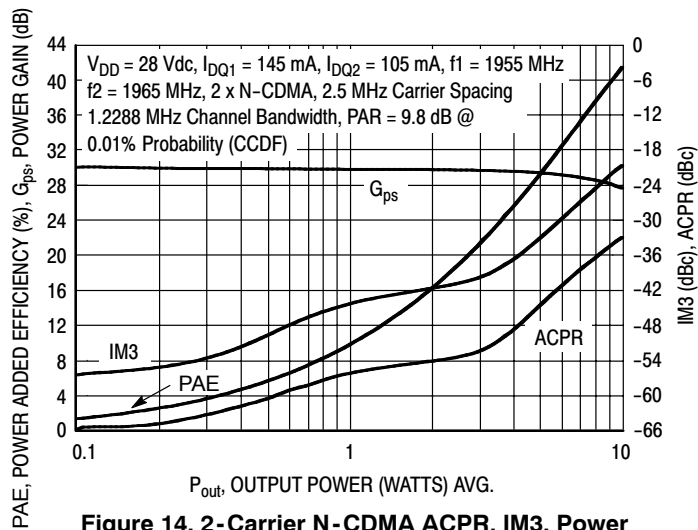

Figure 14. 2-Carrier N-CDMA ACPR, IM3, Power Gain and Power Added Efficiency versus Output Power

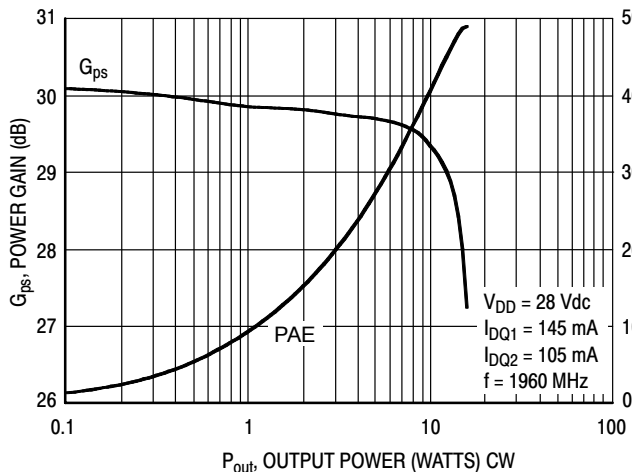

Figure 15. Power Gain and Power Added Efficiency versus Output Power

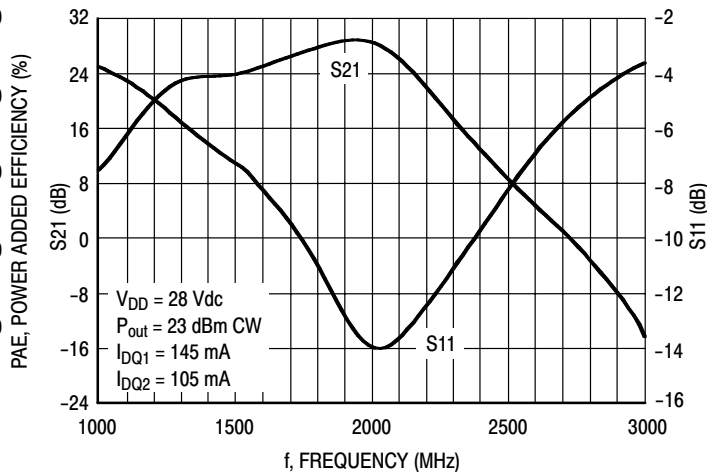
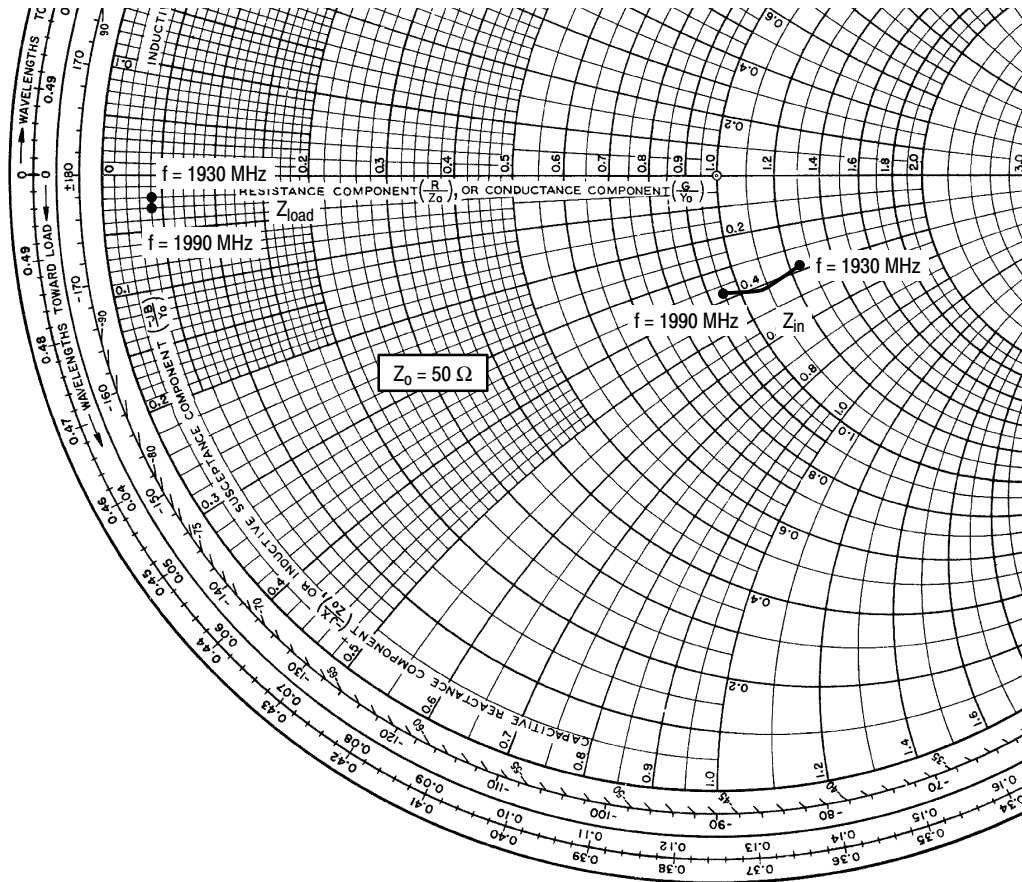

Figure 16. Broadband Frequency Response



$V_{DD} = 28 \text{ Vdc}$, $I_{DQ1} = 164 \text{ mA}$, $I_{DQ2} = 115 \text{ mA}$, $P_{out} = 23 \text{ dBm}$

f MHz	Z_{in} Ω	Z_{load} Ω
1930	$62.3 - j19.4$	$2.18 - j0.88$
1960	$54.1 - j20.7$	$2.15 - j1.18$
1990	$47.4 - j19.3$	$2.12 - j1.49$

Z_{in} = Device input impedance as measured from gate to ground.

Z_{load} = Test circuit impedance as measured from drain to ground.

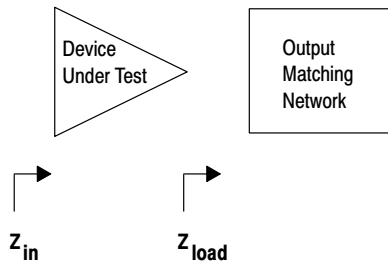

Figure 17. Series Equivalent Input and Load Impedance, 1960 MHz

Table 8. Common Source Scattering Parameters ($V_{DC} = 28\text{ V}$, $T_C = 25^\circ\text{C}$, 50 ohm system)

$I_{DQ1} = 164\text{ mA}$, $I_{DQ2} = 115\text{ mA}$

f MHz	S ₁₁		S ₂₁		S ₁₂		S ₂₂	
	S ₁₁	∠φ	S ₂₁	∠φ	S ₁₂	∠φ	S ₂₂	∠φ
1000	0.68244	21.958	3.27363	-46.706	0.00073	9.794	0.98732	153.093
1200	0.60173	-30.075	10.23125	-119.333	0.00072	13.436	1.00029	126.919
1400	0.47213	-92.332	13.7957	123.921	0.0007	-2.999	0.94139	106.192
1600	0.39882	175.345	13.86577	44.495	0.00088	-45.669	0.93605	87.096
1800	0.35107	59.2	16.61251	-38.246	0.00141	-13.097	0.91624	65.161
2000	0.23689	-70.587	17.30592	-133.04	0.0018	-35.967	0.88891	37.263
2200	0.21492	162.587	17.05916	121.911	0.00324	-62.618	0.56059	-24.504
2400	0.30222	113.328	6.44934	-14.639	0.00275	-134.469	0.69074	84.748
2600	0.46271	74.437	1.40717	-89.824	0.00149	-169.397	0.92384	34.554
2800	0.60247	39.529	0.39763	-141.044	0.00109	167.909	0.958	6.133
3000	0.69273	8.867	0.10191	-174.046	0.00129	122.208	0.9351	-18.125

$I_{DQ1} = 164\text{ mA}$, $I_{DQ2} = 345\text{ mA}$

f MHz	S ₁₁		S ₂₁		S ₁₂		S ₂₂	
	S ₁₁	∠φ	S ₂₁	∠φ	S ₁₂	∠φ	S ₂₂	∠φ
1000	0.67537	21.709	5.31667	-50.942	0.0008	6.129	0.99279	152.416
1200	0.59017	-29.975	15.91709	-129.84	0.00067	-0.12	0.99768	124.892
1400	0.46708	-92.31	19.32081	119.077	0.00075	-10.343	0.91612	105.353
1600	0.39635	174.623	20.10313	41.013	0.00083	-45.427	0.91179	87.084
1800	0.32171	55.947	23.76068	-42.642	0.00135	-6.07	0.89001	65.729
2000	0.2053	-76.58	24.4731	-136.766	0.0017	-34.308	0.86052	38.165
2200	0.20173	154.548	23.13058	117.16	0.00282	-62.743	0.47971	-18.382
2400	0.29085	112.112	8.78893	-12.308	0.00276	-133.95	0.65353	80.165
2600	0.46015	74.095	2.0309	-88.099	0.00145	-172.129	0.91226	34.199
2800	0.60229	39.22	0.58259	-140.332	0.00109	165.352	0.95453	6.049
3000	0.69238	8.662	0.15083	-173.655	0.00114	127.091	0.93394	-18.148

$I_{DQ1} = 164\text{ mA}$, $I_{DQ2} = 500\text{ mA}$

f MHz	S ₁₁		S ₂₁		S ₁₂		S ₂₂	
	S ₁₁	∠φ	S ₂₁	∠φ	S ₁₂	∠φ	S ₂₂	∠φ
1000	0.6711	21.546	5.75013	-53.329	0.0007	24.45	0.99347	152.201
1200	0.58525	-30.018	16.76169	-134.625	0.00077	-1.375	0.9925	124.548
1400	0.46378	-92.504	19.69001	116.925	0.00076	5.296	0.91107	105.394
1600	0.39336	174.232	20.76629	39.298	0.0009	-40.621	0.90699	87.053
1800	0.31114	55.471	24.51619	-44.522	0.00124	-10.794	0.88668	65.947
2000	0.19301	-78.069	25.16732	-138.656	0.00189	-36.619	0.85513	38.413
2200	0.19638	152.604	23.41998	115.327	0.00305	-62.675	0.46723	-15.877
2400	0.28869	111.542	9.01024	-12.58	0.00259	-134.95	0.64185	79.222
2600	0.45971	73.791	2.10623	-88.735	0.00142	-166.566	0.90861	34.114
2800	0.60251	39.001	0.60593	-141.146	0.00107	168.738	0.95346	6.03
3000	0.69282	8.463	0.15674	-174.755	0.00121	124.35	0.93359	-18.226



NOTES

NOTES

PACKAGE DIMENSIONS

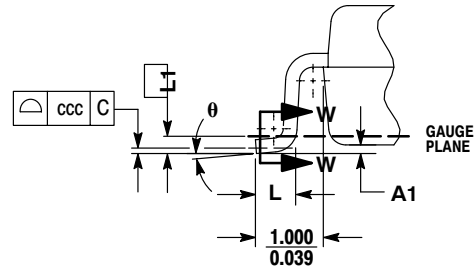
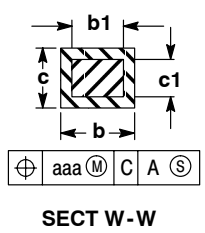
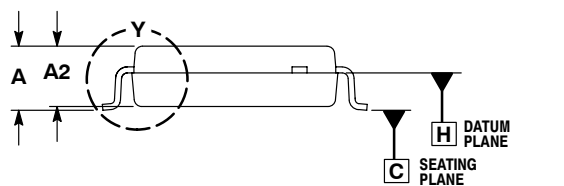
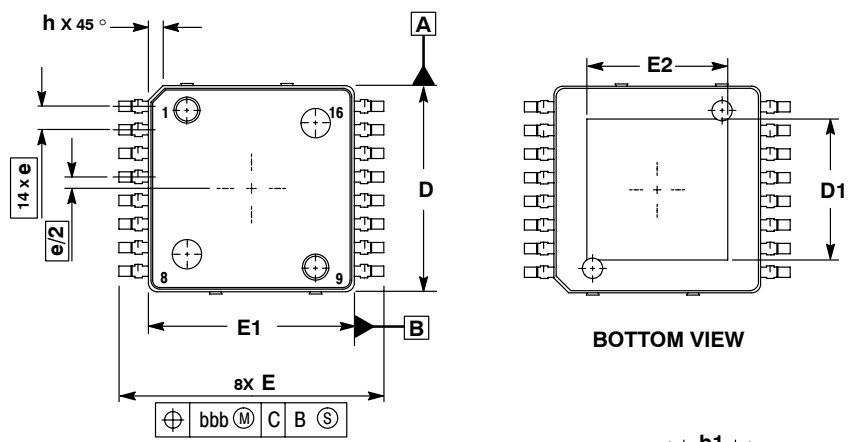

- NOTES:
1. CONTROLLING DIMENSION: MILLIMETER.
 2. DIMENSIONS AND TOLERANCES PER ASME Y14.5M, 1994.
 3. DATUM PLANE -H- IS LOCATED AT BOTTOM OF LEAD AND IS COINCIDENT WITH THE LEAD WHERE THE LEAD EXITS THE PLASTIC BODY AT THE BOTTOM OF THE PARTING LINE.
 4. DIMENSIONS D AND E1 DO NOT INCLUDE MOLD PROTRUSION. ALLOWABLE PROTRUSION IS 0.250 PER SIDE. DIMENSIONS D AND E1 DO INCLUDE MOLD MISMATCH AND ARE DETERMINED AT DATUM PLANE -H-.
 5. DIMENSION b DOES NOT INCLUDE DAMBAR PROTRUSION. ALLOWABLE DAMBAR PROTRUSION IS 0.127 TOTAL IN EXCESS OF THE b DIMENSION AT MAXIMUM MATERIAL CONDITION.
 6. DATUMS -A- AND -B- TO BE DETERMINED AT DATUM PLANE -H-.

DIM	MILLIMETERS	
	MIN	MAX
A	2.000	2.300
A1	0.025	0.100
A2	1.950	2.100
D	6.950	7.100
D1	4.372	5.180
E	8.850	9.150
E1	6.950	7.100
E2	4.372	5.180
L	0.466	0.720
L1	0.250 BSC	
b	0.300	0.432
b1	0.300	0.375
c	0.180	0.279
c1	0.180	0.230
e	0.800 BSC	
h	---	0.600
θ	0°	7°
aaa	0.200	
bbb	0.200	
ccc	0.100	

DETAIL Y

CASE 978-03
 ISSUE C
 PFP-16

How to Reach Us:

Home Page:

www.freescale.com

E-mail:

support@freescale.com

USA/Europe or Locations Not Listed:

Freescale Semiconductor
Technical Information Center, CH370
1300 N. Alma School Road
Chandler, Arizona 85224
+1-800-521-6274 or +1-480-768-2130
support@freescale.com

Europe, Middle East, and Africa:

Freescale Halbleiter Deutschland GmbH
Technical Information Center
Schatzbogen 7
81829 Muenchen, Germany
+44 1296 380 456 (English)
+46 8 52200080 (English)
+49 89 92103 559 (German)
+33 1 69 35 48 48 (French)
support@freescale.com

Japan:

Freescale Semiconductor Japan Ltd.
Headquarters
ARCO Tower 15F
1-8-1, Shimo-Meguro, Meguro-ku,
Tokyo 153-0064
Japan
0120 191014 or +81 3 5437 9125
support.japan@freescale.com

Asia/Pacific:

Freescale Semiconductor Hong Kong Ltd.
Technical Information Center
2 Dai King Street
Tai Po Industrial Estate
Tai Po, N.T., Hong Kong
+800 2666 8080
support.asia@freescale.com

For Literature Requests Only:

Freescale Semiconductor Literature Distribution Center
P.O. Box 5405
Denver, Colorado 80217
1-800-441-2447 or 303-675-2140
Fax: 303-675-2150
LDCForFreescaleSemiconductor@hibbertgroup.com

Information in this document is provided solely to enable system and software implementers to use Freescale Semiconductor products. There are no express or implied copyright licenses granted hereunder to design or fabricate any integrated circuits or integrated circuits based on the information in this document.

Freescale Semiconductor reserves the right to make changes without further notice to any products herein. Freescale Semiconductor makes no warranty, representation or guarantee regarding the suitability of its products for any particular purpose, nor does Freescale Semiconductor assume any liability arising out of the application or use of any product or circuit, and specifically disclaims any and all liability, including without limitation consequential or incidental damages. "Typical" parameters that may be provided in Freescale Semiconductor data sheets and/or specifications can and do vary in different applications and actual performance may vary over time. All operating parameters, including "Typicals", must be validated for each customer application by customer's technical experts. Freescale Semiconductor does not convey any license under its patent rights nor the rights of others. Freescale Semiconductor products are not designed, intended, or authorized for use as components in systems intended for surgical implant into the body, or other applications intended to support or sustain life, or for any other application in which the failure of the Freescale Semiconductor product could create a situation where personal injury or death may occur. Should Buyer purchase or use Freescale Semiconductor products for any such unintended or unauthorized application, Buyer shall indemnify and hold Freescale Semiconductor and its officers, employees, subsidiaries, affiliates, and distributors harmless against all claims, costs, damages, and expenses, and reasonable attorney fees arising out of, directly or indirectly, any claim of personal injury or death associated with such unintended or unauthorized use, even if such claim alleges that Freescale Semiconductor was negligent regarding the design or manufacture of the part.

Freescale™ and the Freescale logo are trademarks of Freescale Semiconductor, Inc. All other product or service names are the property of their respective owners.
© Freescale Semiconductor, Inc. 2006. All rights reserved.

