

PACKAGE DIMENSIONS

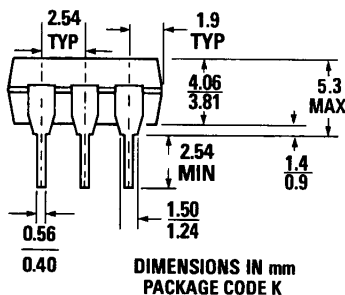

ST1603A

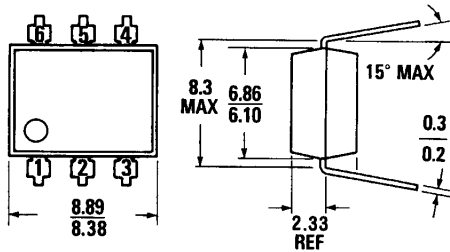
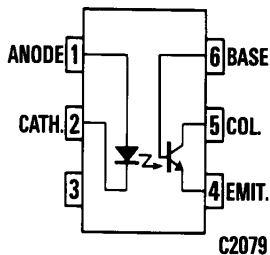

Equivalent Circuit

DESCRIPTION

The MCT-521X are high performance CMOS/LSTTL logic compatible phototransistor type optically coupled isolator products. They are constructed using a very low degradation and high-efficiency AlGaAs, infrared emitter, coupled to a photoefficient high gain NPN phototransistor in a six pin dual-in-line package. This package provides a minimum of 5300 VAC Withstand Test Insulation, and 5000 V/ μ s common mode transient rejection.

The MCT-5211 is well suited for CMOS to LSTT/TTL interfaces, for it offers 250% $CTR_{CE(SAT)}$ with 1 mA of LED input current. When an LED input current of 1.6 mA is supplied data rates to 20K bits/s are possible.

The MCT-5210 can easily interface LSTTL to LSTTL/TTL, and with use of an external base to emitter resistor data rates of 100 K bits/s can be achieved.

FEATURES

- High $CTR_{CE(SAT)}$ comparable to Darlingtons
- CTR guaranteed 0°C to 70°C
- High common mode transient rejection—5 kV/ μ s
- Data rates up to 50 kbits/s (NRZ)
- Underwriters Laboratory (UL) recognized file #E90700

APPLICATIONS

- CMOS to CMOS/LSTTL logic isolation
- LSTTL to CMOS/LSTTL logic isolation
- RS-232 line receiver
- Telephone ring detector
- AC line voltage sensing

ABSOLUTE MAXIMUM RATINGS

TOTAL PACKAGE

Storage temperature	-55°C to 150°C
Operating temperature	-55°C to 100°C
Lead temperature (soldering, 10 sec.)	260°C
Total package power dissipation at 25°C (LED plus detector)	260 mW
Derate linearly from 25°C	3.5 mW/°C

INPUT DIODE

Forward DC current	40 mA
Reverse voltage	6 V
Peak forward current (1 μ s pulse, 300 pps)	1.0 A
Power dissipation	54 mW
Derate linearly from 25°C	0.7 mW/°C

OUTPUT TRANSISTOR

Power dissipation	200 mW
Derate linearly from 25°C	2.67 mW/°C



HIGH PERFORMANCE AlGaAs PHOTOTRANSISTOR OPTOCOUPLERS

INDIVIDUAL COMPONENT CHARACTERISTICS ($T_A=25^\circ\text{C}$ Unless Otherwise Specified)									
CHARACTERISTICS	SYMBOL	MIN	TYP	MAX	UNITS	TEST CONDITIONS	FIG.	NOTE	
INPUT DIODE									
Forward voltage	V_F		1.3	1.5	V	$I_F=5\text{ mA}$		1	
Forward voltage coefficient	$\Delta V_F/\Delta T_A$		-1.9		mV/ $^\circ\text{C}$	$I_F=2\text{ mA}$		1	
Reverse voltage	V_R	5			V	$I_R=10\ \mu\text{A}$			
Junction capacitance	C_J		18		pF	$V_F=0\text{ V}, f=1\text{ MHz}$			
			112		pF	$V_F=1\text{ V}, f=1\text{ MHz}$			
OUTPUT TRANSISTOR									
DC forward current gain	$h_{FE(\text{SAT})}$		350		—	$V_{CE}=0.4\text{ V}, I_{CE}=2\text{ mA}$		8,9	
Breakdown voltage Collector to emitter	BV_{CEO}	30	45		V	$I_C=1.0\text{ mA}, I_E=0$			
Collector to base	BV_{CBO}	30	70		V	$I_C=10\ \mu\text{A}, I_E=0$			
Emitter to base	BV_{EBO}	5	7		V	$I_C=10\ \mu\text{A}, I_E=0$			
Leakage current Collector to emitter	I_{CER}			100	nA	$V_{CE}=10\text{ V}, I_E=0, R_{BE}=1\text{ M}\Omega$			
Capacitance Collector to emitter	C		10		pF	$V_{CE}=0, f=1\text{ MHz}$			
Collector to base			80		pF	$V_{CB}=0, f=1\text{ MHz}$			
Emitter to base			15		pF	$V_{EB}=0, f=1\text{ MHz}$		11	

TRANSFER CHARACTERISTICS OVER RECOMMENDED TEMPERATURE ($T_A=0^\circ\text{C}$ to 70°C Unless Otherwise Specified)									
CHARACTERISTICS	SYMBOL	DEVICE	MIN	TYP*	MAX	UNITS	TEST CONDITIONS	FIG.	NOTE
Saturated current		MCT5210	60	350		%	$I_F=3.0\text{ mA}, V_{CE}=0.4\text{ V}$	2	
Transfer ratio (Collector to emitter)	$CTR_{CE\text{ SAT}}$	MCT5211	100	300		%	$I_F=1.6\text{ mA}, V_{CE}=0.4\text{ V}$	3	1
			75	250		%	$I_F=1.0\text{ mA}, V_{CE}=0.4\text{ V}$		
Current transfer ratio (Collector to emitter)	CTR_{CE}	MCT5210	70	400		%	$I_F=3.0\text{ mA}, V_{CE}=5.0\text{ V}$	5	
		MCT5211	150	350		%	$I_F=1.6\text{ mA}, V_{CE}=5.0\text{ V}$	4	1
			110	300		%	$I_F=1.0\text{ mA}, V_{CE}=5.0\text{ V}$		
Current transfer ratio (Collector to base)	CTR_{CB}	MCT5210	0.2	0.9		%	$I_F=3.0\text{ mA}, V_{CB}=4.3\text{ V}$	6	
		MCT5211	0.3	0.75		%	$I_F=1.6\text{ mA}, V_{CB}=4.3\text{ V}$	7	2
			0.25	0.6		%	$I_F=1.0\text{ mA}, V_{CB}=4.3\text{ V}$		
Saturation voltage (Collector to emitter)	$V_{CE\text{ SAT}}$	MCT5210		0.2	0.4	V	$I_F=3.0\text{ mA}, I_{CE}=1.8\text{ mA}$		
		MCT5211		0.2	0.4	V	$I_F=1.6\text{ mA}, I_{CE}=1.6\text{ mA}$		

*All typicals $T_A=25^\circ\text{C}$



HIGH PERFORMANCE AlGaAs PHOTOTRANSISTOR OPTOCOUPLERS

SWITCHING CHARACTERISTICS ($T_A=25^\circ\text{C}$ Unless Otherwise Specified)										
CHARACTERISTICS	SYMBOL	DEVICE	MIN	TYP	MAX	UNITS	TEST CONDITIONS	FIG.	NOTE	
Propagation delay H-L	t_{PHL}	MCT-5210	10			μS	$R_L=330\ \Omega, R_{BE}=\infty$	$I_F=3.0\ \text{mA}$	12	3
			12			μS	$R_L=3.3\ \text{K}, R_{BE}=39\ \text{K}$	$V_{CC}=5.0\ \text{V}$		
			20			μS	$R_L=750\ \Omega, R_{BE}=\infty$	$I_F=1.6\ \text{mA}$		
			25			μS	$R_L=4.7\ \text{K}, R_{BE}=91\ \text{K}$	$V_{CC}=5.0\ \text{V}$		
			40			μS	$R_L=1.5\ \text{K}, R_{BE}=\infty$	$I_F=1.0\ \text{mA}$		
Propagation delay L-H	t_{PLH}	MCT-5210	10			μS	$R_L=330\ \Omega, R_{BE}=\infty$	$I_F=3.0\ \text{mA}$	12	4
			12			μS	$R_L=3.3\ \text{K}, R_{BE}=39\ \text{K}$	$V_{CC}=5.0\ \text{V}$		
			20			μS	$R_L=750\ \Omega, R_{BE}=\infty$	$I_F=1.6\ \text{mA}$		
			25			μS	$R_L=4.7\ \text{K}, R_{BE}=91\ \text{K}$	$V_{CC}=5.0\ \text{V}$		
			40			μS	$R_L=1.5\ \text{K}, R_{BE}=\infty$	$I_F=1.0\ \text{mA}$		
			45			μS	$R_L=10\ \text{K}, R_{BE}=160\ \text{K}$	$V_{CC}=5.0\ \text{V}$		

ISOLATION CHARACTERISTICS ($T_A=0^\circ\text{C}$ Unless Otherwise Specified)								
CHARACTERISTICS	SYMBOL	MIN	TYP	MAX	UNITS	TEST CONDITIONS	FIG.	NOTE
Common mode transient Rejection - output high	CM_H		5000		$\text{V}/\mu\text{S}$	$V_{CM}=50\ \text{V}_{p-p}, R_L=750\ \Omega$ $I_F=0$	14	
Common mode transient Rejection - output low	CM_L		5000		$\text{V}/\mu\text{S}$	$V_{CM}=50\ \text{V}_{p-p}, R_L=750\ \Omega$ $I_F=1.6\ \text{mA}$		
Common mode coupling capacitor	C_{CM}		0.2		pF		14	5
Package capacitance input/output	$C_{I/O}$		0.7		pF	$V_{I/O}=0, f=1\ \text{MHz}$		6
Withstand insulation test voltage	V_{ISO}	5300			$V_{AC(RMS)}$	$I_{I/O} \leq 1\ \mu\text{A}, 1\ \text{minute}$		7
	V_{ISO}	7500			$V_{AC(Peak)}$			
Insulation resistance	R_{ISO}	10^{11}			Ohms	$V_{I/O}=500\ \text{V}$		

NOTES

1. DC Current Transfer Ratio (CTR_{CE}) is defined as the transistor collector current (I_{CE}) divided by the input LED current (I_F) x 100%, at a specified voltage between the collector and emitter (V_{CE}).
2. The collector base Current Transfer Ratio (CTR_{CB}) is defined as the collector base photocurrent (I_{CB}) divided by the input LED current (I_F) time 100%.
3. Referring to Figure 13 the t_{PHL} propagation delay is measured from the rising edge of the data input (A) to the rising edge of the rising edge of the data output (B).
4. Referring to Figure 13 the t_{PLH} propagation delay is measured from the falling edge of data input (A) to the falling edge of the data output (B).
5. C_{CM} is the capacitance between the LED (input assembly) to the base of the phototransistor.
6. $C_{I/O}$ is the capacitance between the input (pins 1, 2, 3 connected) and the output, (pins 4, 5, 6 connected).
7. Device considered a two terminal device: Pins 1, 2, and 3 shorted together, and pins 5, 6, and 7 are shorted together.

TYPICAL ELECTRO-OPTICAL CHARACTERISTICS ($T_A=25^\circ\text{C}$ Unless Otherwise Specified)

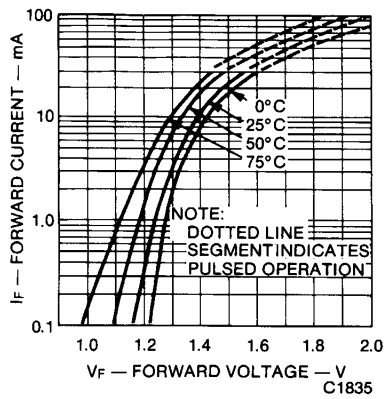

Fig. 1. Forward Voltage vs. Forward Current

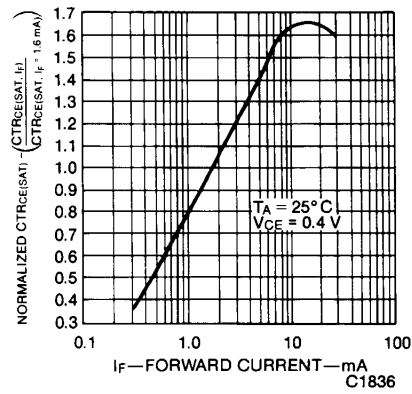

Fig. 2. Normalized Current Transfer Ratio vs. Forward Current

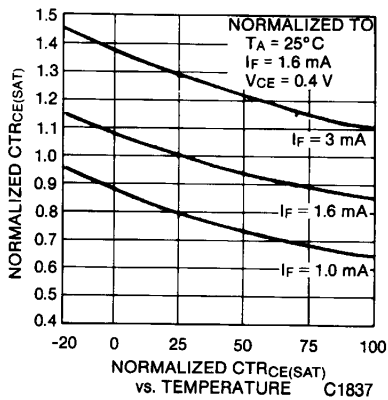

Fig. 3. Normalized CTR vs. Temperature

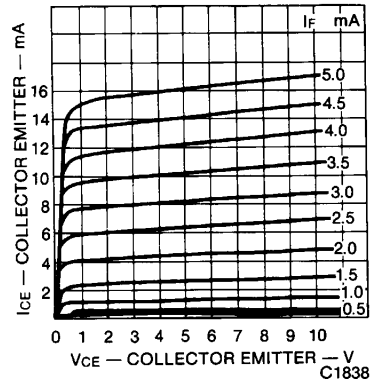

Fig. 4. DC Characteristics MCT5210

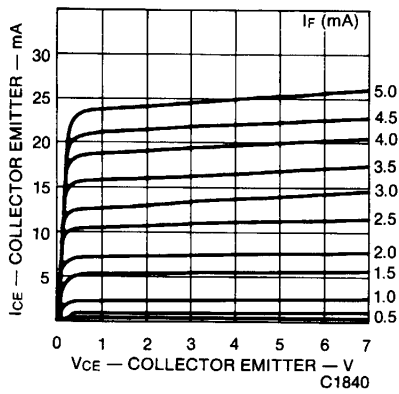

Fig. 5. DC Characteristics MCT5211

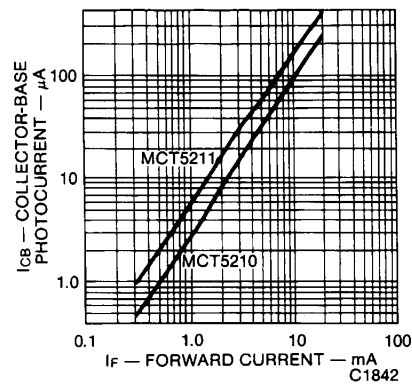

Fig. 6. Collector Base Photocurrent vs. Forward Current

TYPICAL ELECTRO-OPTICAL CHARACTERISTICS

($T_A = 25^\circ\text{C}$ Unless Otherwise Specified) (Cont'd)

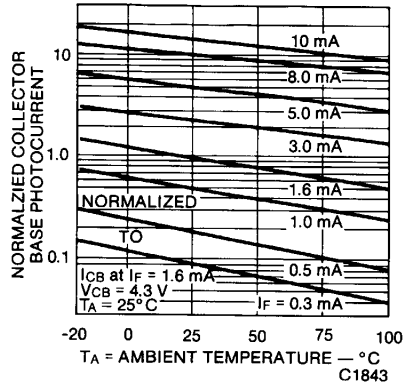

Fig. 7. Normalized Collector Base Photocurrent vs. Temperature

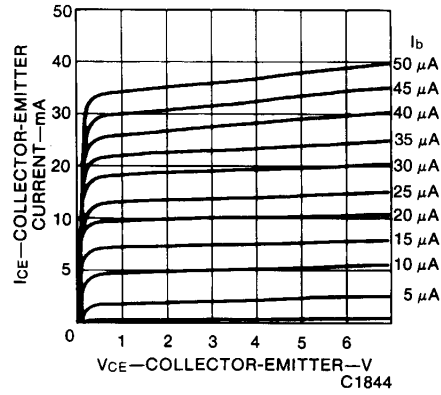

Fig. 8. Transistor DC Characteristics

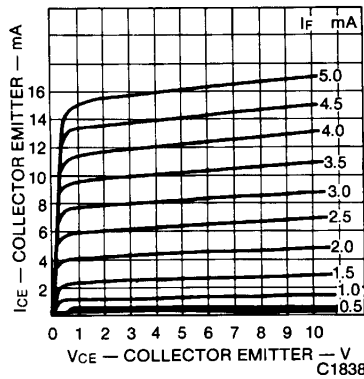

Fig. 9. $h_{FE(SAT)}$ vs. I_b vs. Temperature

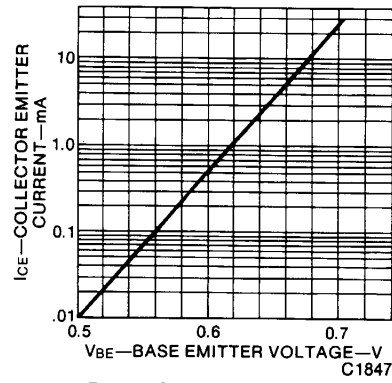

Fig. 10. Collector Current vs. Base Emitter Voltage

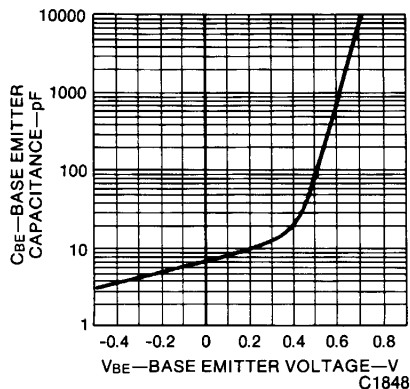

Fig. 11. C_{BE} vs. V_{BE}

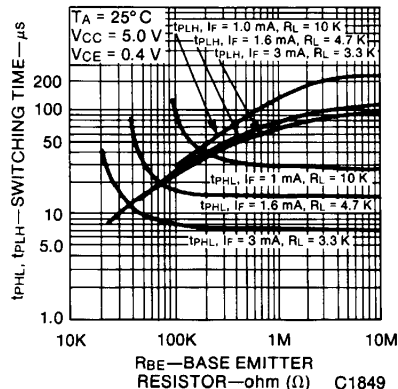
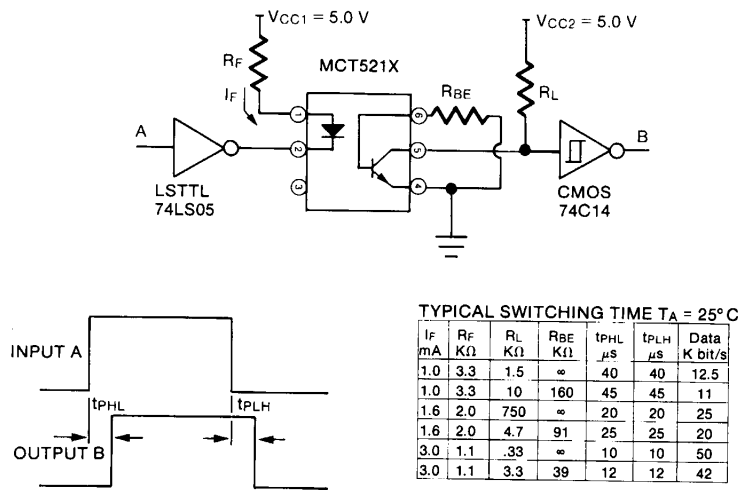

Fig. 12. Switching Time vs. R_{BE}

TYPICAL ELECTRO-OPTICAL CHARACTERISTICS

($T_A = 25^\circ\text{C}$ Unless Otherwise Specified) (Cont'd)



TYPICAL SWITCHING TIME $T_A = 25^\circ\text{C}$

I_F mA	R_F K Ω	R_L K Ω	R_{BE} K Ω	t_{PHL} μs	t_{PLH} μs	Data K bit/s
1.0	3.3	1.5	∞	40	40	12.5
1.0	3.3	10	160	45	45	11
1.6	2.0	750	∞	20	20	25
1.6	2.0	4.7	91	25	25	20
3.0	1.1	.33	∞	10	10	50
3.0	1.1	3.3	39	12	12	42

C1850

Fig. 13. Switching Speed Test Circuit

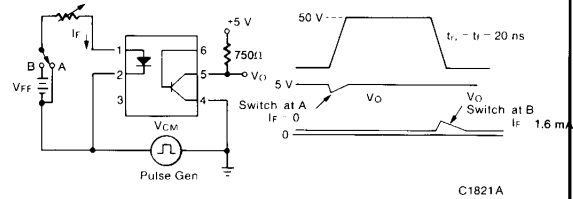
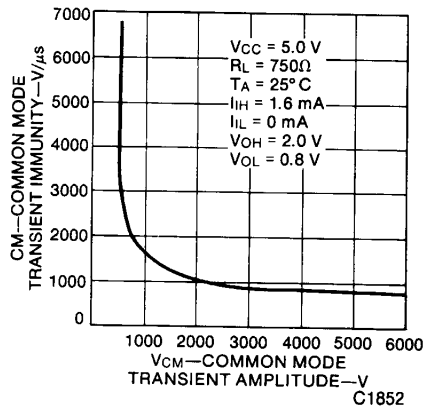

C1821A

Fig. 14. Common Mode Transient Rejection & Test Circuit