

$I_{F(AV)} = 0.5\text{Amp}$
 $V_R = 20\text{V}$

Major Ratings and Characteristics

Characteristics	Value	Units
$I_{F(AV)}$ (DC)	0.5	A
V_{RRM}	20	V
I_{FSM} @ $t_p = 10\text{ms}$ sine	6.5	A
V_F @ 0.5Apk , $T_J = 100^\circ\text{C}$	0.36	V
T_J range	- 65 to 150	$^\circ\text{C}$

Description/ Features

This Schottky diode is ideally suited for low voltage, high frequency operation, as freewheeling and polarity protection. Small size of the package allows proper use in application where compact size is critical, fitting also the GSM and PCMCIA requirement.

- Surface mountable
- Very low forward voltage drop
- Extremely fast switching
- Negligible switching losses
- Guard ring for enhanced ruggedness and long term reliability
- Lead-Free ("PbF" suffix)

Case Styles

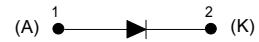

SOD123

Voltage Ratings

Part number	Value
V _R Max. DC Reverse Voltage (V)	20
V _{RWM} Max. Working Peak Reverse Voltage (V)	

Absolute Maximum Ratings

Parameters	Value	Units	Conditions
I _F Max. Average Forward Current	0.5	A	DC, T _L = 129°C
I _{FSM} Max. Peak One Cycle Non-Repetitive Surge Current, @ 25°C	55	A	5µs Sine or 3µs Rect. pulse
	6.5	A	10ms Sine or 6ms Rect. pulse

Following any rated load condition and with rated V_{RRM} applied

Electrical Specifications

Parameters	Value	Units	Conditions
V _{FM} Max. Forward Voltage Drop (1)	0.375	V	@ 0.1A
	0.440	V	@ 0.5A
V _{FM} Max. Forward Voltage Drop (1)	0.260	V	@ 0.1A
	0.360	V	@ 0.5A
I _{RM} Max. Reverse Leakage Current	40	µA	T _J = 25°C
	3	mA	T _J = 100°C
	150	µA	T _J = 25°C
	7	mA	T _J = 100°C
C _T Max. Junction Capacitance	110	pF	V _R = 5V _{DC} (test signal range 100KHz to 1Mhz), T _J = 25°C
dv/dt Max. Voltage Rate of Change (Rated V _R)	10000	V/µs	

(1) Pulse Width < 300µs, Duty Cycle < 2%

Thermal-Mechanical Specifications

Parameters	Value	Units	Conditions
T _J Max. Junction Temperature Range(*)	-65 to 150	°C	
T _{stg} Max. Storage Temperature Range	-65 to 150	°C	
R _{thJL} Max. Thermal Resistance Junction to Lead	150	°C/W	Mounted on PC board FR4 with minimum pad size
R _{thJA} Max. Thermal Resistance Junction to Ambient	200	°C/W	1 inch square pad size (1 x 0.5 inch for each lead) on FR4 board
Wt Approximate Weight	0.012	gr	
Case Style	SOD123		
Device Marking	A _Y WLC		

(*) $\frac{dP_{tot}}{dT_j} < \frac{1}{R_{th(j-a)}}$ thermal runaway condition for a diode on its own heatsink

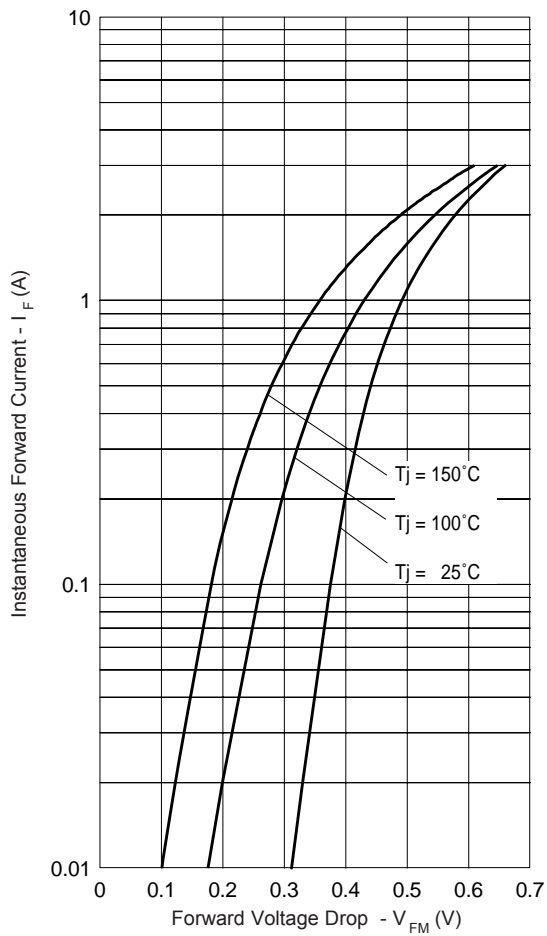

Fig. 1 - Maximum Forward Voltage Drop Characteristics

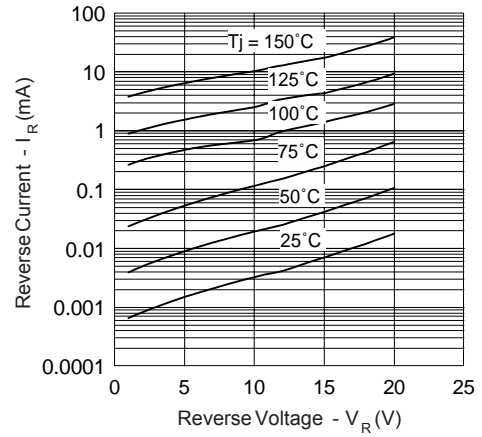

Fig. 2 - Typical Values of Reverse Current Vs. Reverse Voltage

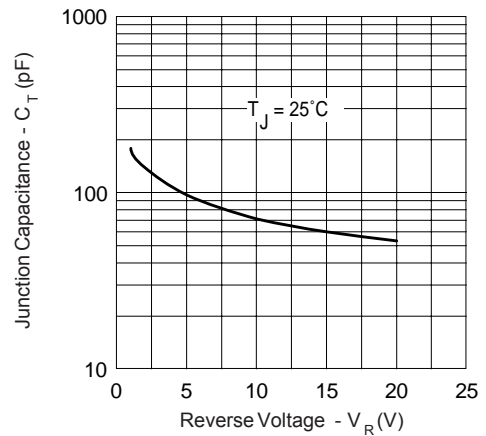

Fig. 3 - Typical Junction Capacitance Vs. Reverse Voltage

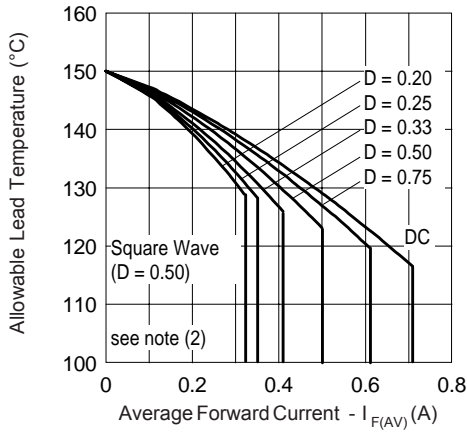

Fig. 5 - Maximum Allowable Case Temperature Vs. Average Forward Current

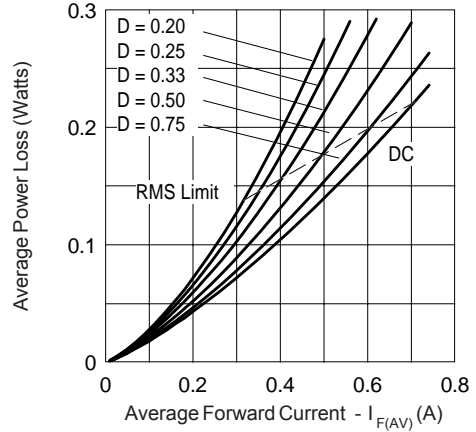

Fig. 6 - Forward Power Loss Characteristics

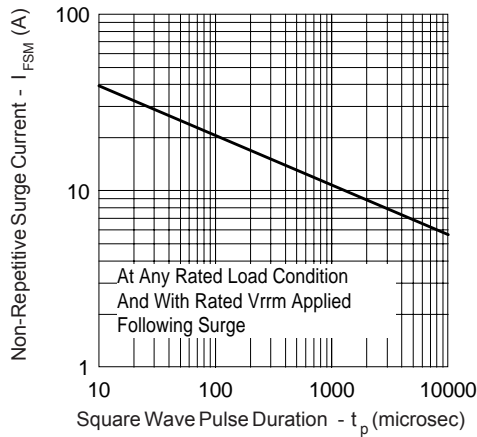
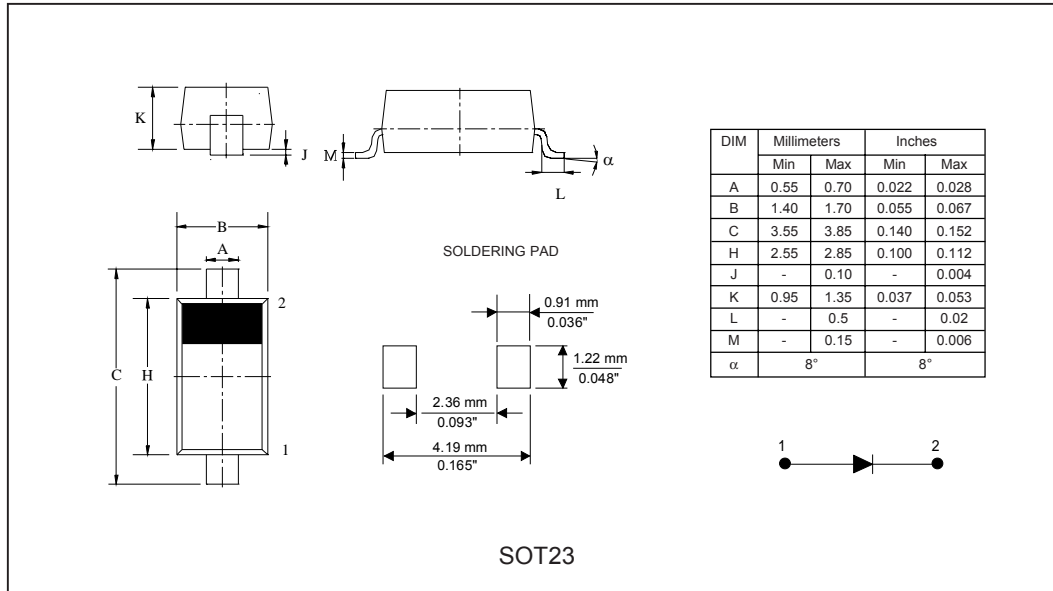

Fig. 7 - Maximum Non-Repetitive Surge Current

(2) Formula used: $T_C = T_J - (Pd + Pd_{REV}) \times R_{thJC}$;
 $Pd = \text{Forward Power Loss} = I_{F(AV)} \times V_{FM} @ (I_{F(AV)} / D)$ (see Fig. 6);
 $Pd_{REV} = \text{Inverse Power Loss} = V_{R1} \times I_R (1 - D)$

Outline Table



Tape & Reel Information

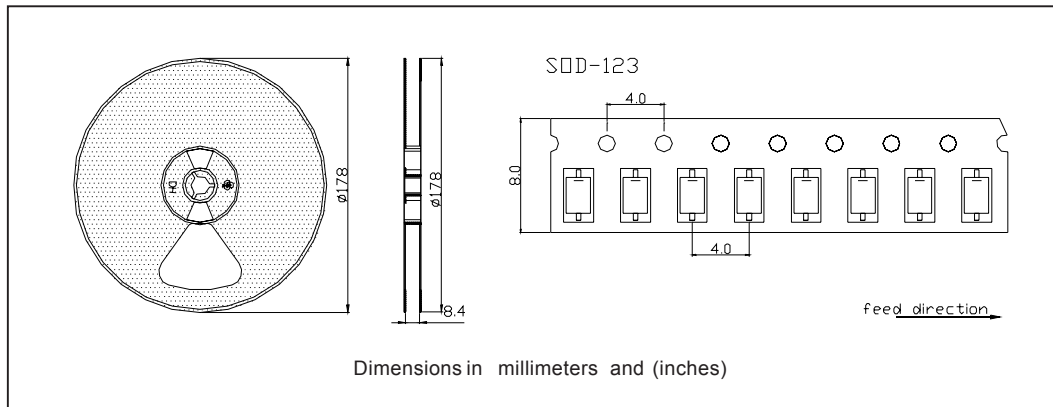

Ordering Information Table

Device	Package	Marking	Base qty	Delivery mode
MBR0520	SOD-123	AYWLC	3000	Tape & Reel

MBR0520PbF

Bulletin PD-21131 rev. A 08/06

International
IOR Rectifier

Data and specifications subject to change without notice.
This product has been designed and qualified for Industrial Level and Lead-Free.
Qualification Standards can be found on IR's Web site.

International
IOR Rectifier

IR WORLD HEADQUARTERS: 233 Kansas St., El Segundo, California 90245, USA Tel: (310) 252-7105
TAC Fax: (310) 252-7309
Visit us at www.irf.com for sales contact information. 08/06