

SHARP

LZ244D

Low-Voltage (5 V/12 V) Operation 1/4-type
Color CCD Area Sensor with 220k Square Pixels

■ Description

LZ244D is a 1/4-type (4.5 mm) solid state imaging device consisting of PN photo-diodes and CCDs (charge-coupled devices) driven by only positive voltages.

Having about 220 000 pixels (Horizontal 384×Vertical 582), it allows a stable color image to be obtained at high resolution.

■ Features

1. Low-voltage (5 V/12 V) operation
2. Number of video picture elements
: Horizontal 362×Vertical 582
Pixel pitch : Horizontal 13.6 μm ×Vertical 6.3 μm
Number of optically black pixel
: Horizontal; front 2 and rear 20
3. Complementary color filters of Mg, G, Cy, and Ye
4. Built-in overflow drain voltage output circuit, and built-in reset gate bias output circuit
5. Reduced fixed pattern noise and lag
6. No sticking and no image distortion
7. Blooming suppression structure
8. Built-in output amplifier, voltage generator, pulse mix circuit
9. Variable electronic shutter
10. Package
14-pin WDIP[Plastic](WDIP014-P-0400A)

■ Pin Connections

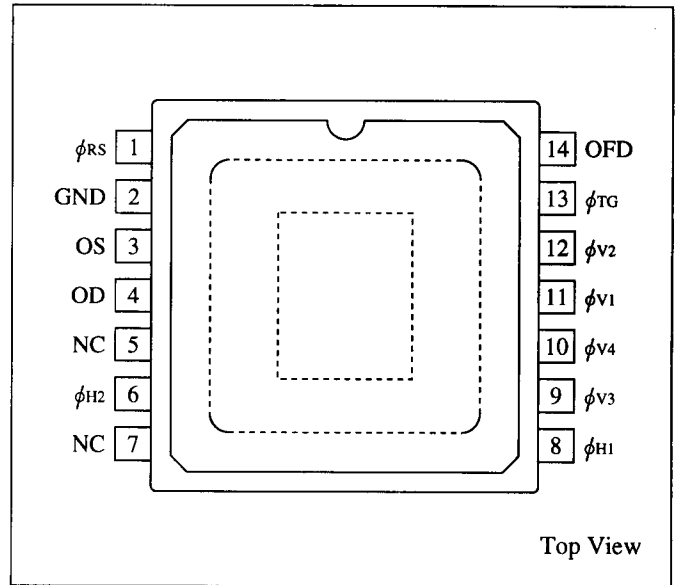

■ Pin Description

No.	Symbol	Pin name	Note
1	ϕ_{RS}	Reset transistor gate clock	1
2	GND	Ground	
3	OS	Video output	
4	OD	Output transistor drain	
5	NC	No connection	
6	ϕ_{H2}	Horizontal shift resistor clock	
7	NC	No connection	
8	ϕ_{H1}	Horizontal Shift resistor clock	
9	ϕ_{V3}	Vertical shift resistor clock	2
10	ϕ_{V4}	Vertical shift resistor clock	
11	ϕ_{V1}	Vertical shift resistor clock	
12	ϕ_{V2}	Vertical shift resistor clock	
13	ϕ_{TG}	Transfer gate clock	3
14	OFD	Overflow drain	1

Note 1. ϕ_{RS} , OFD : Use the circuit parameter indicated in "System Configuration Example (P.7)", and do not connect to DC voltage directly.

When not using electrical shutter, connect OFD to GND through a 0.1 μF capacitor and a 1 m Ω resistor.

Note 2. ϕ_{V1} - ϕ_{V4} : Input the clock through a 0.1 μF capacitor.

Note 3. ϕ_{TG} : Use the circuit parameter indicated in "System Configuration Example (P.7)"

Absolute Maximum Rating

(Ta=25 °C)

Parameter	Symbol	Rating	Unit	Note
Output transistor drain voltage	V _{OD}	0 to +15	V	
Reset gate clock voltage	V ϕ _{RS}	(Internal output)	V	1
Vertical shift register clock voltage	V ϕ _V	0 to +7.5	V	
Horizontal shift register clock voltage	V ϕ _H	-0.3 to +7.5	V	
Transfer gate clock voltage	V ϕ _{TG}	-0.3 to +15	V	
Overflow drain voltage	V _{OFD}	(Internal output)	V	2
Storage temperature	T _{stg}	-40 to +85	°C	
Operating ambient temperature	T _{opr}	-20 to +70	°C	

Note 1. Do not connect to DC voltage directly. When ϕ RS is connected to GND, connect V_{OD} to GND. Reset gate clock is applied below 8 V_{p-p}.

Note 2. Do not connect to DC voltage directly. When OFD is connected to GND, connect V_{OD} to GND. Overflow drain clock is applied below 13 V_{p-p}.

Recommended Operating Conditions

Parameter		Symbol	MIN.	TYP.	MAX.	Unit	Note
Operating ambient temperature		T _{opr}		25		°C	
Output transistor drain voltage		V _{OD}	12	12.5	13	V	
Overflow drain clock	P-P level	V ϕ _{OFD}	12	12.5	13	V	1
Ground voltage		GND		0		V	
Transfer gate clock	LOW level	V ϕ _{TGL}	-0.05	0	0.05	V	
	HIGH level	V ϕ _{TGH}	12	12.5	13	V	
Vertical shift register clock	P-P level	V ϕ _{V1} , V ϕ _{V2} , V ϕ _{V3} , V ϕ _{V4}	4.7	5.0	5.5	V	2
Horizontal shift register clock	LOW level	V ϕ _{H1L} , V ϕ _{H2L}	-0.05	0	0.05	V	
	HIGH level	V ϕ _{H1H} , V ϕ _{H2H}	4.7	5.0	5.5	V	
Reset gate clock	P-P level	V ϕ _{RS}	4.5	5.0	5.5	V	3
Vertical shift register clock frequency		f ϕ _{V1} , f ϕ _{V2} , f ϕ _{V3} , f ϕ _{V4}		15.63		kHz	
Horizontal shift register clock frequency		f ϕ _{H1} , f ϕ _{H2}		6.75		MHz	
Reset gate clock frequency		f ϕ _{RS}		6.75		MHz	

Note 1. OFD : Use the circuit parameter indicated in "System Configuration Example (P.7)", and do not connect to DC voltage directly.

Note 2. ϕ V1 - ϕ V4 : Use the circuit parameter indicated in "System Configuration Example (P.7)", and do not connect to DC voltage directly.

Note 3. ϕ RS : Use the circuit parameter indicated in "System Configuration Example (P.7)", and do not connect to DC voltage directly.

※ To apply power, first connect GND and then turn on V_{OD} and then turn on other powers and pulses.

Do not connect the device to or disconnect it from the plug socket while power is being applied.

■ Electrical Characteristics

- Drive method : Field accumulation
- DC and AC conditions : The typical values under the recommended operating conditions.
- Ambient temperature : 25 °C
- Temperature of light source : 3 200 K
- Infrared absorbing filter (CM-500,1 mm) is used.

Parameter	Symbol	MIN.	TYP.	MAX.	Unit	Note
Standard output voltage	V _o		150		mV	2
Photo response non-uniformity	PRNU			15	%	3
Saturation output voltage	V _{sat}	550			mV	4
Dark output voltage	V _{dark}		0.5		mV	1, 5
Dark signal non-uniformity	DSNU		0.5		mV	1, 6
Sensitivity	R		400		mV	7
Smear ratio	SMR		-85		dB	8
Image lag	AI			1.0	%	9
Blooming suppression ratio	ABL	1000				10
Current dissipation	I _{OD}		4.0	8.0	mA	
Output impedance	R _o		400		Ω	
Vector breakup				10	°, %	11
Line crawling				3.0	%	12
Luminance flicker				2.0	%	1, 13

Note 1. Ta=60 °C

Note 2. The standard output voltage is defined as 150 mV by the average output voltage under uniform illumination.

Note 3. The image area is divided into 10×10 segments. The voltage of a segment is the average of output voltage from all the pixels within the segment.

PRNU is defined by $(V_{max} - V_{min}) / V_o$, where V_{max} and V_{min} are the maximum and the minimum values of each segment's voltage respectively, when the average output voltage V_o is 150 mV.

Note 4. The image area is divided into 10×10 segments. The saturation signal is defined as the minimum of each segment's voltage which is the average of output voltage from all the pixels within the segment, when the exposure level is set as 10 times, compared to standard level.

Note 5. The average output voltage under a non-exposure condition.

Note 6. The image area is divided into 10×10 segments.

DSNU is defined by $(V_{dmax} - V_{dmin})$ under the non-exposure condition where V_{dmax} and V_{dmin} are the maximum and the minimum values of each segment's voltage, respectively, that is the average output voltage over all pixels in the segment.

Note 7. The average output voltage when a 1000 lux light source attached with a 90% reflector is imaged by a lens of F4, f50 mm.

Note 8. The sensor is adjusted to position a V/10 square at the center of image area where V is the vertical length of the image area. SMR is defined by the ratio of the output voltage detected during the vertical blanking period to the maximum of the pixel voltage in the V/10 square.

Note 9. The sensor is exposed at the exposure level corresponding to the standard condition preceding non-exposure condition. AI is defined by the ratio between the output voltage measured at the 1st field during the non-exposure period and the standard output voltage.

Note 10. The sensor is adjusted to position a V/10 square at the center of image area.

ABL is the ratio between the exposure at the standard condition and the exposure at a point where a blooming is observed.

Note 11. Observed with a vector scope when the color bar chart is imaged under the standard exposure condition.

Note 12. The difference between the average output voltage of the (Mg + Ye), (G + Cy) line and the (Mg + Cy), (G + Ye) line under the standard exposure condition.

Note 13. The difference between the average output voltage of the odd field and the even field.

※ Within the recommended operating condition of V_{OD}, V_{OFD} of the internal output satisfy with ABL larger than 1000 times exposure of the standard exposure condition, and V_{sat} larger than 450 mV.

■ Composition of Pixels and Arrangement of Color Filters

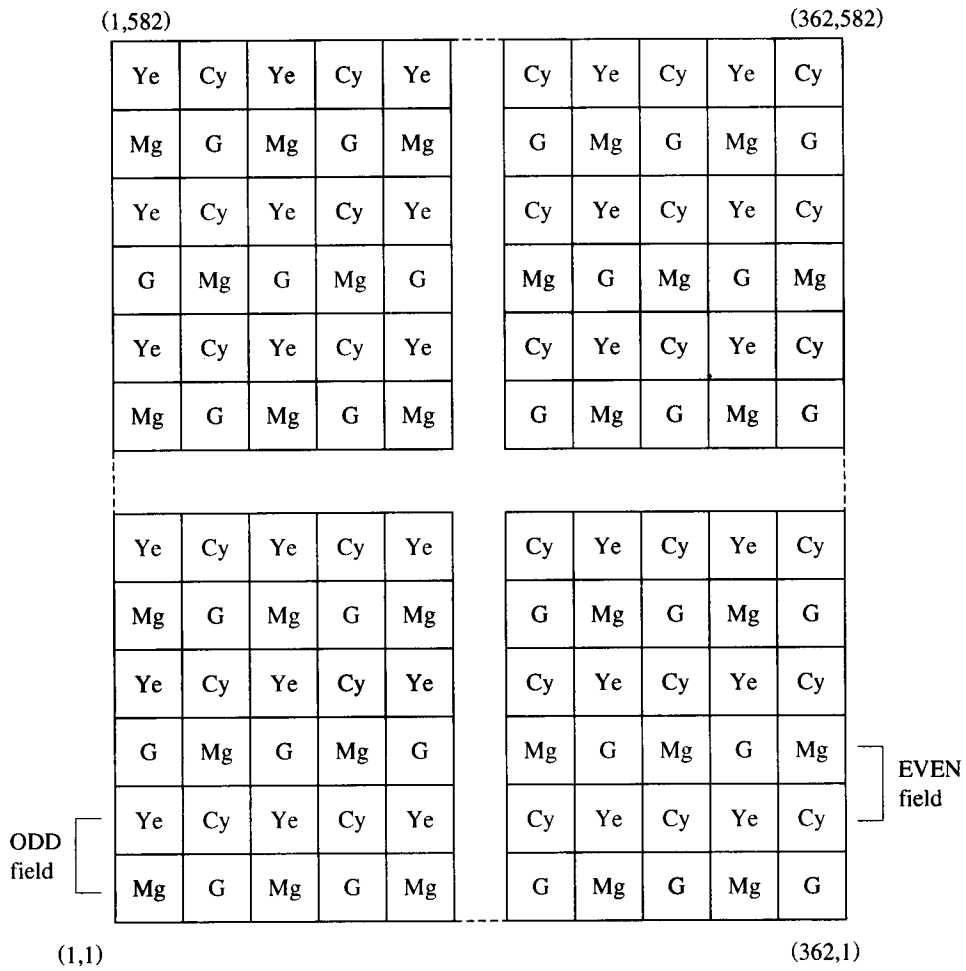
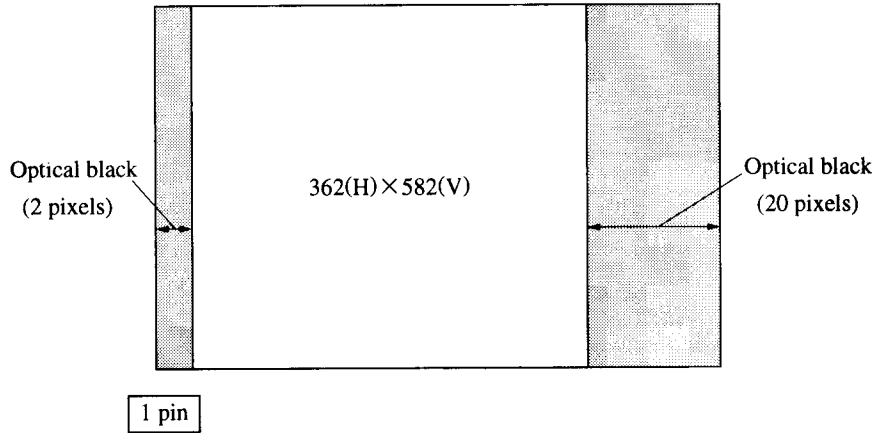

■ Timing Diagram

(1) Vertical Transfer Timing

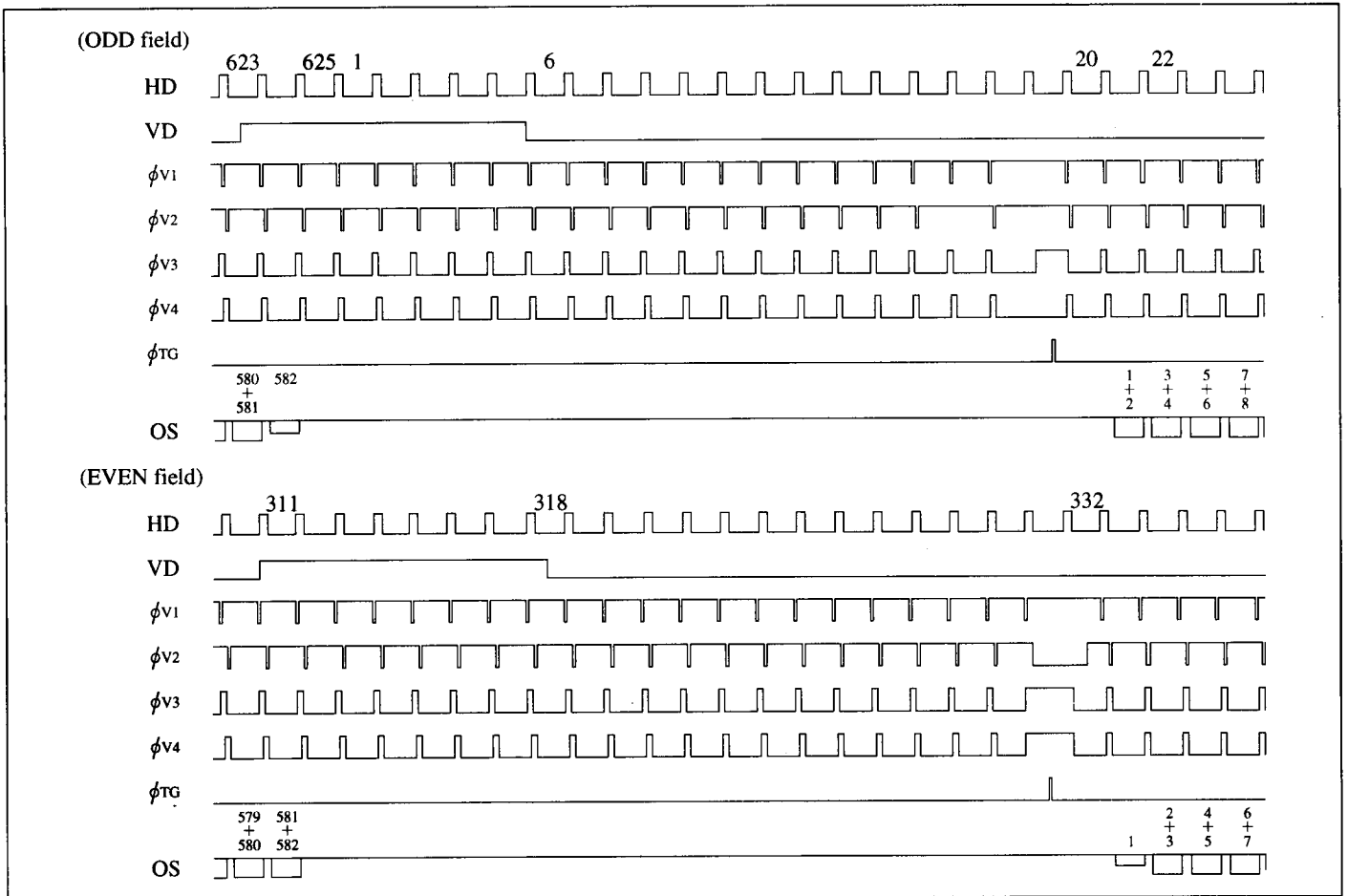

(2) Horizontal Transfer Timing

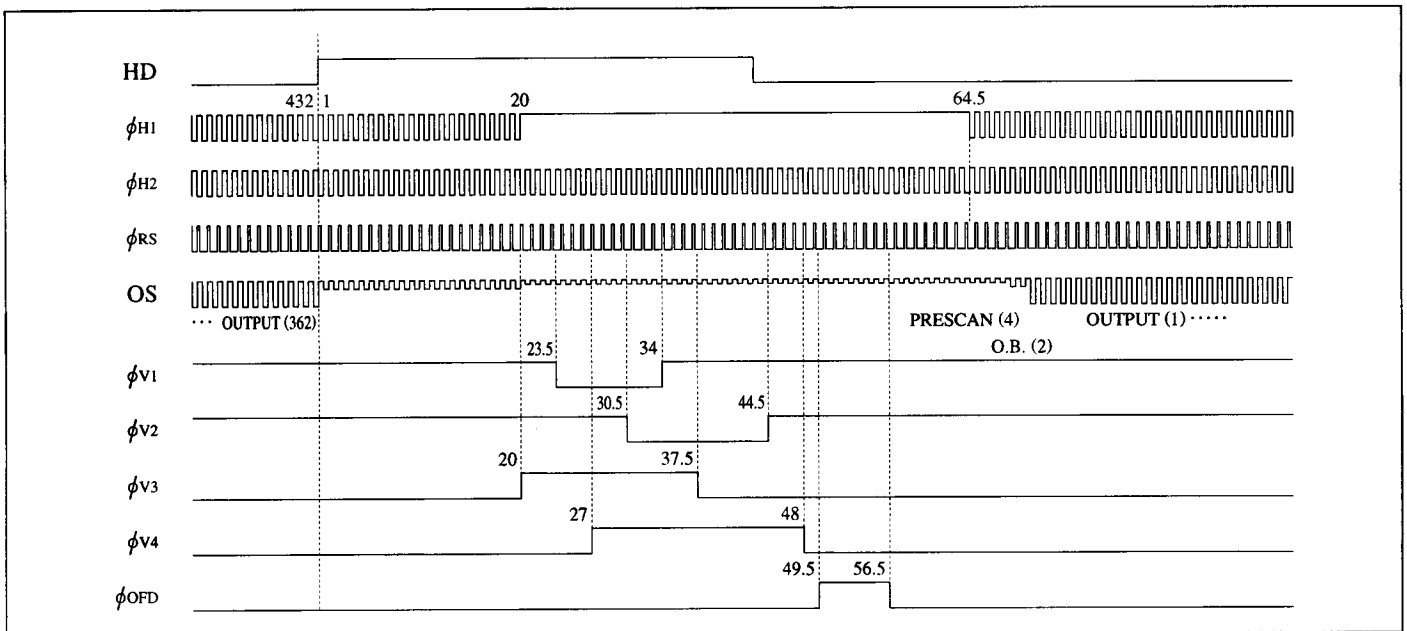

(3) Read Out Timing

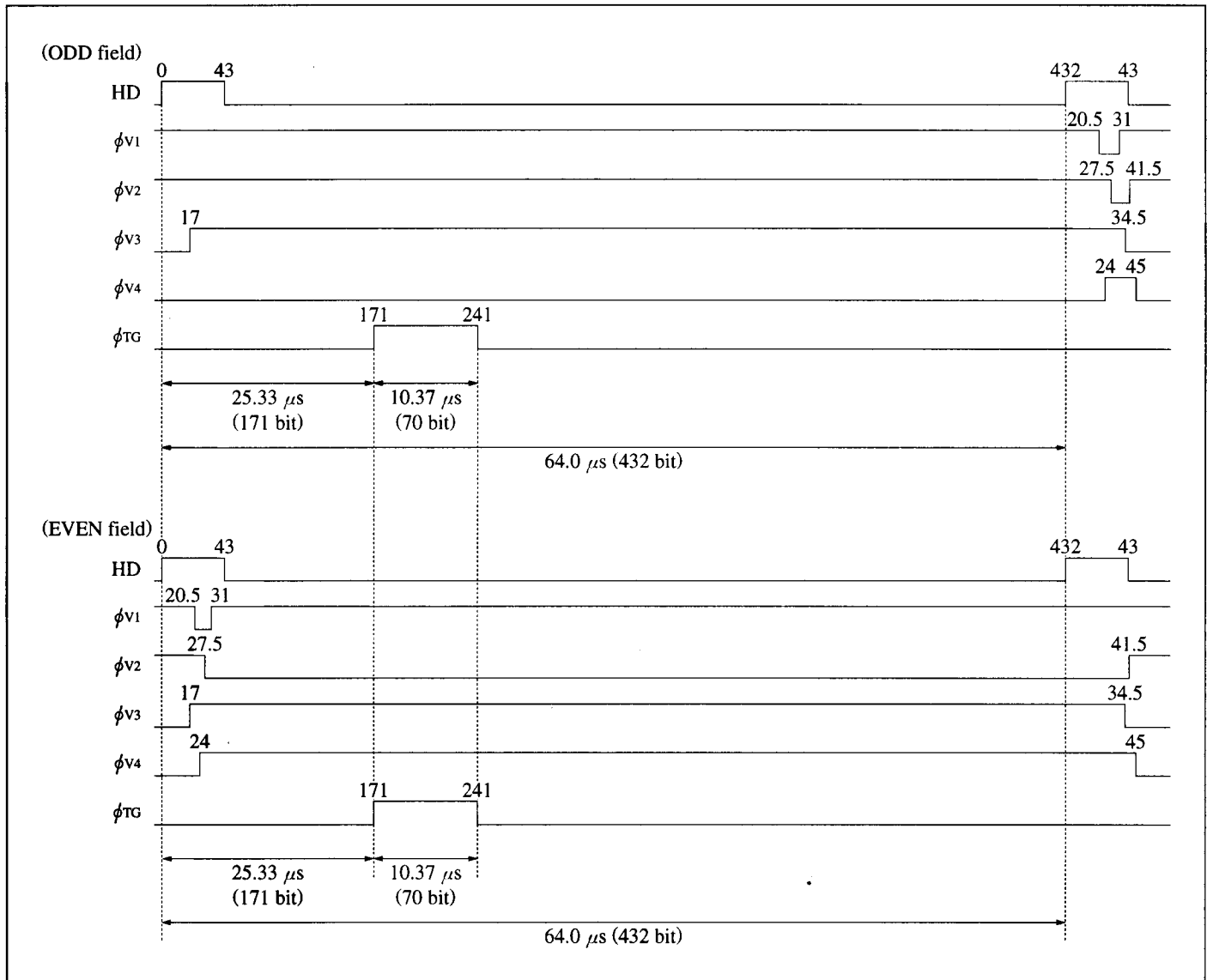

System Configuration Example

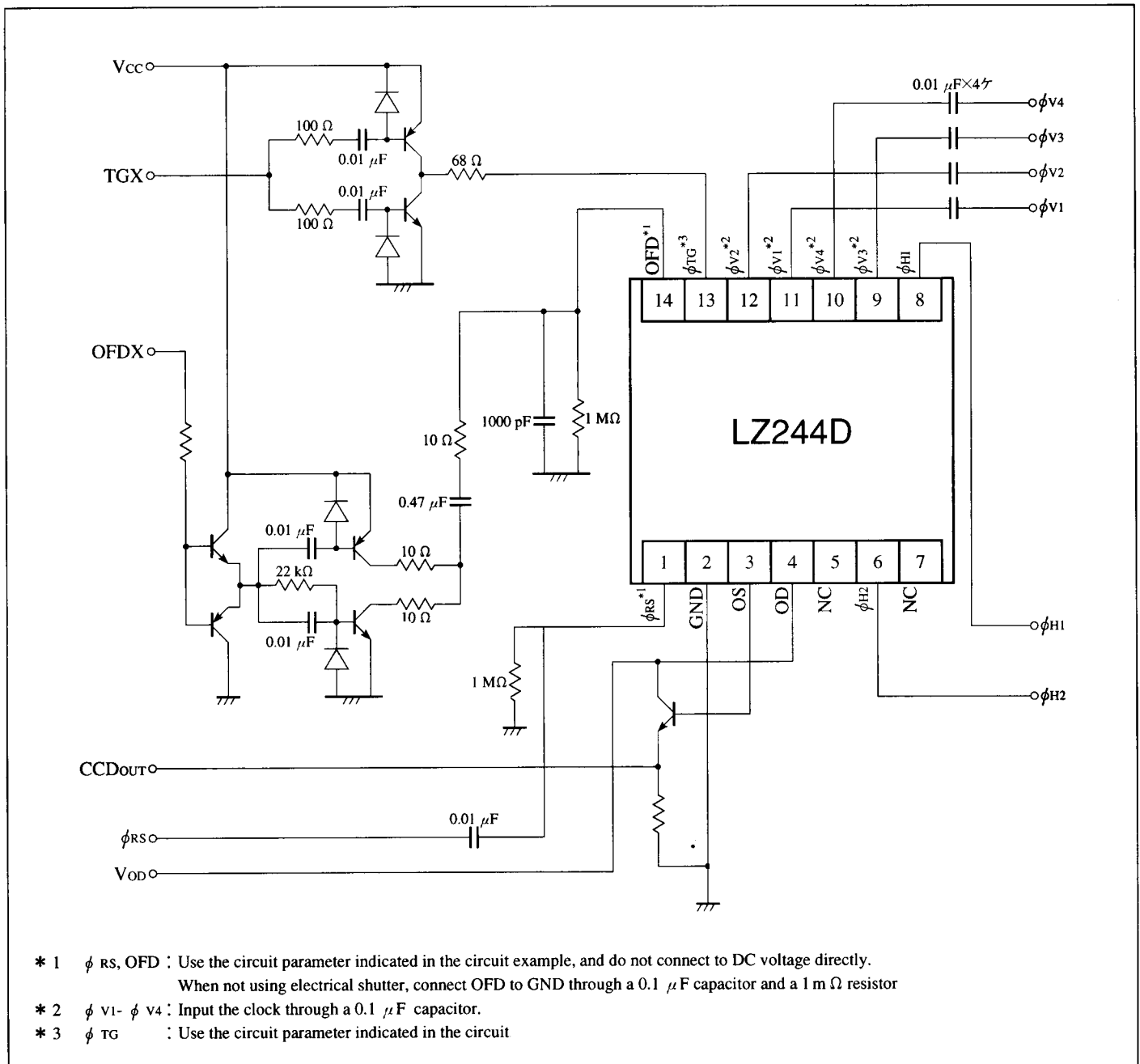

Sharp's Product Line-up (Low-voltage (5 V/12 V) operation 1/4-type CCD Area Sensor)

★Under development

No. of pixels	TV standard		Model No	Electronic shutter (s)	Resolution		Pixels pitch H×V (μ m ²)	Sensitivity TYP. (mV)	Smear ratio TYP. (%)	Package
					Horizontal TV lines	Effective pixel (H×V)				
220 000	Color	PAL	LZ244D*1	1/80 to 1/10 000	230	362×582	9.4×9.4	400	0.005	14WDIP (Plastic)*3
270 000	Color	NTSC	★LZ2415*2	1/60 to 1/10 000	330	512×492	7.2×5.6	310	0.006	14WDIP (Plastic)*3
	B/W	EIA	LZ2416J*2	1/60 to 1/10 000	380	512×492	7.2×5.6	450	0.006	14WDIP (Plastic)*3
320 000	Color	PAL	★LZ2425*2	1/50 to 1/10 000	330	512×582	7.2×4.7	280	0.006	14WDIP (Plastic)*3
	B/W	CCIR	LZ2426J*2	1/50 to 1/10 000	380	512×582	7.2×4.7	400	0.006	14WDIP (Plastic)*3

- *1 OFD voltage no adjust
- *2 With mirror image function
- *3 Pin - pitch 1.27 mm

SHARP

SHARP CORPORATION Japan

HEAD OFFICE

SALES & MARKETING GROUP-ELECTRONIC
COMPONENTS & DEVICES
22-22, NAGAIKE-CHO, ABENO-KU, OSAKA 545, JAPAN
PHONE: (81) 6-621-1221
FAX: 6117-725300, 6117-725301, 6117-725302

IC SALES DEPARTMENT

INTERNATIONAL IC SALES DEPARTMENT II
2613-1 ICHINOMOTO-CHO TENRI-CITY NARA 632, JAPAN
PHONE: (81) 743-65-1321
FAX: (81) 743-65-1532

U.S.A.

SHARP ELECTRONICS CORPORATION

Microelectronics Group

North American Head Office
5700 Northwest Pacific Rim Blvd. #20,
Camas, WA 98607
PHONE: (1)360-834-2500
FAX : (1)360-834-8903

West
1980 Zanker Road, San Jose, CA 95112
PHONE: (1)408-436-4900
FAX : (1)408-436-0924

5901 Bolsa Ave.,
Huntington Beach, CA 92647
PHONE: (1)714-250-0225
FAX : (1)714-250-0438

1025 Royal Lane (PO box 619035),
DFW Airport, TX 75261-9035
PHONE: (1)972-574-5205
FAX : (1)972-574-9870

10222 Scull Creek, Austin, TX 78730
PHONE: (1)512-349-7262
FAX : (1)512-349-7002

9950 Cypresswood, Suite 350,
Houston, TX 77070
PHONE: (1)281-955-9909
FAX : (1)281-955-9910

East
1300 Naperville Road, Romeoville, IL 60446
PHONE: (1)630-226-2400
FAX : (1)630-759-8572

691 N. Squirrel Road, Suite 110,
Auburn Hills, MI 48326
PHONE: (1)810-377-9220
FAX : (1)810-377-9222

200 Wheeler Rd., Burlington, MA 01803
PHONE: (1)617-270-7979
FAX : (1)617-229-9117

Canterbury Hall, 4815 Emperor Blvd.,
Suite 140, Durham, NC 27703
PHONE: (1)919-941-0065
FAX : (1)919-941-0066

EUROPE

SHARP ELECTRONICS (EUROPE) GmbH

Head Office
Microelectronics Division. (MED)
Sonninstrasse 3, 20097, Hamburg, Germany
PHONE: (49)40-23 76 22 86
FAX : (49)40-23 76 22 32

Germany MED Stuttgart Office
Zettachring 8, 70567, Stuttgart, Germany
PHONE: (49)711-90076-3
FAX : (49)711-90076-50

Germany MED Nürnberg Office
Donaustrasse 69, 90451 Nürnberg, Germany
PHONE: (49)911-642 70 51
FAX : (49)911-642 66 69

France MED Paris Office
Immeuble Rosny 2, Avenue du
Général de Gaulle 93110
Rosny Sous Bois Cédex, France
PHONE: (33)1-48 12 19 00
FAX : (33)1-48 55 46 78

Italy MED Milano Office
Centro Direzionale Colleoni
Palazzo Taurus Ingresso 2
20041 Agrate Brianza, Milano, Italy
PHONE: (39)39-68 99 946
FAX : (39)39-68 99 948

U.K. MED London Office
Centennial Court, Easthampstead Road,
Bracknell, Berkshire RG12 1YQ,
United Kingdom
PHONE: (44)1344-86 99 22
FAX : (44)1344-36 09 03

U.K. MED Scotland Office
Unit 48 Grovewood Business Centre,
Strathclyde Business Park,
Bellshill ML43NQ,
Scotland, United Kingdom
PHONE: (44)1698-84 34 42
FAX : (44)1698-84 28 99

Ireland MED Dublin Office
First Floor, Block 1, St. Johns Court,
Santry, Dublin 9, Ireland
PHONE: (353)1-842 87 05
FAX : (353)1-842 84 55

ASIA

SHARP-ROXY (HONG KONG) LTD.

3rd Business Division,
17/F, Admiralty Centre,
Tower 1, 18 Harcourt Road, Hong Kong
PHONE: (852)28229311
FAX : (852)28660779

SHARP ELECTRONICS (SINGAPORE) PTE., LTD.

Electronic Components Division
438A Alexandra Road #05-01/02
Alexandra Technopark
Singapore 119967
PHONE: (65)271-3566
FAX : (65)271-3855

SHARP ELECTRONIC COMPONENTS (TAIWAN) CORPORATION

8F-A, No. 16, Sec. 4, Nanking E. Rd.,
Taipei, Taiwan, Republic of China
PHONE: (886)2-577-7341
FAX : (886)2-577-7326, (886)2-577-7328

SHARP ELECTRONIC COMPONENTS (KOREA) CORPORATION

RM 501 Geosung B/D, 541,
Dohwa-dong, Mapo-ku, Seoul, Korea
PHONE: (82)2-711-5813 to 5818
FAX : (82)2-711-5819

The circuit application examples in this publication are provided to explain representative applications of SHARP devices and are not intended to guarantee any circuit design or license any intellectual property rights. SHARP takes no responsibility for any problems related to any intellectual property right of a third party resulting from the use SHARP devices.

SHARP reserves the right to make changes in the specifications, characteristics, data, materials, structures and other contents described herein at any time without notice in order to improve design or reliability.

Contact SHARP in order to obtain the latest device specification sheets before using any SHARP device. Manufacturing locations are also subject to change without notice.

In the absence of confirmation by device specification sheets, SHARP takes no responsibility for any defects that occur in equipment using any SHARP devices shown in catalogs, data books, etc.

Observe the following points when using any device in this publication. SHARP takes no responsibility for change caused by improper use of the devices, which does not meet the conditions and absolute maximum ratings for use specified in the relevant specification sheet nor meet the following conditions :

■ The devices in this publication are designed for use in general electronic equipment designs such as :

- Personal computers
- Office automation equipment
- Telecommunication equipment (except for trunk lines)
- Test and measurement equipment
- Industrial control
- Audio visual equipment
- Consumer electronics

■ Measures such as fail-safe function and redundant design should be taken to ensure reliability and safety when SHARP devices are used for or in connection with equipment that requires higher reliability such as :

- Main frame computers

- Transportation control and safety equipment (i.e. aircraft, trains, automobiles, etc.)
- Traffic signals
- Gas leakage sensor breakers
- Alarm equipment
- Various safety devices, etc.

■ SHARP devices shall not be used for or in connection with equipment that requires an extremely high level of reliability and safety such as :

- Military and aero space applications
- Telecommunication equipment (trunk lines)
- Nuclear power control equipment
- Medical and other life support equipment (e.g., scuba)

Contact a SHARP representative in advance when intending to use SHARP devices for any "specific" applications other than those recommended by SHARP or when it is unclear which category mentioned above controls the intended use.

If the SHARP devices listed in this publication fall in the scope of strategic products described in the Foreign Exchange and Foreign Trade Control Law of Japan, it is necessary to obtain export permission or approval under the law in order to export such SHARP devices.

This publication is the proprietary product of SHARP and is copyrighted, with all rights reserved. Under the copyright laws, now part of this publication may be reproduced or transmitted in any form or by any means, electronic or mechanical, for any purpose, in whole or in part, without the express written permission of SHARP. Express written permission is also required before any use of this publication may be made by a third party.

Contact and consult with a SHARP representative if there are any questions about the contents of this publication.

LZ244D, CCD, sensor, imaging, area sensor, pattern recognition