

#### -200 Volt, 0.80Ω HEXFET

HEXFET technology is the key to International Rectifier's advanced line of power MOSFET transistors. The efficient geometry achieves very low on-state resistance combined with high transconductance.

HEXFET transistors also feature all of the well-established advantages of MOSFETs, such as voltage control, very fast switching, ease of paralleling and electrical parameter temperature stability. They are well-suited for applications such as switching power supplies, motor controls, inverters, choppers, audio amplifiers, and high energy pulse circuits, and virtually any application where high reliability is required.

#### Product Summary

Part Number	BV <sub>DSS</sub>	R <sub>DS(on)</sub>	I <sub>D</sub>
JANTX2N6851	-200V	0.80Ω	-4.0A
JANTXV2N6851			

#### Features:

- Avalanche Energy Rating
- Dynamic dv/dt Rating
- Simple Drive Requirements
- Ease of Paralleling
- Hermetically Sealed

#### Absolute Maximum Ratings

	Parameter	JANTX2N6851, JANTXV2N6851	Units
I <sub>D</sub> @ V <sub>GS</sub> = -10V, T <sub>C</sub> = 25°C	Continuous Drain Current	-4.0	A
I <sub>D</sub> @ V <sub>GS</sub> = -10V, T <sub>C</sub> = 100°C	Continuous Drain Current	-2.4	
I <sub>DM</sub>	Pulsed Drain Current ①	-16	
P <sub>D</sub> @ T <sub>C</sub> = 25°C	Max. Power Dissipation	25	W
	Linear Derating Factor	0.20	W/K ⑤
V <sub>GS</sub>	Gate-to-Source Voltage	±20	V
dv/dt	Peak Diode Recovery dv/dt ③	-5.0	V/ns
T <sub>J</sub>	Operating Junction	-55 to 150	°C
T <sub>STG</sub>	Storage Temperature Range		
	Lead Temperature	300 (0.063 in. (1.6mm) from case for 10.5 seconds)	
	Weight	0.98 (typical)	

# JANTX2N6851, JANTXV2N6851 Device

## Electrical Characteristics @ T<sub>j</sub> = 25°C (Unless Otherwise Specified)

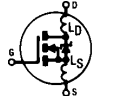
	Parameter	Min.	Typ.	Max.	Units	Test Conditions
BV <sub>DSS</sub>	Drain-to-Source Breakdown Voltage	-200	—	—	V	V <sub>GS</sub> = 0V, I <sub>D</sub> = -1.0 mA
ΔBV <sub>DSS</sub> /ΔT <sub>J</sub>	Temperature Coefficient of Breakdown Voltage	—	-0.22	—	V/°C	Reference to 25°C, I <sub>D</sub> = -1.0 mA
RDS(on)	Static Drain-to-Source	—	—	0.80	Ω	V <sub>GS</sub> = -10V, I <sub>D</sub> = -2.4A <sup>④</sup>
	On-State Resistance	—	—	1.68		
VGS(th)	Gate Threshold Voltage	-2.0	—	-4.0	V	V <sub>DS</sub> = V <sub>GS</sub> , I <sub>D</sub> = -250μA
g <sub>fs</sub>	Forward Transconductance	2.2	—	—	S (r <sub>o</sub> )	V <sub>DS</sub> > -15V, I <sub>DS</sub> = -2.4A <sup>④</sup>
IDSS	Zero Gate Voltage Drain Current	—	—	-25	μA	V <sub>DS</sub> = 0.8 x Max Rating, V <sub>GS</sub> = 0V
		—	—	-250		
IGSS	Gate-to-Source Leakage Forward	—	—	-100	nA	V <sub>GS</sub> = -20V
IGSS	Gate-to-Source Leakage Reverse	—	—	100	nA	V <sub>GS</sub> = 20V
Q <sub>g</sub>	Total Gate Charge	14.7	—	34.8	nC	V <sub>GS</sub> = -10V, I <sub>D</sub> = -4.0A V <sub>DS</sub> = Max. Rating x 0.5 see figures 6 and 13
Q <sub>gs</sub>	Gate-to-Source Charge	0.8	—	7.0		
Q <sub>gd</sub>	Gate-to-Drain ("Miller") Charge	5.0	—	17		
t <sub>d(on)</sub>	Turn-On Delay Time	—	—	50	ns	V <sub>DD</sub> = -100V, I <sub>D</sub> = -4.0A, R <sub>G</sub> = 7.5Ω, V <sub>GS</sub> = -10V  see figure 10
t <sub>r</sub>	Rise Time	—	—	100		
t <sub>d(off)</sub>	Turn-Off Delay Time	—	—	100		
t <sub>f</sub>	Fall Time	—	—	80		
LD	Internal Drain Inductance	—	5.0	—	nH	<p>Measured from the drain lead, 6mm (0.25 in.) from package to center of die.</p> <p>Modified MOSFET symbol showing the internal inductances.</p> 
LS	Internal Source Inductance	—	15.0	—		
C <sub>iss</sub>	Input Capacitance	—	700	—	pF	V <sub>GS</sub> = 0V, V <sub>DS</sub> = -25V f = 1.0 MHz see figure 5
C <sub>oss</sub>	Output Capacitance	—	200	—		
C <sub>rss</sub>	Reverse Transfer Capacitance	—	40	—		

## Source-Drain Diode Ratings and Characteristics

	Parameter	Min.	Typ.	Max.	Units	Test Conditions
I <sub>S</sub>	Continuous Source Current (Body Diode)	—	—	-4.0	A	Modified MOSFET symbol showing the integral reverse p-n junction rectifier.
I <sub>SM</sub>	Pulse Source Current (Body Diode) <sup>①</sup>	—	—	-16		
V <sub>SD</sub>	Diode Forward Voltage	—	—	-6.0	V	T <sub>j</sub> = 25°C, I <sub>S</sub> = -4.0A, V <sub>GS</sub> = 0V <sup>④</sup>
t <sub>rr</sub>	Reverse Recovery Time	—	—	400	ns	T <sub>j</sub> = 25°C, I <sub>F</sub> = -4.0A, di/dt ≤ -100A/μs V <sub>DD</sub> ≤ -50V <sup>④</sup>
Q <sub>RR</sub>	Reverse Recovery Charge	—	—	4.0	μC	
t <sub>on</sub>	Forward Turn-On Time	Intrinsic turn-on time is negligible. Turn-on speed is substantially controlled by L <sub>S</sub> + L <sub>D</sub> .				

## Thermal Resistance

	Parameter	Min.	Typ.	Max.	Units	Test Conditions
R <sub>thJC</sub>	Junction-to-Case	—	—	5.0	K/W	Typical socket mount
R <sub>thJA</sub>	Junction-to-Ambient	—	—	175		

# JANTX2N6851, JANTXV2N6851 Device

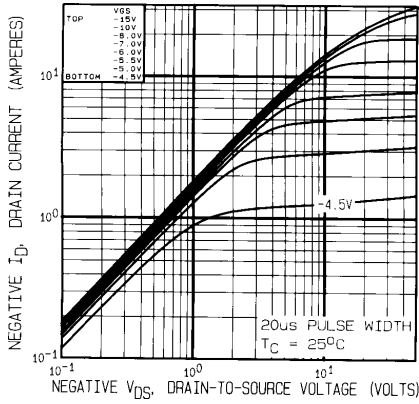

**Fig. 1 — Typical Output Characteristics**  
 $T_c = 25^\circ\text{C}$

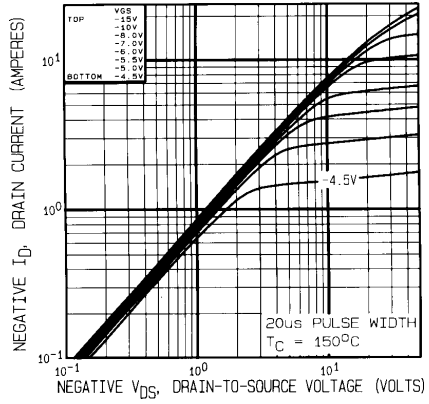

**Fig. 2 — Typical Output Characteristics**  
 $T_c = 150^\circ\text{C}$

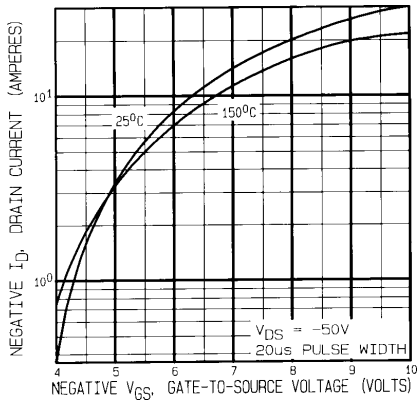

**Fig. 3 — Typical Transfer Characteristics**

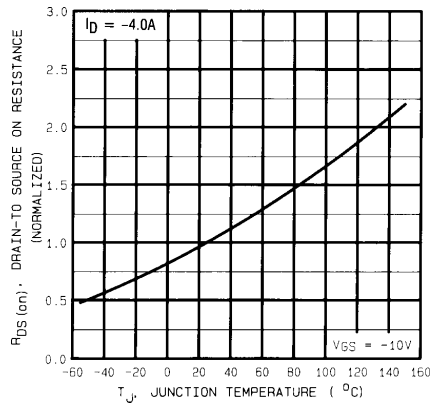

**Fig. 4 — Normalized On-Resistance Vs. Temperature**

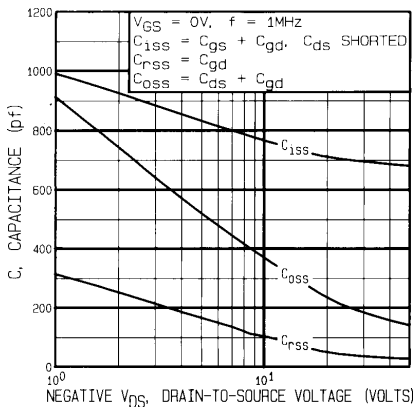

**Fig. 5 — Typical Capacitance Vs. Drain-to-Source Voltage**

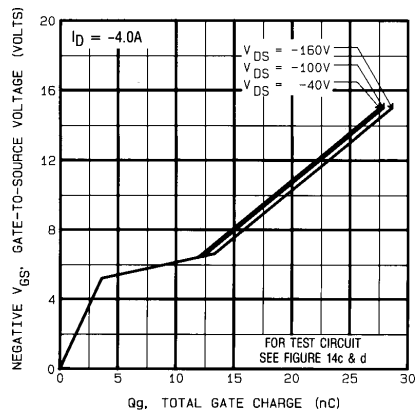

**Fig. 6 — Typical Gate Charge Vs. Gate-to-Source Voltage**

# JANTX2N6851, JANTXV2N6851 Device

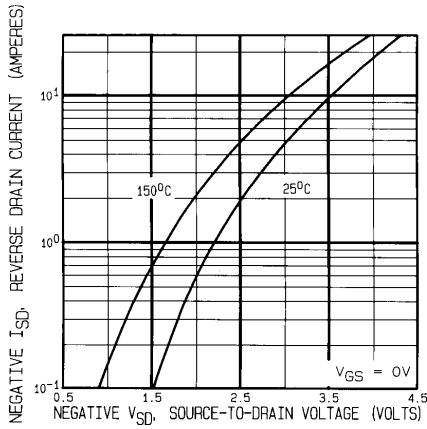

Fig. 7 — Typical Source-to-Drain Diode Forward Voltage

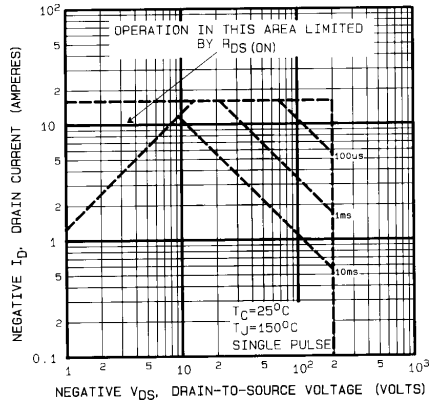

Fig. 8 — Maximum Safe Operating Area

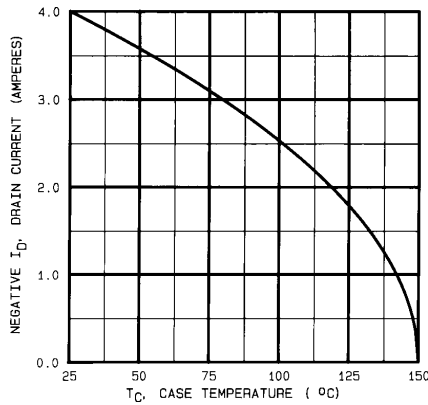

Fig. 9 — Maximum Drain Current Vs. Case Temperature

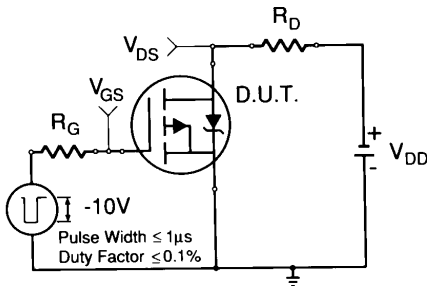

Fig. 10a — Switching Time Test Circuit

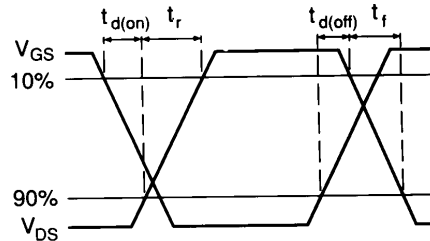

Fig. 10b — Switching Time Waveforms

# JANTX2N6851, JANTXV2N6851 Device

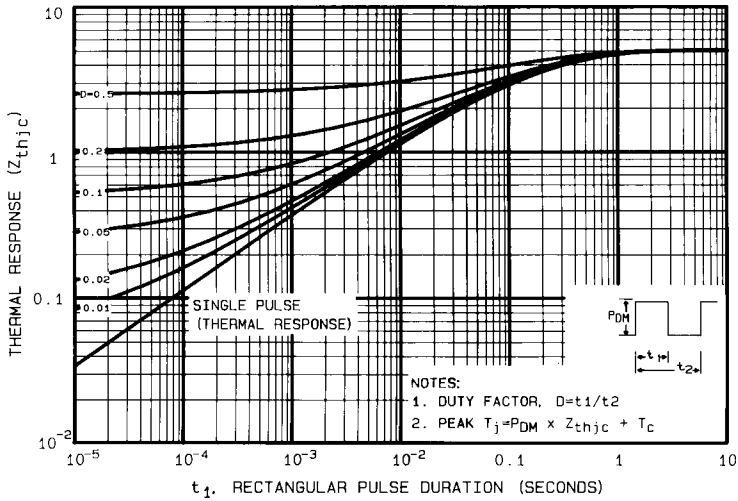

Fig. 11 — Maximum Effective Transient Thermal Impedance, Junction-to-Case Vs. Pulse Duration

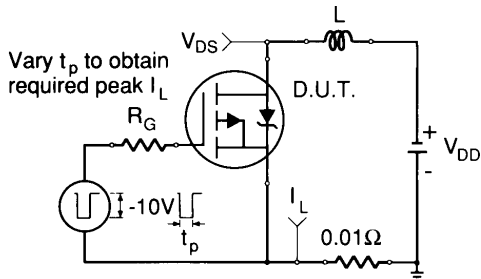

Fig. 12a — Unclamped Inductive Test Circuit

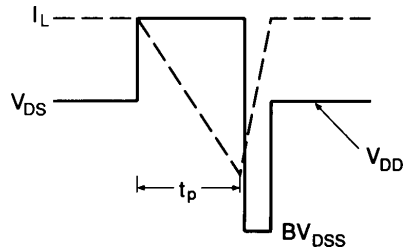

Fig. 12b — Unclamped Inductive Waveforms

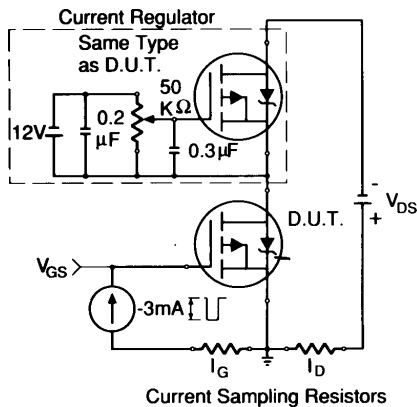

Fig. 13a — Gate Charge Test Circuit

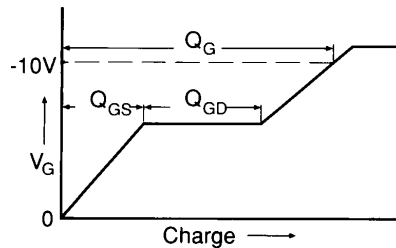
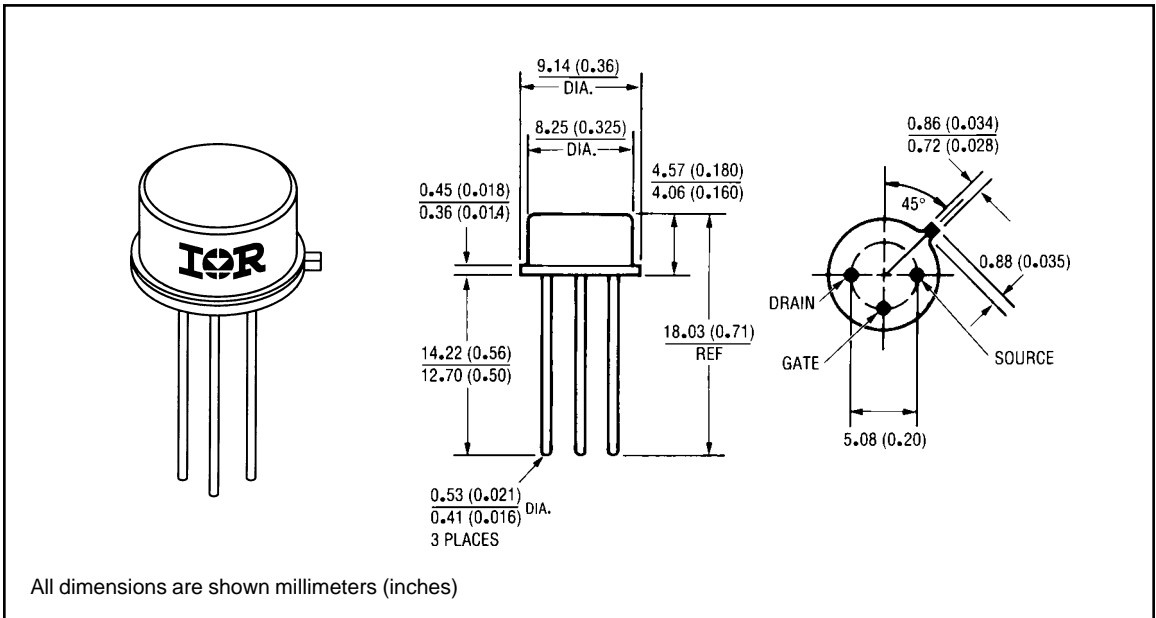

Fig. 13b — Basic Gate Charge Waveform

# JANTX2N6851, JANTXV2N6851 Device

- ① Repetitive Rating; Pulse width limited by maximum junction temperature. (see figure 11)
- ② @  $V_{DD} = -50V$ , Starting  $T_J = 25^\circ C$ ,  
 $E_{AS} = [0.5 * L * (I_L^2) * [BV_{DSS}/(BV_{DSS}-V_{DD})]]$   
 Peak  $I_L = -4.0A$ ,  $V_{GS} = -10V$ ,  $25 \leq R_G \leq 200\Omega$
- ③  $I_{SD} \leq -4.0A$ ,  $di/dt \leq -120A/\mu s$ ,  
 $V_{DD} \leq BV_{DSS}$ ,  $T_J \leq 150^\circ C$
- ④ Pulse width  $\leq 300 \mu s$ ; Duty Cycle  $\leq 2\%$
- ⑤  $K/W = ^\circ C/W$   
 $W/K = W/^\circ C$

## Case Outline and Dimensions — TO-205AF (TO-39)



International  
**IR** Rectifier

**WORLD HEADQUARTERS:** 233 Kansas St., El Segundo, California 90245, Tel: (310) 322 3331  
**EUROPEAN HEADQUARTERS:** Hurst Green, Oxted, Surrey RH8 9BB, UK Tel: ++ 44 1883 732020  
**IR CANADA:** 7321 Victoria Park Ave., Suite 201, Markham, Ontario L3R 2Z8, Tel: (905) 475 1897  
**IR GERMANY:** Saalburgstrasse 157, 61350 Bad Homburg Tel: ++ 49 6172 96590  
**IR ITALY:** Via Liguria 49, 10071 Borgaro, Torino Tel: ++ 39 11 451 0111  
**IR FAR EAST:** K&H Bldg., 2F, 3-30-4 Nishi-Ikeburo 3-Chome, Toshima-Ki, Tokyo Japan 171 Tel: 81 3 3983 0086  
**IR SOUTHEAST ASIA:** 315 Outram Road, #10-02 Tan Boon Liat Building, Singapore 0316 Tel: 65 221 8371  
<http://www.irf.com/> Data and specifications subject to change without notice. 10/96