

PDP TRENCH IGBT

Features

- Advanced Trench IGBT Technology
- Optimized for Sustain and Energy Recovery Circuits in PDP Applications
- Low $V_{CE(on)}$ and Energy per Pulse (E_{PULSE}^{TM}) for Improved Panel Efficiency
- High Repetitive Peak Current Capability
- Lead Free Package

Key Parameters		
$V_{CE\ min}$	330	V
$V_{CE(on)}\ typ.\ @\ I_C = 70A$	1.69	V
$I_{RP\ max}\ @\ T_C = 25^\circ C\ ①$	250	A
$T_J\ max$	150	$^\circ C$

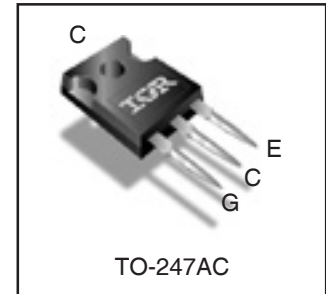
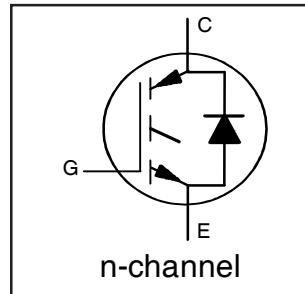

G	C	E
Gate	Collector	Emitter

Description

This IGBT is specifically designed for applications in Plasma Display Panels. This device utilizes advanced trench IGBT technology to achieve low $V_{CE(on)}$ and low E_{PULSE}^{TM} rating per silicon area which improve panel efficiency. Additional features are $150^\circ C$ operating junction temperature and high repetitive peak current capability. These features combine to make this IGBT a highly efficient, robust and reliable device for PDP applications.

Absolute Maximum Ratings

	Parameter	Max.	Units
V_{GE}	Gate-to-Emitter Voltage	± 30	V
$I_C @ T_C = 25^\circ C$	Continuous Collector Current, $V_{GE} @ 15V$	70	A
$I_C @ T_C = 100^\circ C$	Continuous Collector, $V_{GE} @ 15V$	40	
$I_{RP} @ T_C = 25^\circ C$	Repetitive Peak Current ①	250	
$P_D @ T_C = 25^\circ C$	Power Dissipation	160	W
$P_D @ T_C = 100^\circ C$	Power Dissipation	63	
	Linear Derating Factor	1.3	$W/^\circ C$
T_J	Operating Junction and	-40 to + 150	$^\circ C$
T_{STG}	Storage Temperature Range		
	Soldering Temperature for 10 seconds	300	
	Mounting Torque, 6-32 or M3 Screw	10lb·in (1.1N·m)	N

Thermal Resistance

	Parameter	Typ.	Max.	Units
$R_{\theta JC}$ (IGBT)	Thermal Resistance Junction-to-Case-(each IGBT) ②	—	0.80	$^\circ C/W$
$R_{\theta JC}$ (Diode)	Thermal Resistance Junction-to-Case-(each Diode) ②	1.6	2.4	
$R_{\theta CS}$	Case-to-Sink (flat, greased surface)	0.24	—	
$R_{\theta JA}$	Junction-to-Ambient (typical socket mount) ②	—	40	
	Weight	6.0 (0.21)	—	g (oz)

Electrical Characteristics @ $T_J = 25^\circ\text{C}$ (unless otherwise specified)

	Parameter	Min.	Typ.	Max.	Units	Conditions		
BV_{CES}	Collector-to-Emitter Breakdown Voltage	330	—	—	V	$V_{GE} = 0V, I_{CE} = 1\text{ mA}$		
$\Delta BV_{CES}/\Delta T_J$	Breakdown Voltage Temp. Coefficient	—	0.34	—	V/ $^\circ\text{C}$	Reference to 25°C , $I_{CE} = 1\text{ mA}$		
$V_{CE(on)}$	Static Collector-to-Emitter Voltage	—	1.18	1.48	V	$V_{GE} = 15V, I_{CE} = 25A$ ③		
		—	1.36	1.68		$V_{GE} = 15V, I_{CE} = 40A$ ③		
		—	1.69	2.09		$V_{GE} = 15V, I_{CE} = 70A$ ③		
		—	2.26	2.76		$V_{GE} = 15V, I_{CE} = 120A$ ③		
		—	1.93	—		$V_{GE} = 15V, I_{CE} = 70A, T_J = 150^\circ\text{C}$		
$V_{GE(th)}$	Gate Threshold Voltage	2.6	—	5.0	V	$V_{CE} = V_{GE}, I_{CE} = 500\mu\text{A}$		
$\Delta V_{GE(th)}/\Delta T_J$	Gate Threshold Voltage Coefficient	—	-11	—	mV/ $^\circ\text{C}$			
I_{CES}	Collector-to-Emitter Leakage Current	—	2.0	25	μA	$V_{CE} = 330V, V_{GE} = 0V$		
		—	5.0	—		$V_{CE} = 330V, V_{GE} = 0V, T_J = 100^\circ\text{C}$		
		—	100	—		$V_{CE} = 330V, V_{GE} = 0V, T_J = 150^\circ\text{C}$		
I_{GES}	Gate-to-Emitter Forward Leakage	—	—	100	nA	$V_{GE} = 30V$		
	Gate-to-Emitter Reverse Leakage	—	—	-100		$V_{GE} = -30V$		
g_{fe}	Forward Transconductance	—	50	—	S	$V_{CE} = 25V, I_{CE} = 25A$		
Q_g	Total Gate Charge	—	85	—	nC	$V_{CE} = 200V, I_C = 25A, V_{GE} = 15V$ ③		
Q_{gc}	Gate-to-Collector Charge	—	31	—				
$t_{d(on)}$	Turn-On delay time	—	47	—	ns	$I_C = 25A, V_{CC} = 196V$ $R_G = 10\Omega, L = 200\mu\text{H}, L_S = 200\text{nH}$ $T_J = 25^\circ\text{C}$		
t_r	Rise time	—	37	—				
$t_{d(off)}$	Turn-Off delay time	—	176	—				
t_f	Fall time	—	99	—				
$t_{d(on)}$	Turn-On delay time	—	45	—				
$t_{d(on)}$	Turn-On delay time	—	38	—	ns	$I_C = 25A, V_{CC} = 196V$ $R_G = 10\Omega, L = 200\mu\text{H}, L_S = 200\text{nH}$ $T_J = 150^\circ\text{C}$		
		t_r	Rise time	—			38	—
		$t_{d(off)}$	Turn-Off delay time	—			228	—
		t_f	Fall time	—			183	—
t_{st}	Shoot Through Blocking Time	100	—	—	ns	$V_{CC} = 240V, V_{GE} = 15V, R_G = 5.1\Omega$ $L = 220\text{nH}, C = 0.40\mu\text{F}, V_{GE} = 15V$ $V_{CC} = 240V, R_G = 5.1\Omega, T_J = 25^\circ\text{C}$		
E_{PULSE}	Energy per Pulse	—	834	—	μJ	$L = 220\text{nH}, C = 0.40\mu\text{F}, V_{GE} = 15V$ $V_{CC} = 240V, R_G = 5.1\Omega, T_J = 25^\circ\text{C}$		
		—	985	—		$L = 220\text{nH}, C = 0.40\mu\text{F}, V_{GE} = 15V$ $V_{CC} = 240V, R_G = 5.1\Omega, T_J = 100^\circ\text{C}$		
C_{iss}	Input Capacitance	—	2297	—	pF	$V_{GE} = 0V$ $V_{CE} = 30V$ $f = 1.0\text{MHz}$, See Fig.13		
C_{oss}	Output Capacitance	—	141	—				
C_{riss}	Reverse Transfer Capacitance	—	74	—				
L_C	Internal Collector Inductance	—	5.0	—	nH	Between lead, 6mm (0.25in.) from package and center of die contact		
L_E	Internal Emitter Inductance	—	13	—				

Diode Characteristics @ $T_J = 25^\circ\text{C}$ (unless otherwise specified)

	Parameter	Min.	Typ.	Max.	Units	Conditions	
$I_{F(AV)}$	Average Forward Current at $T_C = 155^\circ\text{C}$	—	—	8.0	A		
I_{FSM}	Non Repetitive Peak Surge Current	—	—	100	A	$T_J = 155^\circ\text{C}, PW = 6.0\text{ms}$ half sine wave	
V_F	Forward Voltage	—	1.19	1.3	V	$I_F = 8A$	
		—	0.94	1.0		$I_F = 8A, T_J = 150^\circ\text{C}$	
t_{rr}	Reverse Recovery Time	—	35	60	ns	$I_F = 1A, di/dt = -50A/\mu\text{s}, V_R = 30V$ $T_J = 25^\circ\text{C}$	
		—	43	—			$T_J = 125^\circ\text{C}$
		—	67	—			$T_J = 125^\circ\text{C}$
Q_{rr}	Reverse Recovery Charge	—	60	—	nC	$T_J = 25^\circ\text{C}$ $T_J = 125^\circ\text{C}$ $I_F = 8A$ $di/dt = 200A/\mu\text{s}$ $V_R = 200V$	
		—	210	—			
I_{rr}	Peak Recovery Current	—	2.8	—	A	$T_J = 25^\circ\text{C}$ $T_J = 125^\circ\text{C}$	
		—	6.3	—			

Notes:

- ① Half sine wave with duty cycle = 0.1, $t_{on} = 2\mu\text{sec}$.
② R_θ is measured at T_J of approximately 90°C .

- ③ Pulse width $\leq 400\mu\text{s}$; duty cycle $\leq 2\%$.

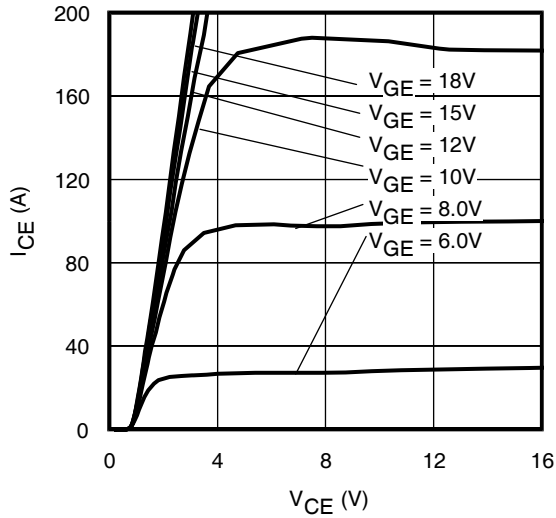

Fig 1. Typical Output Characteristics @ 25°C

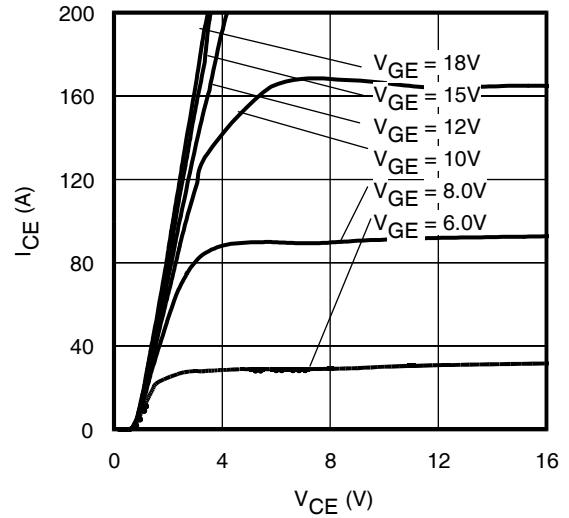

Fig 2. Typical Output Characteristics @ 75°C

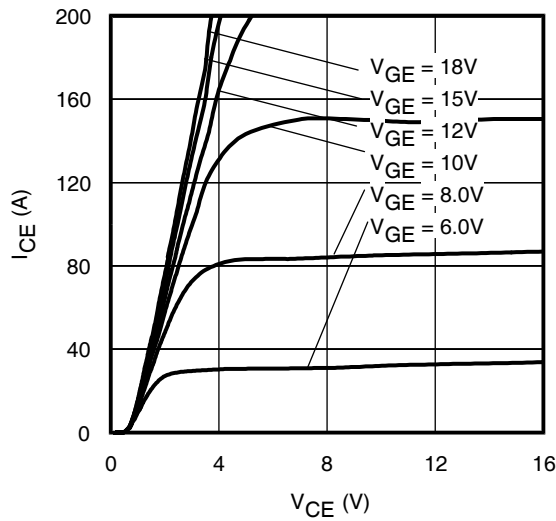

Fig 3. Typical Output Characteristics @ 125°C

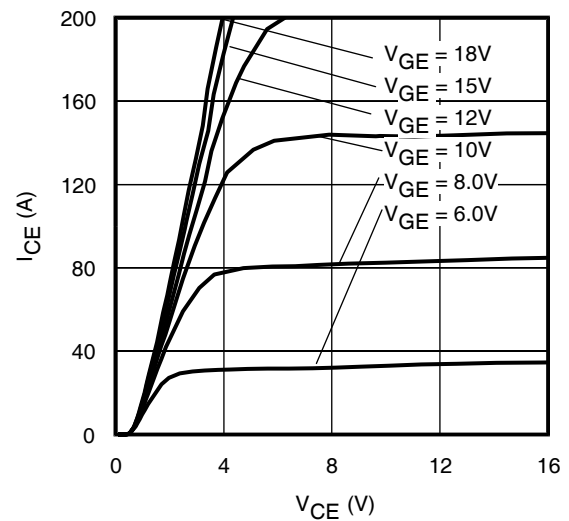

Fig 4. Typical Output Characteristics @ 150°C

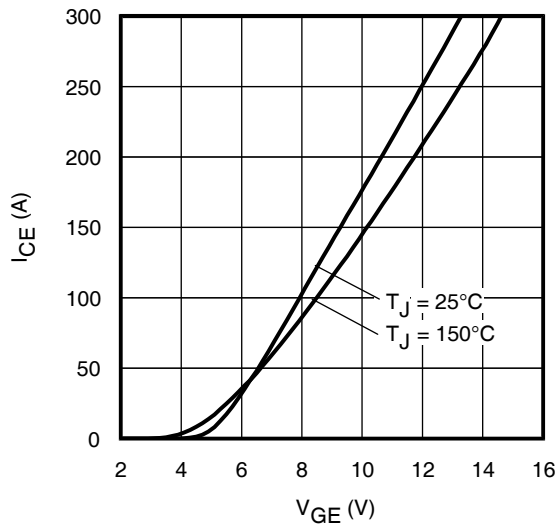

Fig 5. Typical Transfer Characteristics

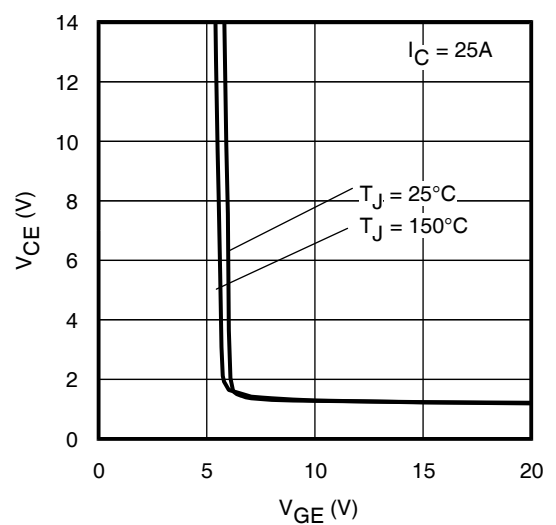

Fig 6. $V_{CE(ON)}$ vs. Gate Voltage

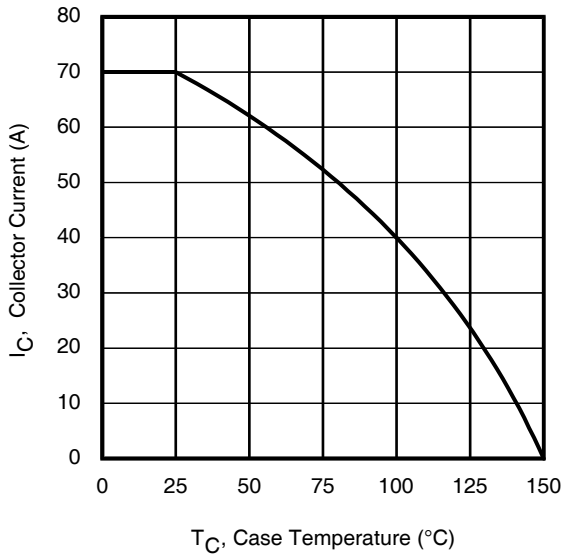

Fig 7. Maximum Collector Current vs. Case Temperature

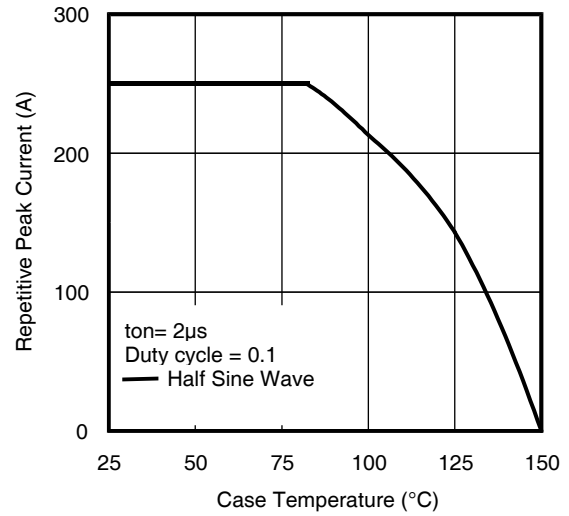

Fig 8. Typical Repetitive Peak Current vs. Case Temperature

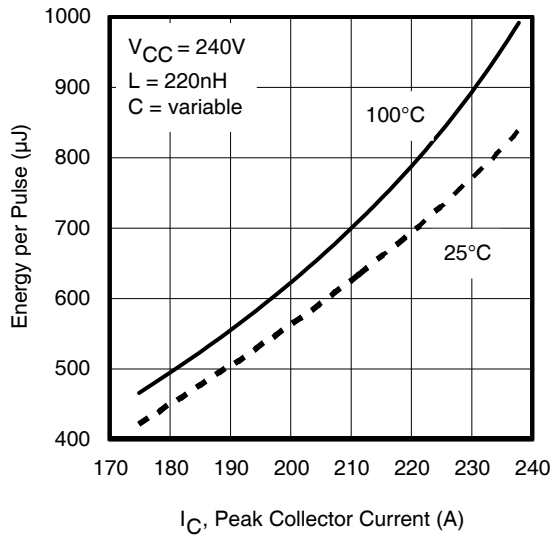

Fig 9. Typical E_{PULSE} vs. Collector Current

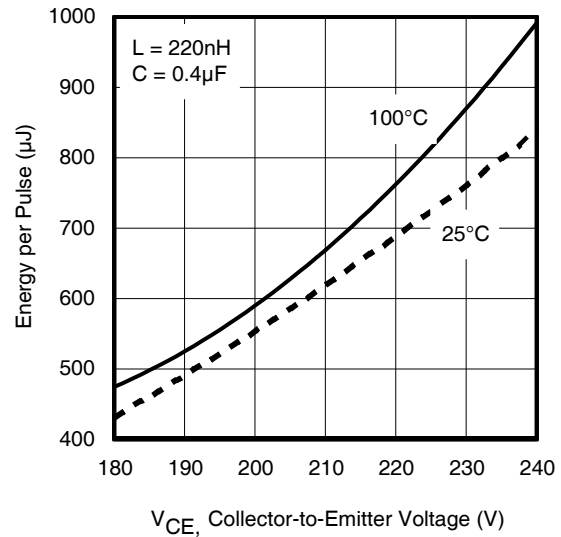

Fig 10. Typical E_{PULSE} vs. Collector-to-Emitter Voltage

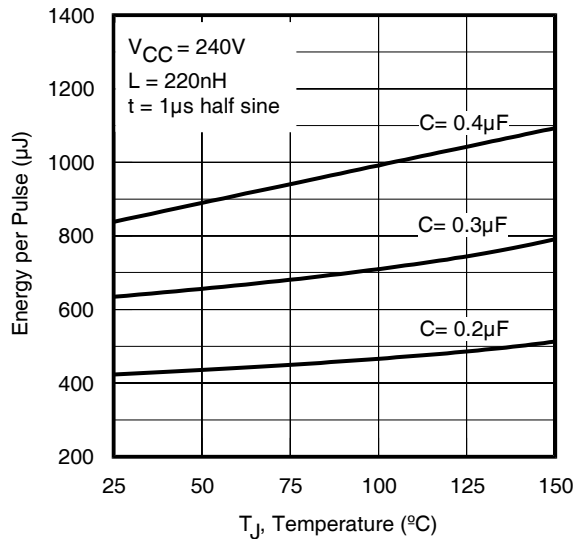

Fig 11. E_{PULSE} vs. Temperature

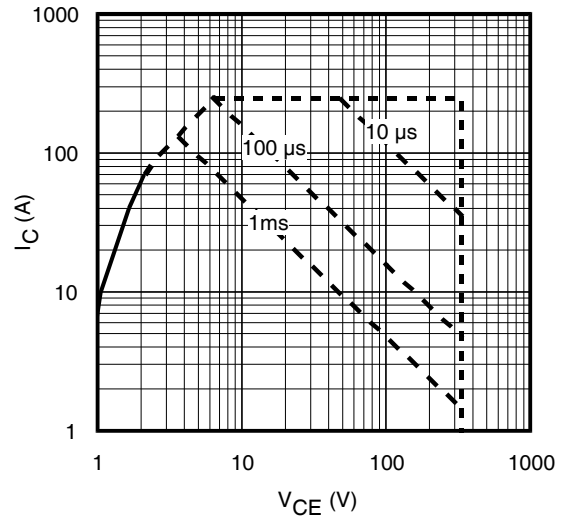

Fig 12. Forward Bias Safe Operating Area

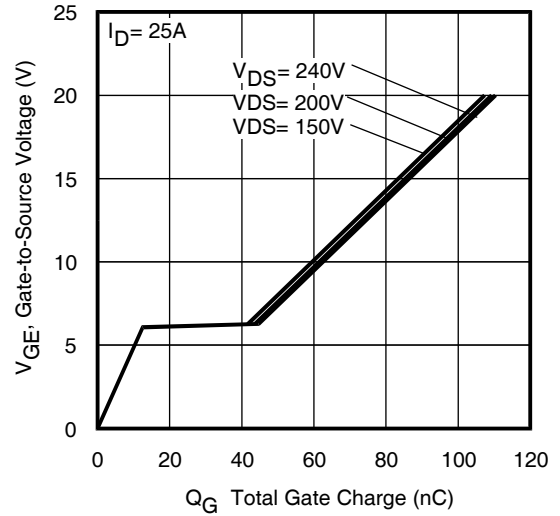
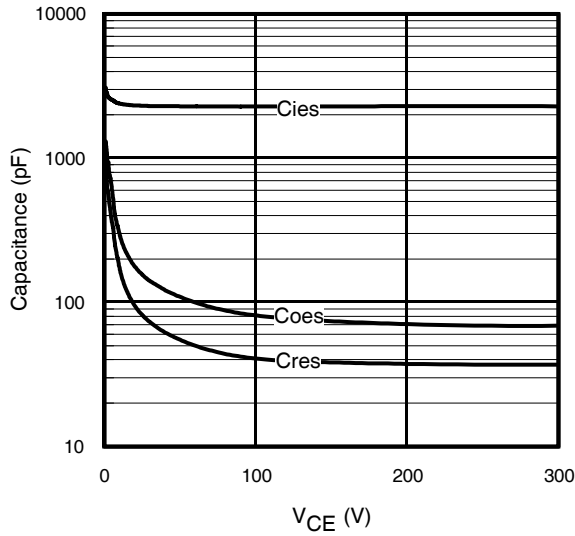

Fig 13. Typical Capacitance vs. Collector-to-Emitter Voltage

Fig 14. Typical Gate Charge vs. Gate-to-Emitter Voltage

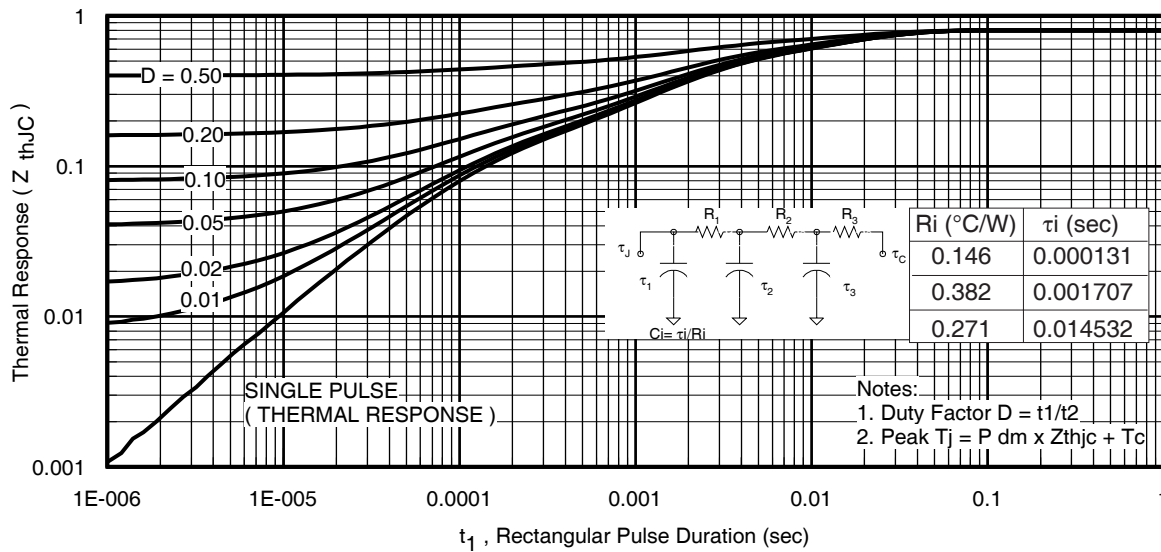

Fig 15. Maximum Effective Transient Thermal Impedance, Junction-to-Case (IGBT)

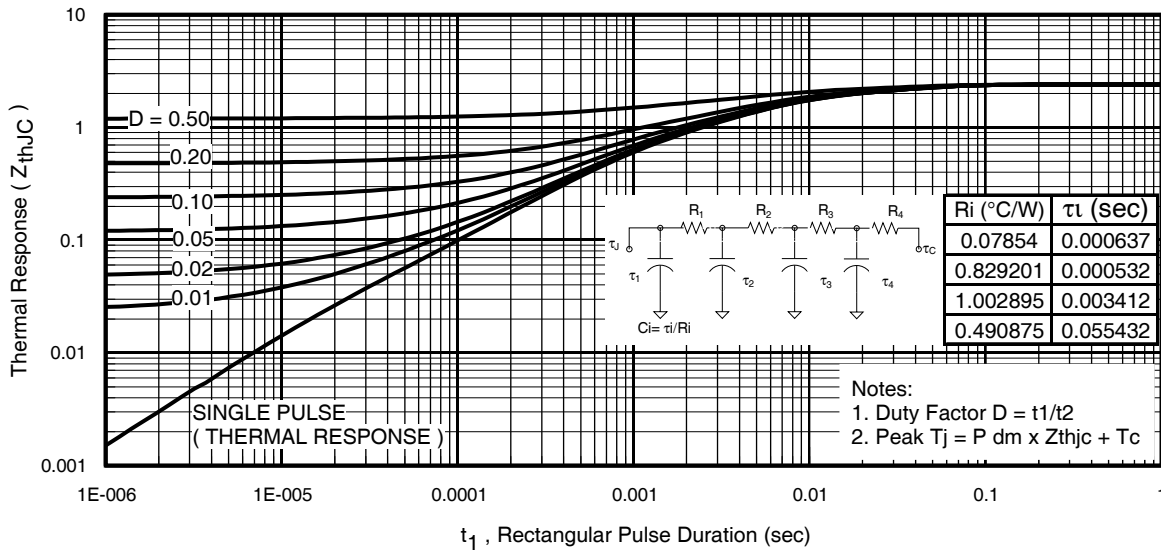

Fig 16. Maximum Effective Transient Thermal Impedance, Junction-to-Case (DIODE)

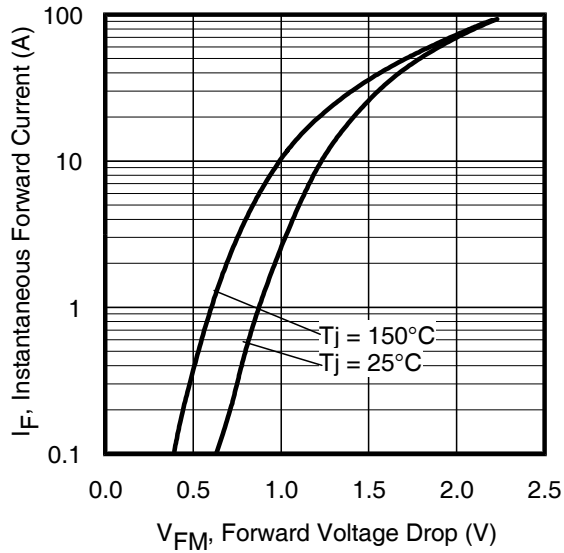

Fig. 17 - Typical Forward Voltage Drop Characteristics

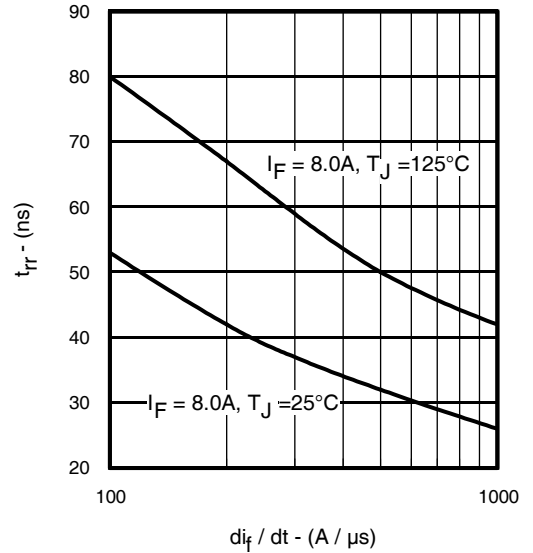

Fig. 18 - Typical Reverse Recovery vs. di_F/dt

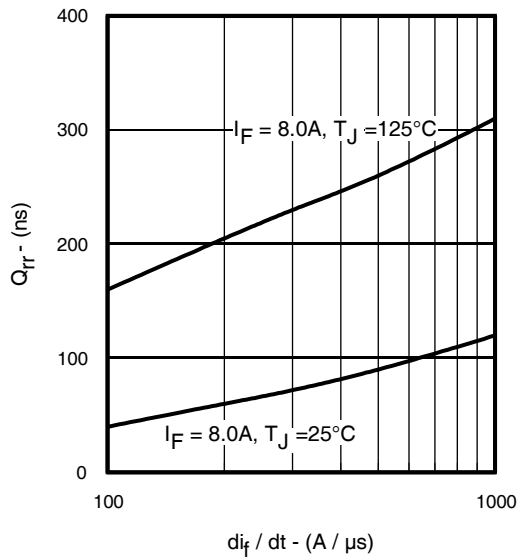

Fig. 19 - Typical Stored Charge vs. di_F/dt

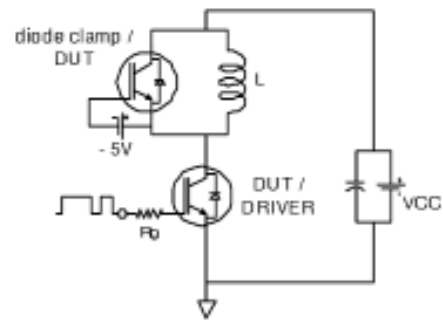

Fig. 20 - Switching Loss Circuit

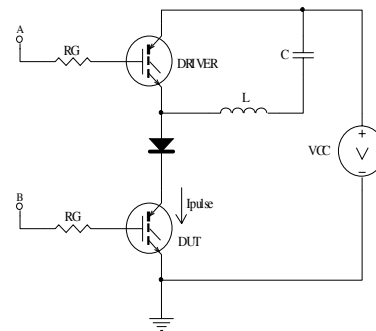

Fig 21a. t_{st} and E_{PULSE} Test Circuit

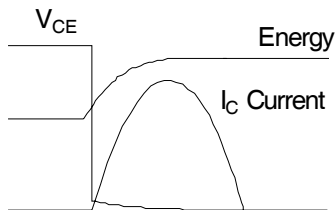

Fig 21b. t_{st} Test Waveforms

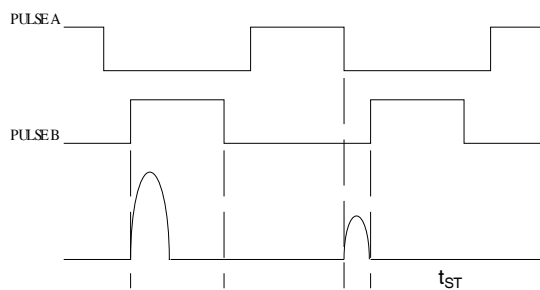

Fig 21c. E_{PULSE} Test Waveforms

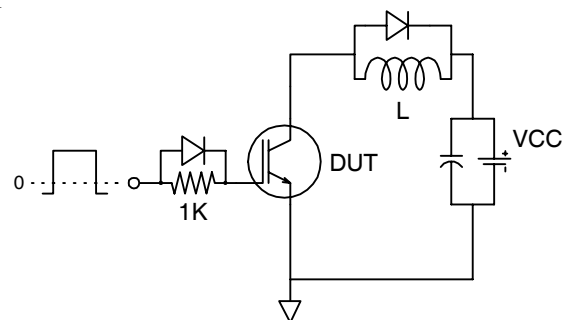
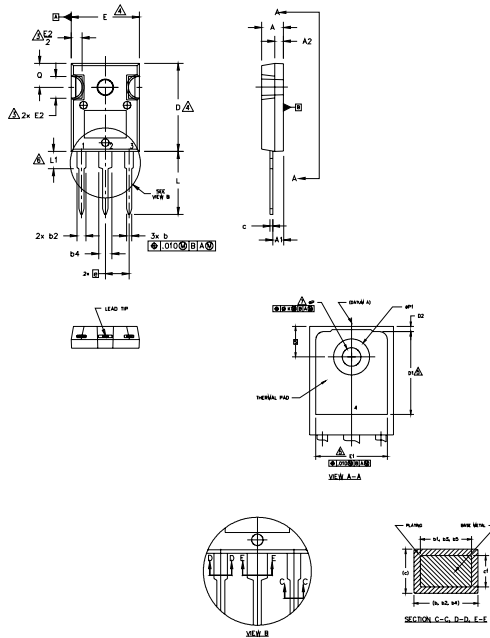

Fig. 22 - Gate Charge Circuit (turn-off)

TO-247AC Package Outline Dimensions are shown in millimeters (inches)



- NOTES:
1. DIMENSIONING AND TOLERANCING AS PER ASME Y14.5M 1994.
 2. DIMENSIONS ARE SHOWN IN INCHES.
 3. CONTOUR OF SLOT OPTIONAL.
 4. DIMENSION D & E DO NOT INCLUDE MOLD FLASH. MOLD FLASH SHALL NOT EXCEED .005" (0.127) PER SIDE. THESE DIMENSIONS ARE MEASURED AT THE OUTERMOST EXTREMES OF THE PLASTIC BODY.
 5. THERMAL PAD CONTOUR OPTIONAL WITHIN DIMENSIONS D1 & E1.
 6. LEAD FINISH UNCONTROLLED IN L1.
 7. ϕP TO HAVE A MAXIMUM DRAFT ANGLE OF 1.5 ° TO THE TOP OF THE PART WITH A MAXIMUM HOLE DIAMETER OF .154 INCH.
 8. OUTLINE CONFORMS TO JEDEC OUTLINE TO-247AC .

SYMBOL	DIMENSIONS				NOTES
	INCHES		MILLIMETERS		
	MIN.	MAX.	MIN.	MAX.	
A	.185	.209	4.65	5.31	
A1	.087	.102	2.21	2.59	
A2	.099	.098	1.50	2.49	
b	.039	.055	0.99	1.40	
b1	.039	.055	0.99	1.35	
b2	.065	.094	1.65	2.39	
b3	.065	.092	1.65	2.34	
b4	.102	.135	2.59	3.43	
b5	.102	.133	2.59	3.38	
c	.015	.035	0.38	0.89	
c1	.015	.033	0.38	0.84	
D	.776	.815	19.71	20.70	
D1	.515	-	13.08	-	4
D2	.020	.053	0.51	1.35	5
E	.602	.625	15.29	15.87	4
E1	.530	-	13.46	-	
E2	.178	.216	4.52	5.49	
e	.215 BSC		5.46 BSC		
ϕH	.010		0.25		
L	.569	.634	14.20	16.10	
L1	.146	.169	3.71	4.29	
ϕP	.140	.144	3.56	3.66	
$\phi P1$	-	.291	-	7.39	
Q	.209	.224	5.31	5.69	
S	.217 BSC		5.51 BSC		

LEAD ASSIGNMENTS

- HEXFET**
- 1.- GATE
 - 2.- DRAIN
 - 3.- SOURCE
 - 4.- DRAIN

IGBTs CoPACK

- 1.- GATE
- 2.- COLLECTOR
- 3.- EMITTER
- 4.- COLLECTOR

DIODES

- 1.- ANODE/OPEN
- 2.- CATHODE
- 3.- ANODE

TO-247AC Part Marking Information

EXAMPLE: THIS IS AN IRFPE30
WITH ASSEMBLY
LOT CODE 5657
ASSEMBLED ON WW 35, 2001
IN THE ASSEMBLY LINE "H"

Note: "P" in assembly line position
indicates "Lead-Free"

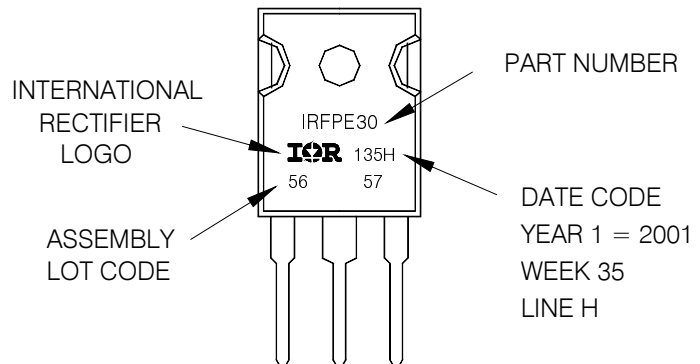

TO-247AC package is not recommended for Surface Mount Application.

Note: For the most current drawing please refer to IR website at <http://www.irf.com/package/pkight.html>

The specifications set forth in this data sheet are the sole and exclusive specifications applicable to the identified product, and no specifications or features are implied whether by industry custom, sampling or otherwise. We qualify our products in accordance with our internal practices and procedures, which by their nature do not include qualification to all possible or even all widely used applications. Without limitation, we have not qualified our product for medical use or applications involving hi-reliability applications. Customers are encouraged to and responsible for qualifying product to their own use and their own application environments, especially where particular features are critical to operational performance or safety. Please contact your IR representative if you have specific design or use requirements or for further information.

Data and specifications subject to change without notice. This product has been designed for the Industrial market. Qualification Standards can be found on IR's Web site.