

February 2000

NOT RECOMMENDED FOR NEW DESIGNS
NO RECOMMENDED REPLACEMENT
 Call Central Applications 1-888-INTERSIL
 or email: centapp@intersil.com

Features

- Over Operating Temperature Range . . . -40°C to 125°C
 - Max V_{SAT} at 1A 1V
 - Current Switching Capability 1A
 - Power Supply Range 4.5V to 25V
- Over-Voltage Shutdown Protected
- Over-Current Limiting
- Thermal Limiting Protection
- Negative Output Voltage Clamp
- CMOS/TTL Logic Level Control Input
- Load Dump 60V_{PEAK}
- Reverse Battery Protection to -16V

Applications

- Motor Driver/Controller
- Driver for Solenoids, Relays and Lamps
- MOSFET and IGBT Driver
- Driver for Temperature Controller

Ordering Information

PART NUMBER	TEMP. RANGE (°C)	PACKAGE	PKG. NO.
HIP1030AS	-40 to 125	5 Ld TS-001AA SIP	Z5.067C

Description

The HIP1030 is a High Side Driver Power Integrated Circuit designed to switch power supply voltage to an output load. It is the equivalent of a PNP pass transistor operated as a protected high side current switch in the saturated ON state with low forward voltage drop at the maximum rated current. The HIP1030 has low output leakage and low idle current in the OFF state.

The Functional Block Diagram for the HIP1030 shows the protection control circuit functions of over-current, overvoltage and over-temperature. A small metal resistor senses over-current in the power supply path of the pass transistor and load. Overvoltage detection and shutdown of the output driver occurs when a comparator determines that the supply voltage has exceeded a comparator reference level. Over-temperature is sensed from a V_{BE} differential sense element that is thermally close to the output drive transistor. In addition to the input detected overvoltage protection, negative peak voltage of a switched inductive load is clamped with an internal zener diode. An internal bandgap voltage source provides a stable voltage reference over the operating temperature range, providing bias and reference control for the protection circuits.

The HIP1030 is particularly well suited for driving lamps, relays, and solenoids in automotive and industrial control applications where voltage and current overload protection at high temperatures is required. The HIP1030 is supplied in a 5 lead TS-001AA Power SIP package.

Pinout

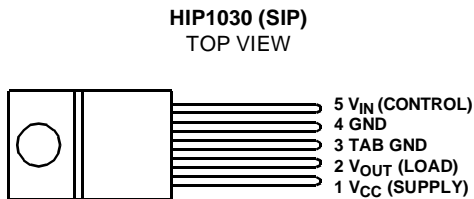

Functional Block Diagram

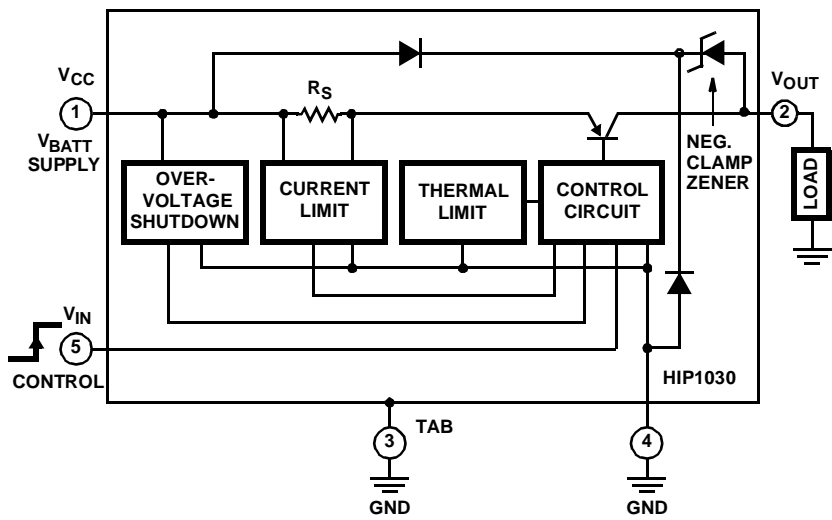

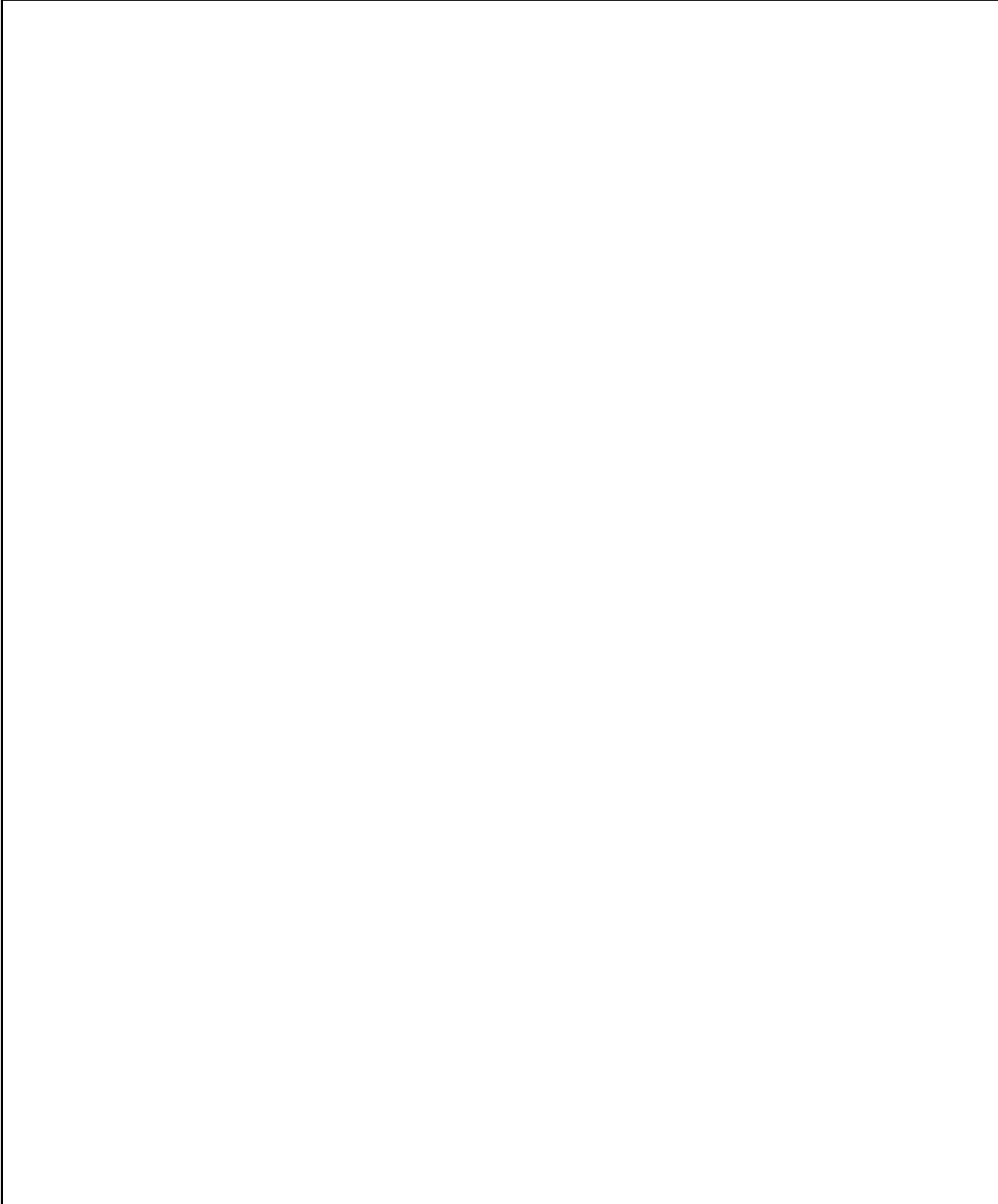

HIP1030

Absolute Maximum Ratings

Maximum Supply Voltage V_{CC} . . . See O.V. Shutdown Limit, V_{OVSD}
 Input Voltage, V_{IN} (Note 1) -1V to ($V_{CC} - 0.5V$)
 Load Current, I_{OUT} Internal Limiting
 Load Dump (Survival) $\pm 60V_{PEAK}$
 Reverse Battery -16V

Operating Conditions

Temperature Range -40°C to 125°C

Thermal Information

Thermal Resistance (Typical, Note 2) θ_{JA} (°C/W) θ_{JC} (°C/W)
 Plastic SIP Package 50 4
 Maximum Power Dissipation (Note 3)
 At $T_A = 125^\circ C$, Infinite Heat Sink 6.25W
 Maximum Junction Temperature, T_J 150°C
 Maximum Storage Temperature Range -40°C to 150°C
 Maximum Lead Temperature (Soldering 10s) 300°C
 (Lead Tips Only)

CAUTION: Stresses above those listed in "Absolute Maximum Ratings" may cause permanent damage to the device. This is a stress only rating and operation of the device at these or any other conditions above those indicated in the operational sections of this specification is not implied.

NOTES:

1. The Input Control Voltage, V_{IN} shall not be greater than ($V_{CC} - 0.5V$) and shall not exceed +7V when V_{CC} is greater than 7.5V.
2. θ_{JA} is measured with the component mounted on an evaluation PC board in free air.
3. The worst case thermal resistance, θ_{JC} for the SIP TS-001AA 5 lead package is 4°C/W. The calculation for dissipation and junction temperature rise due to dissipation is:

$$P_D = (V_{CC} - V_{OUT})(I_{OUT}) + (V_{CC})(I_{CCMAX} - I_{OUT}) \text{ or } (V_{CC})(I_{CCMAX}) - (V_{OUT})(I_{OUT})$$

$$T_J = T_{AMBIENT} + (P_D)(\theta_{JC}) \text{ for an infinite Heat Sink.}$$

Refer to Figure 1 for Derating based on Dissipation and Thermal Resistance. Derating from 150°C is based on the reciprocal of thermal resistance, $\theta_{JC} + \theta_{HS}$. For example: Where $\theta_{JC} = 4^\circ C/W$ and given $\theta_{HS} = 6^\circ C/W$ as the thermal resistance of an external Heat Sink, the junction-to-air thermal resistance, $\theta_{JA} = 10^\circ C/W$. Therefore, for the maximum allowed dissipation, derate 0.1W/°C for each degree from T_{AMB} to the maximum rated junction temperature of 150°C. If $T_{AMB} = 100^\circ C$, the maximum P_D is $(150 - 100) \times 0.1W/^\circ C = 5W$.

Electrical Specifications $T_A = -40^\circ C$ to $125^\circ C$, $V_{IN} = 2V$, $V_{CC} = +12V$, Unless Otherwise Specified

PARAMETER	SYMBOL	TEST CONDITIONS	MIN	TYP	MAX	UNITS
Operating Voltage Range	V_{CC}		4.5	-	25	V
Over-Voltage Shutdown	V_{OVSD}	$R_L = 1K\Omega$; $V_{IN} = 2V$	26	33	38	V
Over-Temperature Limiting	T_{SD}		-	150	-	°C
Negative Pulse Output Clamp Voltage	V_{CL}	$I_{CL} = -100mA$; $V_{CC} = 4.5V$ to 25V	($V_{CC} - 35$)	($V_{CC} - 30.5$)	($V_{CC} - 28$)	V
Short Circuit Current Limiting	I_{SC}	(Note 4)	1.1	1.6	2.5	A
Input Control ON	V_{IH}		2.0	-	-	V
Input Control OFF	V_{IL}		-	-	0.8	V
Input Current High	I_{IH}	$V_{IN} = 5.5V$, $V_{CC} = 6V$ to 24V	6	-	40	μA
Input Current Low	I_{IL}	$V_{IN} = 0.8V$, $V_{CC} = 6V$ to 24V	6	-	30	μA
Supply Current, Full Load Input Control ON	I_{CCMAX}	$V_{IN} = 2V$; $I_{OUT} = 1.0A$;	-	1.05	1.1	A
Supply Current, No Load Input Control OFF	I_{CCMIN}	$V_{IN} = 0V$; $I_{OUT} = 0A$;	-	55	100	μA
Input-Output Forward Voltage Drop ($V_{CC} - V_{OUT}$)	V_{SAT}	$I_{OUT} = 1A$; $V_{CC} = 4.5V$ to 25V	-	0.6	1	V
Output Leakage	I_{OUT_LK}	$V_{IN} = 0.8V$; $V_{CC} = 6V$ to 24V	-	4	50	μA
Turn ON Time	t_{ON}	$R_L = 80\Omega$; (Note 5)	-	5	20	μs
Turn OFF Time	t_{OFF}	$R_L = 80\Omega$; (Note 5)	-	25	65	μs

NOTES:

4. Short circuit current will be reduced when thermal shutdown occurs. Testing of short circuit current may require a short duration pulse. See Figure 7.
5. Refer to Figures 3A and 3B for typical switching speeds with a 20Ω Load.

Typical Applications

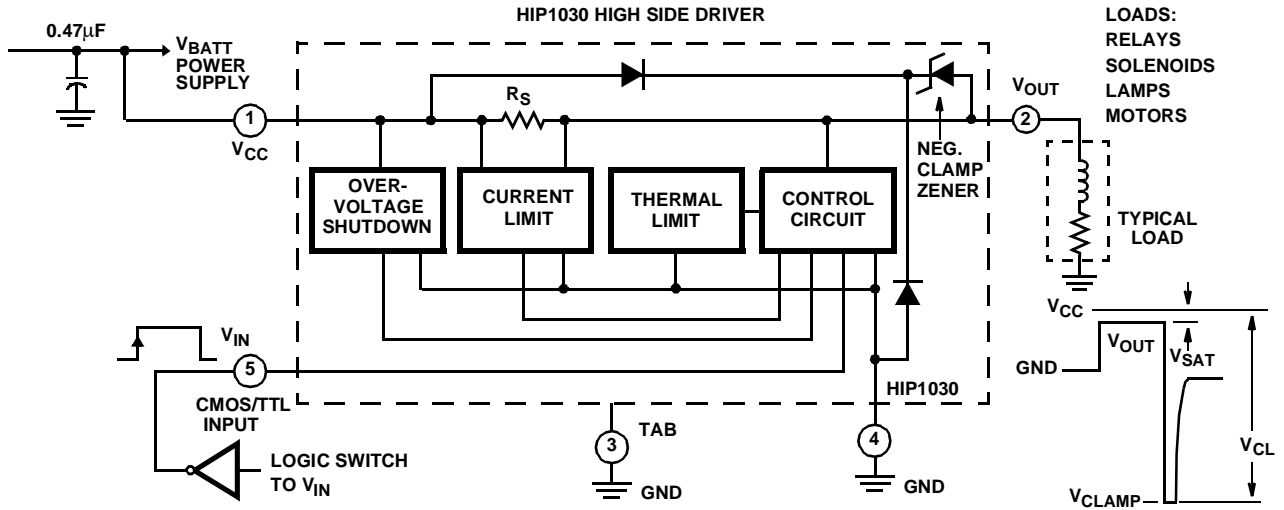

Typical Performance Curves

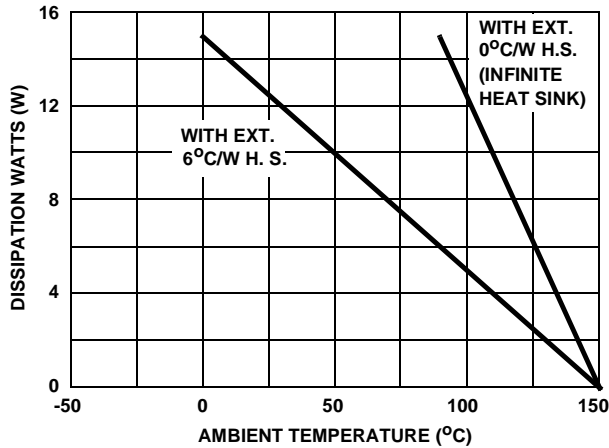

FIGURE 1. DISSIPATION DERATING CURVES

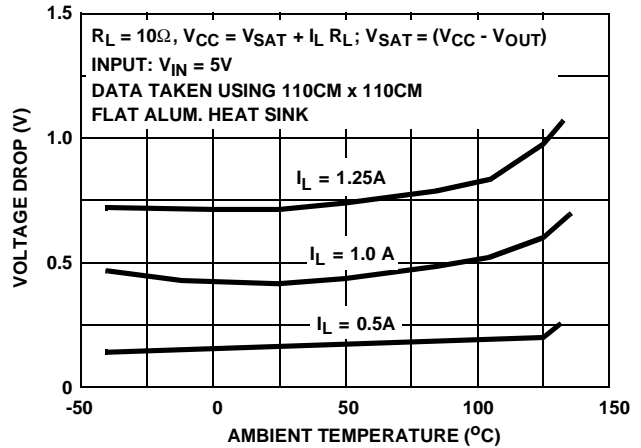

FIGURE 2. TYPICAL FORWARD VOLTAGE DROP, V_{SAT} CHARACTERISTICS vs AMBIENT OPERATING TEMPERATURE

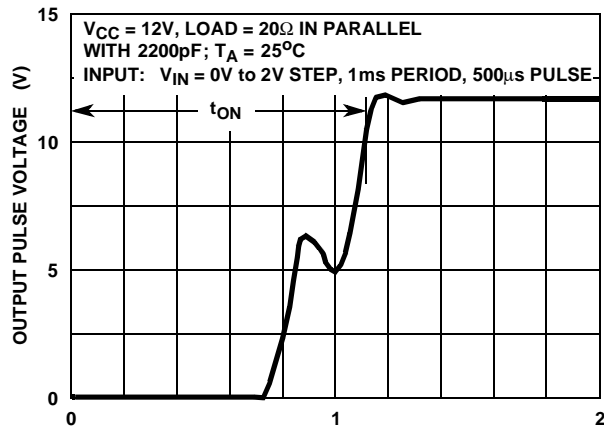

FIGURE 3A. OUTPUT TURN-ON TIME (μs)

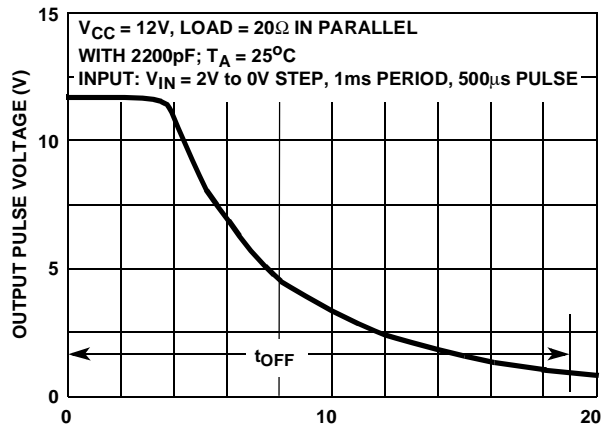

FIGURE 3B. OUTPUT TURN-OFF TIME (μs)

Typical Performance Curves (Continued)

FIGURE 3. TYPICAL RISE TIME AND FALL TIME CHARACTERISTICS OF THE HIP1030 WITH A RESISTIVE AND CAPACITIVE LOAD. THE TURN-ON TIME OF APPROXIMATELY 1.1 μ s IS PRIMARILY DETERMINED BY THE V_{CC} SUPPLY. THE OUTPUT FALL TIME IS LIMITED BY RC TIME CONSTANT OF THE LOAD.

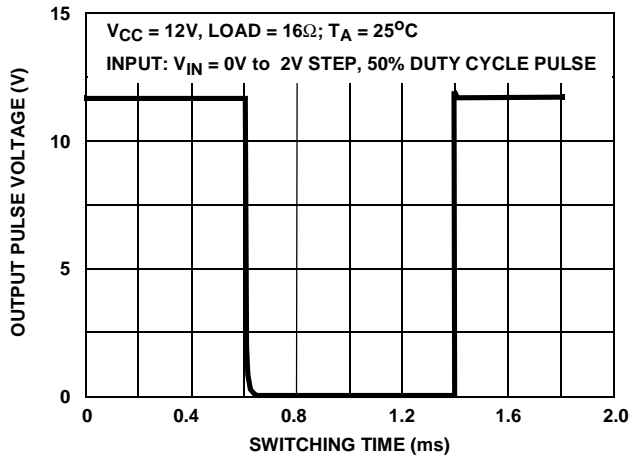

FIGURE 4. TYPICAL SWITCHING CHARACTERISTIC OF THE HIP1030 WITH AN OUTPUT RESISTIVE LOAD

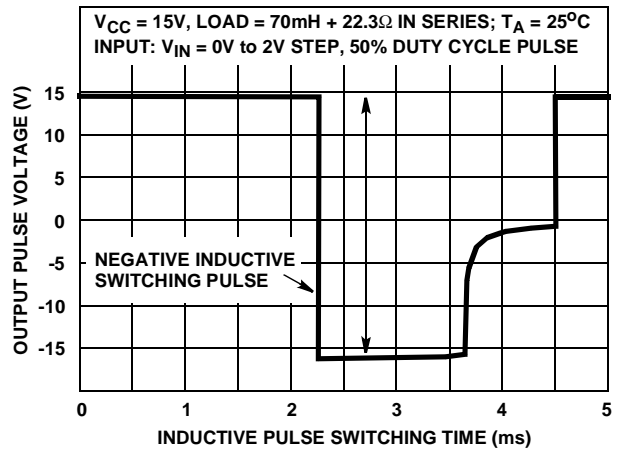

FIGURE 5. TYPICAL OUTPUT INDUCTIVE LOAD SWITCHING PULSE. THE NEGATIVE CLAMP VOLTAGE ($V_{CC} - 31V$) FOR THE INDUCTIVE KICK PULSE IS REFERENCED TO THE V_{CC} SUPPLY INPUT

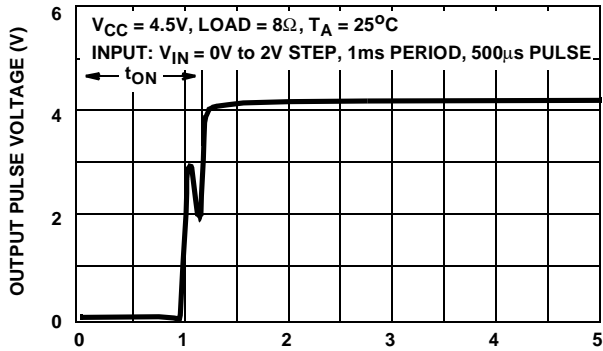

FIGURE 6A. TURN-ON TIME (μ s)

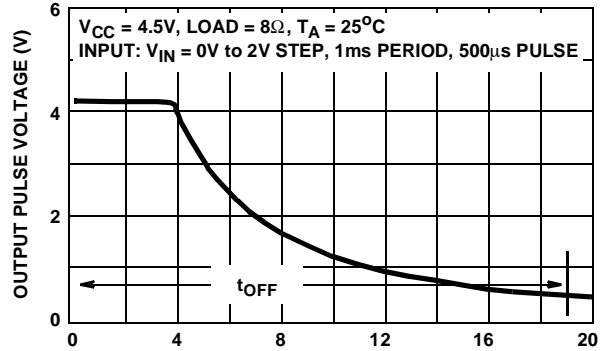

FIGURE 6B. TURN-OFF TIME (μ s)

FIGURE 6. TYPICAL LOW SUPPLY VOLTAGE SWITCHING CHARACTERISTICS OF THE HIP1030. THE TURN-ON AND TURN-OFF CHARACTERISTICS ARE SHOWN FOR $V_{CC} = 4.5V$.

Typical Performance Curves (Continued)

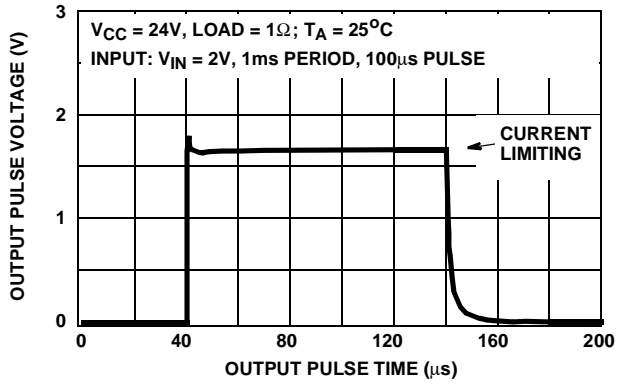

FIGURE 7. TYPICAL OUTPUT CURRENT PULSE WHEN SWITCHING INTO A LOW IMPEDANCE (1Ω), OR SHORTED LOAD. FOR THE CONDITIONS SHOWN, OUTPUT CURRENT LIMITING IS $\sim 1.7A$

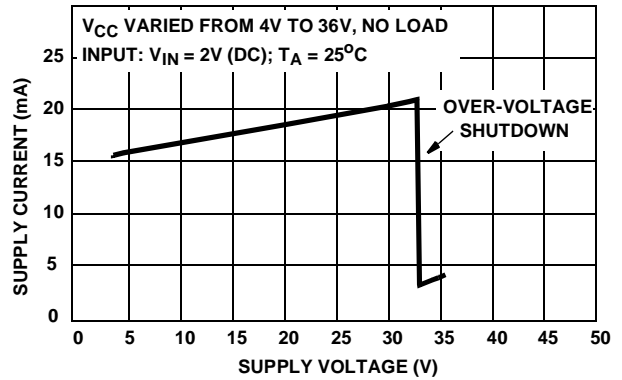
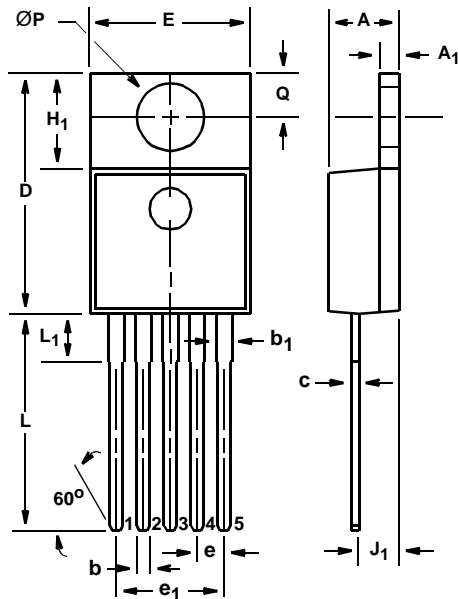

FIGURE 8. TYPICAL IDLE CURRENT vs SUPPLY VOLTAGE WITH NO LOAD

Single-In-Line Plastic Packages (SIP)



**Z5.067C (ALTERNATE VERSION)
5 LEAD PLASTIC SINGLE-IN-LINE PACKAGE**

SYMBOL	INCHES		MILLIMETERS		NOTES
	MIN	MAX	MIN	MAX	
A	0.170	0.180	4.32	4.57	-
A ₁	0.048	0.052	1.22	1.32	3, 4
b	0.030	0.034	0.77	0.86	3, 4
b ₁	0.031	0.041	0.79	1.04	3, 4
c	0.018	0.022	0.46	0.55	3, 4
D	0.590	0.610	14.99	15.49	-
E	0.395	0.405	10.04	10.28	-
e	0.067 TYP		1.70 TYP		5
e ₁	0.268 BSC		6.80 BSC		5
H ₁	0.235	0.255	5.97	6.47	-
J ₁	0.095	0.105	2.42	2.66	6
L	0.530	0.550	13.47	13.97	-
L ₁	0.110	0.130	2.80	3.30	2
ØP	0.149	0.153	3.79	3.88	-
Q	0.105	0.115	2.66	2.92	-

Rev. 1 4/96

NOTES:

1. These dimensions are within allowable dimensions of Rev. A of JEDEC TS-001AA outline dated 8-89.
2. Solder finish uncontrolled in this area.
3. Lead dimension (without solder).
4. Add typically 0.002 inches (0.05mm) for solder plating.
5. Position of lead to be measured 0.250 inches (6.35mm) from bottom of dimension D.
6. Position of lead to be measured 0.100 inches (2.54mm) from bottom of dimension D.
7. Controlling dimension: Inch.

All Intersil semiconductor products are manufactured, assembled and tested under **ISO9000** quality systems certification.

Intersil products are sold by description only. Intersil Corporation reserves the right to make changes in circuit design and/or specifications at any time without notice. Accordingly, the reader is cautioned to verify that data sheets are current before placing orders. Information furnished by Intersil is believed to be accurate and reliable. However, no responsibility is assumed by Intersil or its subsidiaries for its use; nor for any infringements of patents or other rights of third parties which may result from its use. No license is granted by implication or otherwise under any patent or patent rights of Intersil or its subsidiaries.

For information regarding Intersil Corporation and its products, see web site <http://www.intersil.com>