

**PRELIMINARY**  
 Notice: This is not a final specification.  
 Some parametric limits are subject to change.

MITSUBISHI Nch POWER MOSFET

# FS20UMA-4A

HIGH-SPEED SWITCHING USE

## FS20UMA-4A

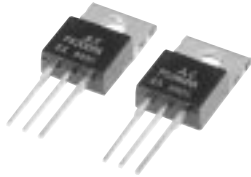

- 10V DRIVE
- $V_{DSS}$  ..... 200V
- $r_{DS(ON)}(MAX)$  .....  $0.18\Omega$
- $I_D$  ..... 20A

## OUTLINE DRAWING

Dimensions in mm

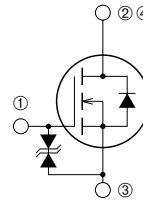
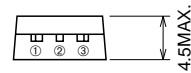
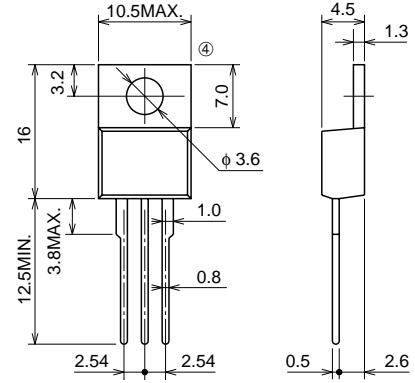

- ① GATE
- ② DRAIN
- ③ SOURCE
- ④ DRAIN

TO-220

## APPLICATION

Cs Switch for CRT Display monitor, Switch mode power supply, etc.

## MAXIMUM RATINGS (Tc = 25°C)

Symbol	Parameter	Conditions	Ratings	Unit
$V_{DSS}$	Drain-source voltage	$V_{GS} = 0V$	200	V
$V_{GSS}$	Gate-source voltage	$V_{DS} = 0V$	$\pm 20$	V
$I_D$	Drain current		20	A
$I_{DM}$	Drain current (Pulsed)		60	A
$I_{DA}$	Avalanche drain current (Pulsed)	$L = 200\mu H$	20	A
$P_D$	Maximum power dissipation		80	W
$T_{ch}$	Channel temperature		-55 ~ +150	°C
$T_{stg}$	Storage temperature		-55 ~ +150	°C
—	Weight	Typical value	2.0	g

**PRELIMINARY**  
 Notice: This is not a final specification.  
 Some parametric limits are subject to change.

**ELECTRICAL CHARACTERISTICS** (Tch = 25°C)

Symbol	Parameter	Test conditions	Limits			Unit
			Min.	Typ.	Max.	
V (BR) DSS	Drain-source breakdown voltage	Id = 1mA, VGS = 0V	200	—	—	V
V (BR) GSS	Gate-source breakdown voltage	IGS = ±10μA, VDS = 0V	±20	—	—	V
IGSS	Gate-source leakage current	VGS = ±20V, VDS = 0V	—	—	±10	μA
IdSS	Drain-source leakage current	VDS = 200V, VGS = 0V	—	—	1	mA
VGS (th)	Gate-source threshold voltage	Id = 1mA, VDS = 10V	2.0	3.0	4.0	V
rDS (ON)	Drain-source on-state resistance	Id = 10A, VGS = 10V	—	0.14	0.18	Ω
VDS (ON)	Drain-source on-state voltage	Id = 10A, VGS = 10V	—	1.40	1.80	V
yfs	Forward transfer admittance	Id = 10A, VDS = 10V	—	18.0	—	S
Ciss	Input capacitance	VDS = 25V, VGS = 0V, f = 1MHz	—	1650	—	pF
Coss	Output capacitance		—	200	—	pF
Crss	Reverse transfer capacitance		—	65	—	pF
td (on)	Turn-on delay time	VDD = 100V, Id = 10A, VGS = 10V, RGEN = RGS = 50Ω	—	20	—	ns
tr	Rise time		—	40	—	ns
td (off)	Turn-off delay time		—	290	—	ns
tf	Fall time		—	70	—	ns
VSD	Source-drain voltage	IS = 10A, VGS = 0V	—	0.95	—	V
Rth (ch-c)	Thermal resistance	Channel to case	—	—	1.56	°C/W

**PERFORMANCE CURVES**

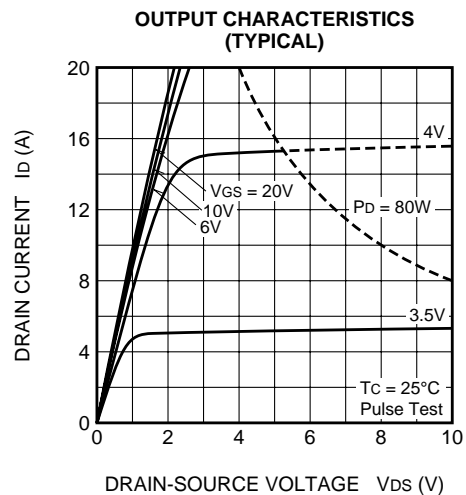
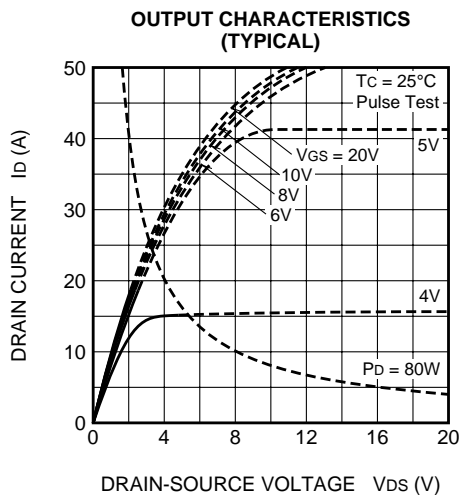
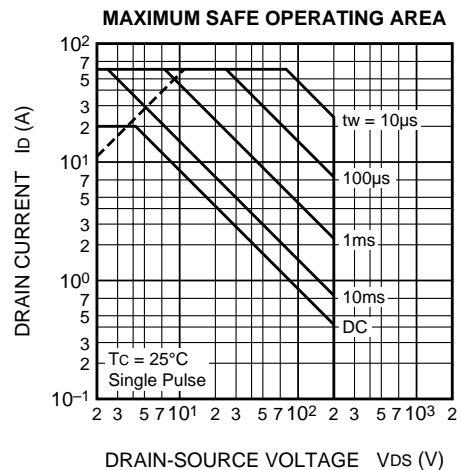
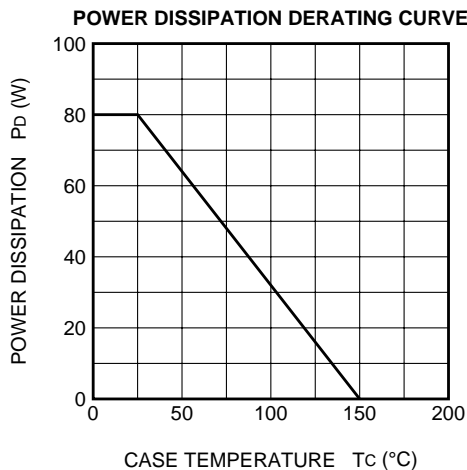

**PRELIMINARY**  
 Notice: This is not a final specification.  
 Some parametric limits are subject to change.

**ON-STATE VOLTAGE VS. GATE-SOURCE VOLTAGE (TYPICAL)**

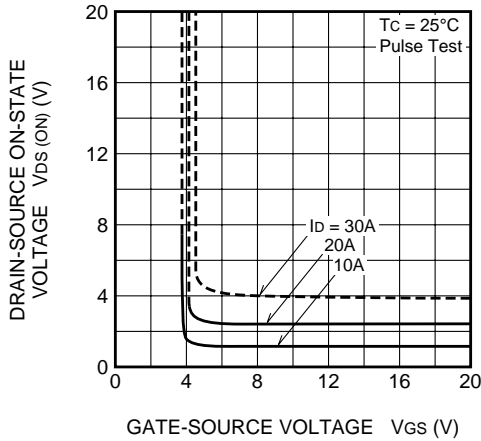

**ON-STATE RESISTANCE VS. DRAIN CURRENT (TYPICAL)**

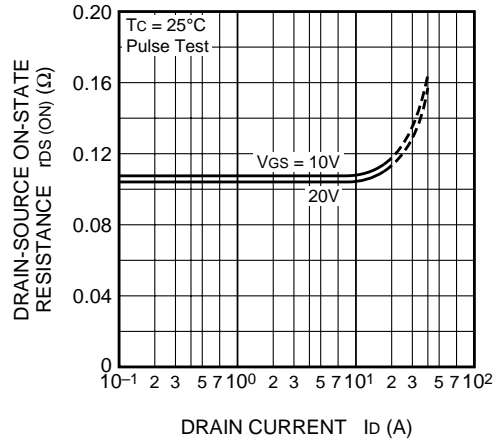

**TRANSFER CHARACTERISTICS (TYPICAL)**

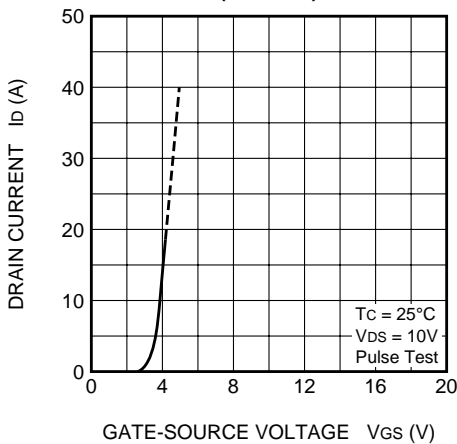

**FORWARD TRANSFER ADMITTANCE VS. DRAIN CURRENT (TYPICAL)**

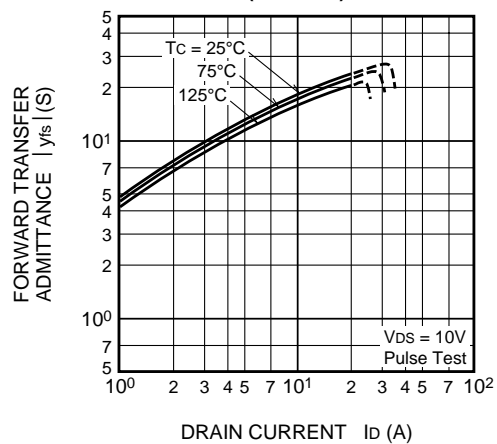

**CAPACITANCE VS. DRAIN-SOURCE VOLTAGE (TYPICAL)**

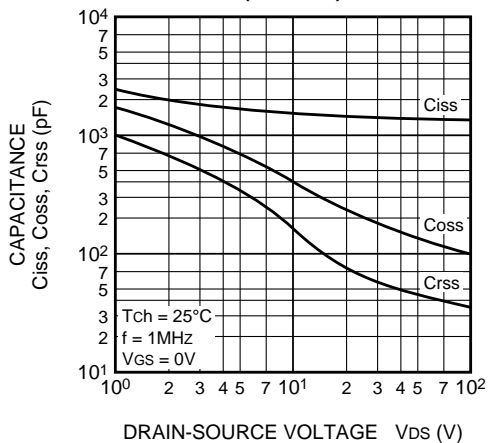

**SWITCHING CHARACTERISTICS (TYPICAL)**

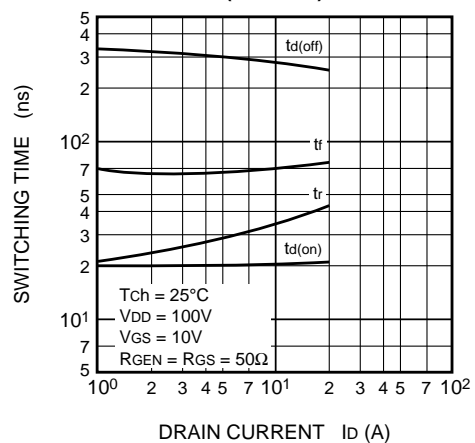

**PRELIMINARY**  
 Notice: This is not a final specification.  
 Some parametric limits are subject to change.

**GATE-SOURCE VOLTAGE VS. GATE CHARGE (TYPICAL)**

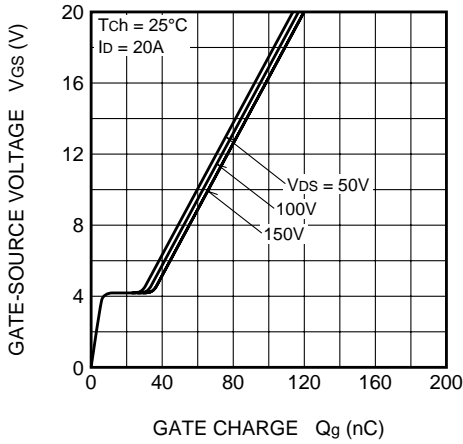

**SOURCE-DRAIN DIODE FORWARD CHARACTERISTICS (TYPICAL)**

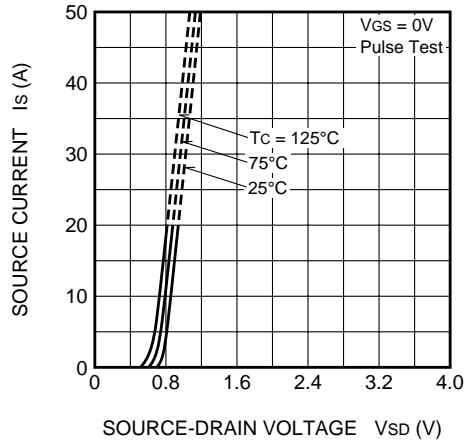

**ON-STATE RESISTANCE VS. CHANNEL TEMPERATURE (TYPICAL)**

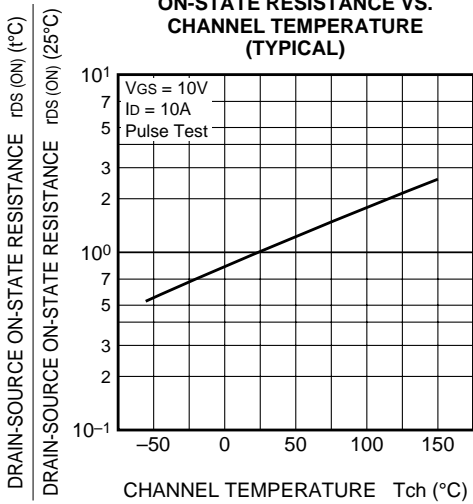

**THRESHOLD VOLTAGE VS. CHANNEL TEMPERATURE (TYPICAL)**

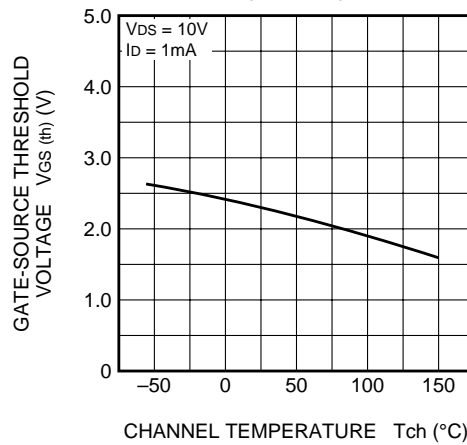

**BREAKDOWN VOLTAGE VS. CHANNEL TEMPERATURE (TYPICAL)**

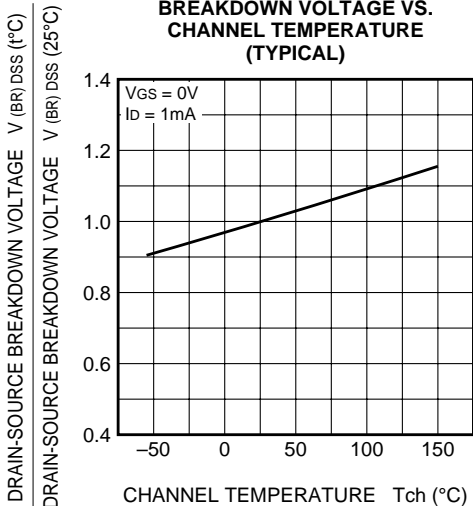

**TRANSIENT THERMAL IMPEDANCE CHARACTERISTICS**

