

# 1,550nm Modulator Integrated DFB Laser

# FLD5F20NP-E

## FEATURES

- Modulator Integrated DFB Laser Diode Module
- CW operation of DFB laser section
- Modulation voltage applied only to modulator section
- High speed butterfly package with GPO connection
- Built-in optical isolator, monitor photodiode, thermistor, and thermo-electric cooler
- Available at C-Band ITU-T grid wavelengths between 1529.55nm thru 1563.05nm

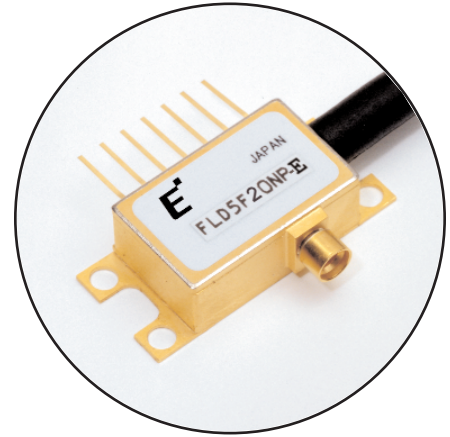

## APPLICATION

This MI DFB laser is intended for long reach applications ( $\leq 80$ km) at 10Gb/s.

## DESCRIPTION

The Modulator Integrated DFB Laser (MI DFB Laser) has an electro-absorption modulator monolithically integrated with a conventional Distributed Feed-Back (DFB) laser. The modulation voltage is applied to the modulator section while the laser section operates CW allowing extremely low wavelength chirping. Extinction ratios of more than 10 dB can be achieved with 2.6 Vp-p modulation. The MI laser is installed in a butterfly type package. The module incorporates a highly stable optical coupling system. The module includes an optical isolator, monitor photodiode, thermistor and a thermo-electric cooler.

## ABSOLUTE MAXIMUM RATINGS ( $T_{op}=25^{\circ}\text{C}$ , unless otherwise specified)

Parameter	Symbol	Condition	Rating		Unit
			Min.	Max.	
Storage Temperature	$T_{stg}$	-	-40	+85	$^{\circ}\text{C}$
Operating Case Temperature	$T_{op}$	-	-20	+70	$^{\circ}\text{C}$
Optical Output Power	$P_f$	CW	-	5	mW
Laser Forward Current	$I_F$	CW	-	150	mA
Laser Reverse Voltage	$V_R$	CW	-	2	V
Modulator Forward Voltage	$V_m$	CW	-5	+1	V
Photodiode Forward Current	-	-	-	1	mA
Photodiode Reverse Voltage	$V_{DR}$	-	-	10	V
TEC Voltage	$V_c$	Cooling	-	+2.5	V
		Heating	-2.5	-	
TEC Current	$I_c$	Cooling	-	+1.4	A
		Heating	-0.9	-	
Thermistor Temperature	$T_{th}$	ATC Operation	-20	+70	$^{\circ}\text{C}$
Lead Soldering Time	-	260 $^{\circ}\text{C}$	-	10	sec

## OPTICAL & ELECTRICAL CHARACTERISTICS (T<sub>L</sub> = T<sub>set</sub>, T<sub>c</sub> = 25°C, BOL, unless otherwise specified)

Parameter	Symbol	Test Condition	Limits			Unit
			Min.	Type	Max.	
Peak Wavelength	$\lambda_p$		Note (4)			nm
Threshold Current	$I_{th}$	CW, $V_m=V_o$	-	-	30	mA
Operating Current	$I_{op}$		40	-	100	mA
Forward Voltage	$V_F$	CW, $I_F=I_{op}$	-	1.4	2.0	V
Optical Output Power (Avg. Power)	$P_f$	Note (1)	-2.0	-	-	dBm
Dispersion Penalty	$dP$		-	-	2	dB
Sidemode Suppression Ratio	SSR	Note (2)	35	-	-	dB
Wavelength Drift	-	after 20 years	-0.1	-	0.1	nm
Wavelength Stability with Case Temperature	-	-	-	-	$\pm 1.0$	pm/°C
Optical Isolation	$I_s$	T <sub>c</sub> =-20 to +70°C	25	35	-	dB
On Level Modulation	$V_o$	-	-0.7	-	0	V
Modulator Drive Voltage	$V_{mod}$	( $V_o-V_{mod}$ ) $\geq$ -3.3V, R <sub>ext</sub> =10dB	-	-	2.6	V
Extinction Ratio	R <sub>ext</sub>	$I_F=I_{op}$ , $V_m=V_o$ (at On Level) $V_m=V_o-V_{mod}$ (at Off Level)	10	-	-	dB
Rise Time	$T_r$	$I_F=I_{op}$ , $V_m=V_o$ , 20 to 80%	-	20	25	ps
Fall Time	$T_f$		-	20	25	ps
Cut-off Frequency	S <sub>21</sub>	-3dB bandwidth, $V_m=V_o-0.5I_Vmod$ I, $I_F=I_{op}$	10	-	-	GHz
In-Band Ripple	$\Delta G$	$I_F=I_{op}$ , f=0.1-10GHz, $V_m=V_o-0.5I_Vmod$ I	-	-	$\pm 1.0$	dB
RF Return Loss	S <sub>11</sub>	f=DC-5GHz, 50Ω Test Set, $V_m=V_o$ , $I_F=I_{op}$	8	-	-	dB
RF Return Loss	S <sub>11</sub>	f=5-10GHz, 50Ω Test Set, $V_m=V_o$ , $I_F=I_{op}$	5	-	-	dB
Relative Intensity Noise	RIN	f=10 MHz to 8.5 GHz, $V_m=V_o$ , $I_F=I_{op}$ , 8% Reflection	-	-	-120	dB/Hz
TEC Capacity	$\Delta T$	P <sub>TEC</sub> =3.3W, $I_F=I_{op}$	70-T <sub>set</sub>	-	-	°C
TEC Current	I <sub>TEC</sub>	$I_F=I_{op}$ , $\Delta T=(70-T_{set})[°C]$	-	-	1.3	A
TEC Voltage	V <sub>TEC</sub>	$I_F=I_{op}$ , $\Delta T=(70-T_{set})[°C]$	-	-	2.5	V
TEC Power Dissipation	P <sub>TEC</sub>	$I_F=I_{op}$	-	-	3.3	W
Thermal Resistance	R <sub>th</sub>	T <sub>L</sub> =25°C, T <sub>c</sub> =+25°C	9.5	10.0	10.5	kΩ
Thermistor B Constant (Note 3)	B		3,270	3,450	3,630	K

Note (1) Eudyna Test System  
9.95328Gb/s, PRBS=2<sup>23</sup>-1,  $I_F=I_{op}$ ,  $V_m=V_o$  and ( $V_o-V_{mod}$ )  
Dispersion=1600ps/nm, Dispersion penalty at  
Bit Error Rate = 1.0E-10

Note (2) Eudyna Test System  
9.95328Gb/s, PRBS=2<sup>23</sup>-1,  $I_F=I_{op}$ ,  $V_m=V_o$  and ( $V_o-V_{mod}$ )

Note (3) Relation between resistance and temperature (°K) is:  $R_{th}(T) = R_{th}(25°C) \cdot \exp[B/(1/T - 1/298)]$

Note (4) Reference Table 1 for Wavelength Table

**Fig. 1 Lasing Spectrum**

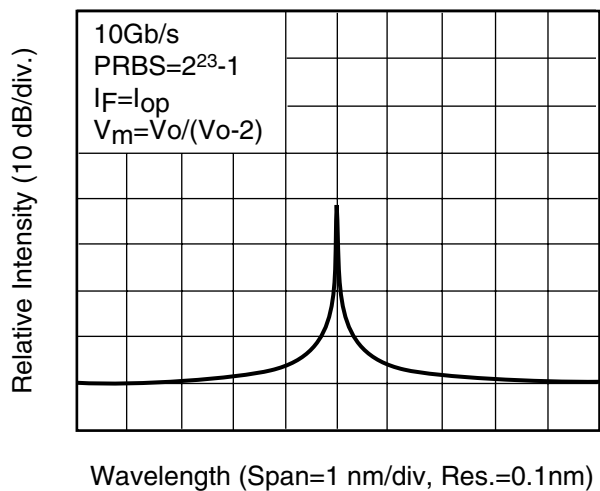

**Fig. 2 Output Power & Monitor Current vs. Forward Current**

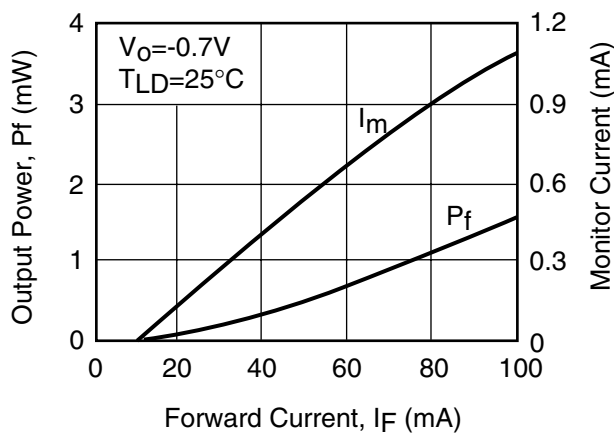

Fig. 3 Extinction Ratio vs. Modulation Applied Voltage

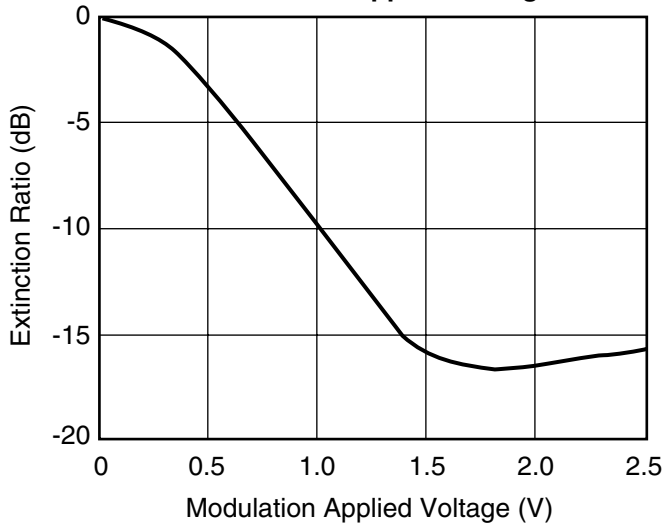

Fig. 4 Cut-off Frequency (S21)

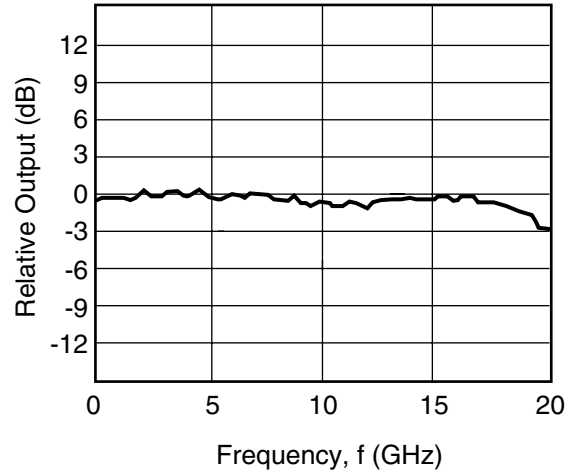

Fig. 5 RF Return Loss (S11)

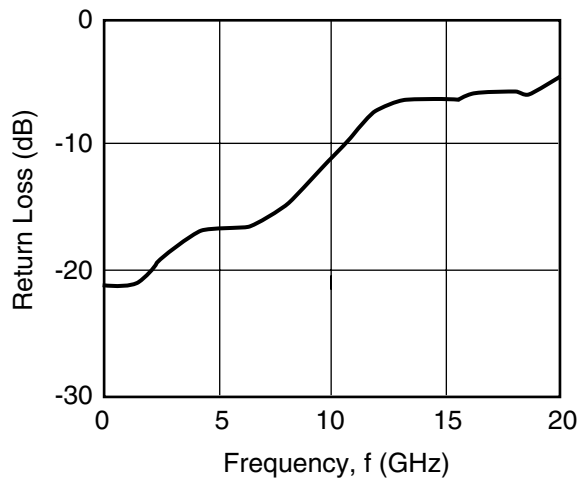
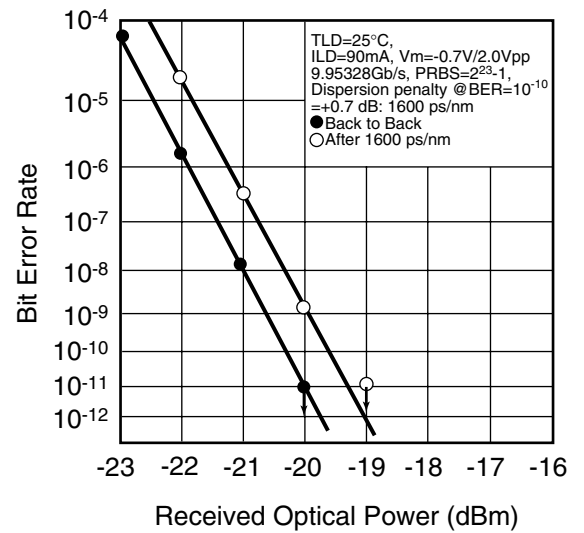
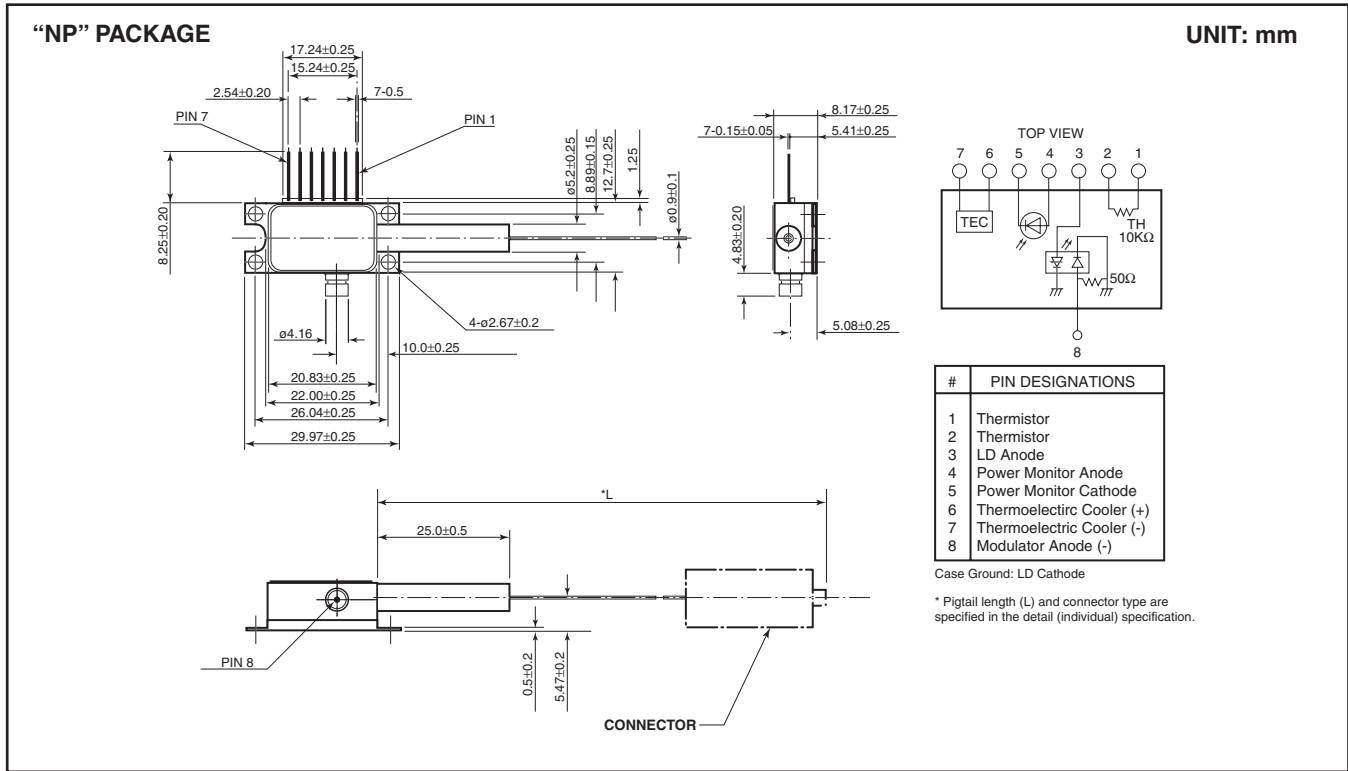

Fig. 6 Transmission Characteristics



**Table 1 Wavelength Table**

Part Number	Wavelength (nm) (TL=Tset) (in vacuum)	Frequency (THz)	Tolerance (nm)
FLD5F20NP-E60	1529.55	196.00	±0.1
FLD5F20NP-E59	1530.33	195.90	±0.1
FLD5F20NP-E58	1531.12	195.80	±0.1
FLD5F20NP-E57	1531.90	195.70	±0.1
FLD5F20NP-E56	1532.68	195.60	±0.1
FLD5F20NP-E55	1533.47	195.50	±0.1
FLD5F20NP-E54	1534.25	195.40	±0.1
FLD5F20NP-E53	1535.04	195.30	±0.1
FLD5F20NP-E52	1535.82	195.20	±0.1
FLD5F20NP-E51	1536.61	195.10	±0.1
FLD5F20NP-E50	1537.40	195.00	±0.1
FLD5F20NP-E49	1538.19	194.90	±0.1
FLD5F20NP-E48	1538.98	194.80	±0.1
FLD5F20NP-E47	1539.77	194.70	±0.1
FLD5F20NP-E46	1540.56	194.60	±0.1
FLD5F20NP-E45	1541.35	194.50	±0.1
FLD5F20NP-E44	1542.14	194.40	±0.1
FLD5F20NP-E43	1542.94	194.30	±0.1
FLD5F20NP-E42	1543.73	194.20	±0.1
FLD5F20NP-E41	1544.53	194.10	±0.1
FLD5F20NP-E40	1545.32	194.00	±0.1
FLD5F20NP-E39	1546.12	193.90	±0.1
FLD5F20NP-E38	1546.92	193.80	±0.1
FLD5F20NP-E37	1547.72	193.70	±0.1
FLD5F20NP-E36	1548.51	193.60	±0.1
FLD5F20NP-E35	1549.32	193.50	±0.1
FLD5F20NP-E34	1550.12	193.40	±0.1
FLD5F20NP-E33	1550.92	193.30	±0.1
FLD5F20NP-E32	1551.72	193.20	±0.1
FLD5F20NP-E31	1552.52	193.10	±0.1
FLD5F20NP-E30	1553.33	193.00	±0.1
FLD5F20NP-E29	1554.13	192.90	±0.1
FLD5F20NP-E28	1554.94	192.80	±0.1
FLD5F20NP-E27	1555.75	192.70	±0.1
FLD5F20NP-E26	1556.56	192.60	±0.1
FLD5F20NP-E25	1557.36	192.50	±0.1
FLD5F20NP-E24	1558.17	192.40	±0.1
FLD5F20NP-E23	1558.98	192.30	±0.1
FLD5F20NP-E22	1559.79	192.20	±0.1
FLD5F20NP-E21	1560.61	192.10	±0.1
FLD5F20NP-E20	1561.42	192.00	±0.1
FLD5F20NP-E19	1562.23	191.90	±0.1
FLD5F20NP-E18	1563.05	191.80	±0.1



For further information please contact:

### Eudyna Devices USA Inc.

2355 Zanker Rd.  
San Jose, CA 95131-1138, U.S.A.  
TEL: (408) 232-9500  
FAX: (408) 428-9111  
[www.us.eudyna.com](http://www.us.eudyna.com)

### Eudyna Devices Europe Ltd.

Network House  
Norreys Drive  
Maidenhead, Berkshire SL6 4FJ  
United Kingdom  
TEL: +44 (0) 1628 504800  
FAX: +44 (0) 1628 504888

### Eudyna Devices Asia Pte Ltd.

Hong Kong Branch  
Rm. 1101, Ocean Centre, 5 Canton Rd.  
Tsim Sha Tsui, Kowloon, Hong Kong  
TEL: +852-2377-0227  
FAX: +852-2377-3921

### Eudyna Devices Inc.

Sales Division  
1, Kanai-cho, Sakae-ku  
Yokohama, 244-0845, Japan  
TEL: +81-45-853-8156  
FAX: +81-45-853-8170

### CAUTION

Eudyna Devices Inc. products contain **gallium arsenide (GaAs)** which can be hazardous to the human body and the environment. For safety, observe the following procedures:

- Do not put this product into the mouth.
- Do not alter the form of this product into a gas, powder, or liquid through burning, crushing, or chemical processing as these by-products are dangerous to the human body if inhaled, ingested, or swallowed.
- Observe government laws and company regulations when discarding this product. This product must be discarded in accordance with methods specified by applicable hazardous waste procedures.

Eudyna Devices Inc. reserves the right to change products and specifications without notice. The information does not convey any license under rights of Eudyna Devices Inc. or others.

© 2004 Eudyna Devices USA Inc.  
Printed in U.S.A.