

Title	<i>Engineering Prototype Report (EPR-9)</i> <i>5 W, Universal Input, Dual Output, Isolated, TNY266 (EP9)</i>
Target Applications	Home Appliance Market
Author	S.L.
Document Number	EPR-9
Date	03-April-2001
Revision	8

Abstract

This document presents the specification, schematic & BOM, transformer calculation, test data, waveforms and EMI scan for a low cost, isolated converter for a home appliance application.

Table Of Contents

1	Introduction	3
2	Power Supply Requirements Specification	3
3	Schematic	4
3.1	Configuration "1" 2 kV	4
3.2	Configuration "2" 6 kV	5
4	Circuit Description	6
5	Layout and Picture	7
6	Bill Of Materials	9
6.1	Configuration "1", 2 kV	9
6.2	Configuration "2", 6 kV	9
7	Transformer – T1	10
7.1	Transformer Drawing	10
7.2	Electrical Specifications	10
7.3	Transformer Construction	10
7.4	Transformer Materials	11
7.5	Transformer Winding Instructions	11
7.6	Transformer Bobbin Dimensions	12
7.7	Transformer Spreadsheet	13
8	Performance Data	15
8.1	Efficiency	15
8.2	Regulation @ 25 °C Ambient	16
8.3	Temperature	17
8.4	Waveforms (2 kV config."1")	18
8.4.1	Turn-on Delay/Hold-up Time	18
8.4.2	Auto-Restart	19
8.5	Transient Response	21
8.6	Conducted EMI Scans	22
8.7	Surge Voltage Immunity (2 kV and 6 kV, 1.2/50 μ s per IEC1000-4-5)	23
8.8	Acoustic Emissions	24
Appendix A	Example of 24 V Output Design	25
Appendix A1.1	Schematic of 24 V Design	25
Appendix A1.2	Bill of Materials (5 W, 5 V _{DC} , 24 V _{DC} PS)	26
Appendix A1.3	Transformer Spreadsheet	27
9	Revision History	29

Important Note:

Although the EP-9 is designed to satisfy safety isolation requirements, the engineering prototype has not been agency approved. Therefore all testing should be performed using an isolation transformer to provide the AC input to the prototype board.



1 Introduction

This document presents the specification, schematic & BOM, transformer design, test data, waveforms and EMI scan for a low cost, dual output (5 V_{DC}, 12 V_{DC}), isolated converter for a home appliance application. The unit has to operate up to 85 °C ambient and to ride through input voltage surges up to 2 kV (config. "1") or to 6 kV (config. "2").

The unit is also designed to meet the industry safety and EMI standards. The EMI standard is met with a low cost transformer (without shield winding and flux band) and low cost input filter (no common mode choke).

There are different input voltage surge withstand requirements depending upon the geographical area the white goods are built for. The power supply designer has to choose the level of protection, the voltage level and the number of surges the unit must survive.

For applications with elevated ambient temperature requiring full power, the heat sink (included in the kit) has to be soldered to the board in the slot next to U1.

The board is accompanied by a kit that includes a copper heat sink (Fig. 5.2) and the input voltage surge protection components (R7, R8, RV1) for 6 kV (config. "2") protection.

For applications requiring 5 V_{DC} and 24 V_{DC}, a schematic, BOM and transformer spreadsheet is included in Appendix A.

2 Power Supply Requirements Specification

Description	Symbol	Min	Typ	Max	Units	Comment
Input Input Voltage	V _{AC}	85		265	V _{AC}	50/60 Hz
Output Output 1 Voltage	V _{DC OUT}	10.2	12	13.8	V	(12 V±15%)
Output 1 Ripple Voltage	V _{OUT RIPPLE}		100	150	mV	@ full load
Output 1 Current	I _{OUT}	20		200	mA	
Output 2 Voltage	V _{DC OUT}	4.75	5	5.25	V	(-5 V±5%)
Output 2 Ripple Voltage	V _{OUT RIPPLE}		40	50	mV	@ full load
Output 2 Current	I _{OUT}	20		500	mA	
Power Output Continuous Output Power	P _{OUT}	0.3		2.8	W	85° C ambient* inside box
Power supply efficiency	η	0.3		5.0	W	50° C ambient* inside box
		55			%	@ low line, full load
Environmental Temperature	T _{AMB}	0		85**	°C	6"x6"x4" sealed enclosure
Input Surge Voltage Withstand	config. "1"	±2			kV	IEC1000-4-5 (1.2/50 μs)
	config. "2"	±6			kV	IEC1000-4-5 (1.2/50 μs)
Safety EMI-Conducted						IEC950 CISPR22B ***

*The unit was placed in a 6" x 6" x 4" sealed box inside the temperature chamber.

**See Paragraph 4.0.

*** FCC accepts CISPR22B @ 115 V_{AC} in place of FCC limit.



3 Schematic

3.1 Configuration "1" 2 kV

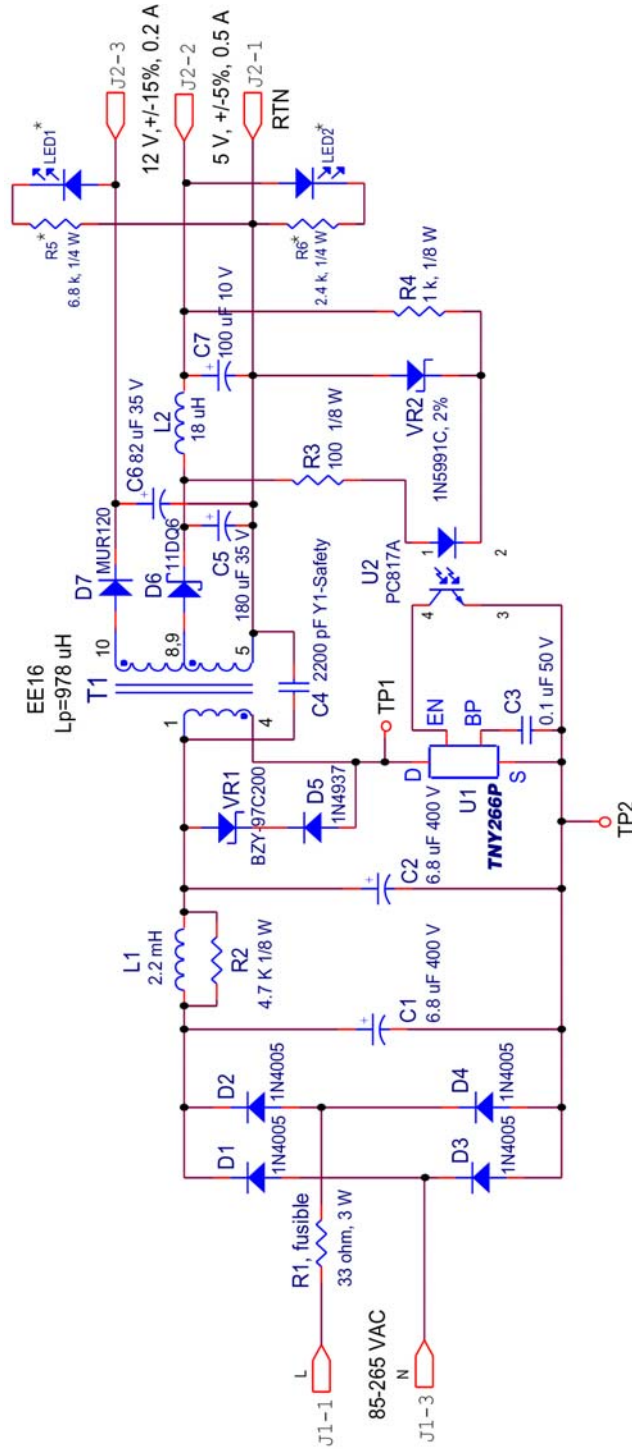

Power Integrations Inc.	
Title	Home Appliance, 5 W, dual output TNY266 PS (EP9)
Size	Document Number
Date:	2 kV (1.2/50 usec) surge protection (configuration 1)
	Thursday, April 19, 2001
Sheet	1 of 2
Rev	J

* OPTIONAL



4 Circuit Description

This circuit was designed for Home Appliance applications. The design for this had three main drivers: low cost, high ambient temperature operation and input voltage surge withstand.

There are two input protection configurations, "1" (2 kV surge) on page 4 and "2" (6 kV) on page 5.

Configuration "1" has a 33 Ω , 3 W fusible resistor (R1) which limits the 2 kV voltage surge current such that the peak charging voltage on C2 does not exceed the breakdown voltage of U1 (TNY266). R1 also functions as a fuse, opening any short that might occur on the primary side. (Pico II, series 263, Littelfuse or TR5, series 370, Wickmann) can be used (if R1 is unavailable in low wattage to ensure fusing).

- Configuration "2" has two 47 Ω , energy rated resistors (R7, R8), which, along with the varistor RV1, form a voltage divider. The life of RV1 is endless if its energy rating is not exceeded (see Fig. 8.7.1). The energy rated resistors R7, R8 are not fusible and the short circuit current being limited (~ 0.9 A at 85 V_{AC}) by R7, R8 (94 Ω), and a 0.5 A fast acting fuse

The efficiency of the 6 kV configuration can be improved at the expense of the total number of 6 kV surges protection, by reducing the value of R7, R8 up to zero.

Downstream of the input protection circuits, the operation of the two configurations is identical.

In this Home Appliance application (refer to page 4 or 5 of this report), the AC input is rectified and filtered by D1-D4, C1 and C2 to create a high voltage DC buss which is connected to T1. Inductor L1 forms a pi-filter in conjunction with C1 and C2. The resistor R2 damps resonance in inductor L1. The frequency jitter in U1 allows the unit to meet worldwide conducted EMI standards using a simple pi-filter in combination with a small value Y1-capacitor C4 and a proper PCB layout. The built-in circuitry of U1 practically eliminates the audio noise permitting the use of ordinary varnished transformers. VR1 and D5 form a clamp circuit that limits the turn-off voltage spike to a safe level on the U1-DRAIN pin.

The secondary windings are stacked to improve the cross regulation. The 5 V winding is rectified and filtered by D6, C5 with additional filtering provided by L2, C7 to give the 5 V_{DC} output. The 5 V_{DC} output voltage is determined by the sum of the voltage drops across the optocoupler U2 and the Zener diode VR2. Resistor R3 (AC gain of the circuit) limits the current through U2, improving its response time. Resistor R4 sets the bias current for VR2. The 12 V winding is rectified and filtered by D7, C6 to provide the 12 V_{DC} output. A minimum loading is necessary on the two outputs to keep them within the specified limits.

The primary-to-secondary isolation is provided by using parts/materials (opto/transformer insulation) with the correct level of isolation and creepage distances (opto slot/transformer bobbin). Also the C4 value (while allowing common mode noise current path) has to keep the leakage current below the standard (IEC950) accepted value.

The 5 V_{DC} and 12 V_{DC} monitoring light emitting diodes (LED2, LED1) and R6, R5 are optional, and have been included in this circuit for troubleshooting convenience.

The board has a small, secondary side prototyping area for alternate voltage regulation control. Test points TP1 (U1-SOURCE) and TP2 (U1-DRAIN) are provided for ease of monitoring V_{DS}. TP2 jumper can be replaced with a longer one to allow a current probe insertion for I_d monitoring.



5 Layout and Picture

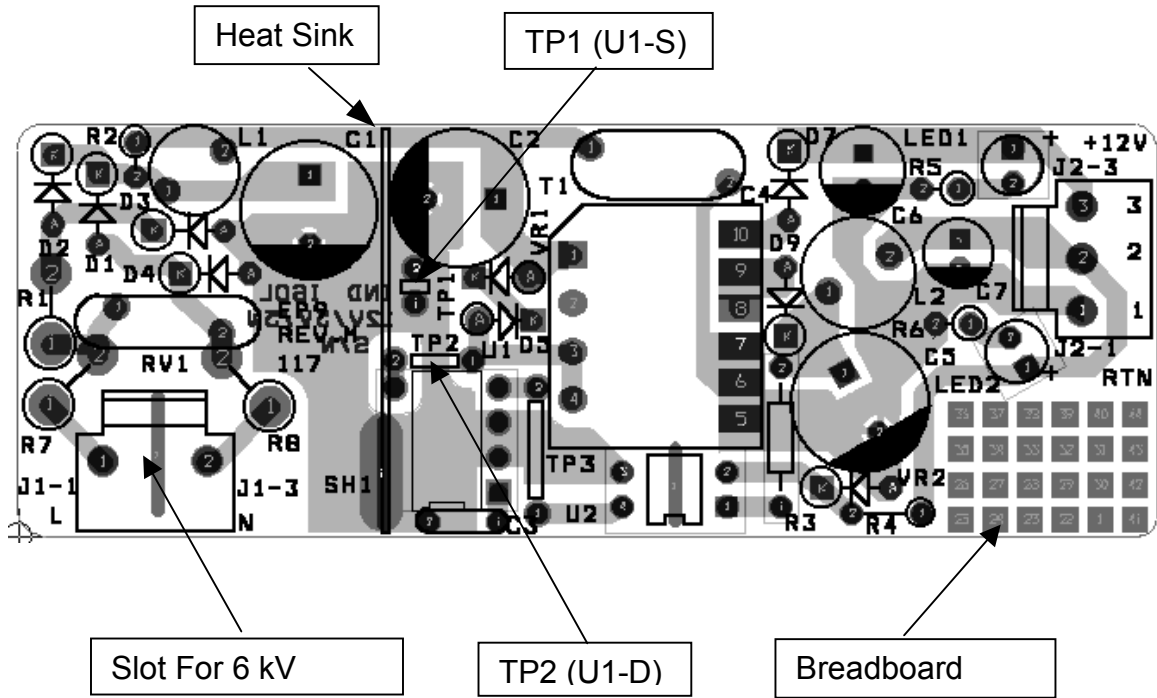

Figure 5.1 - Footprint (3.3"X1.2"), With or Without (Derated At 85 °C Ambient) Heat Sink.
 - For the drain-to-source voltage waveforms connect the high voltage probe tip to TP2 and the probe ground to test point TP1.
 - For switching current waveforms replace jumper TP2 with a wire loop and use a Tektronix A6302 current probe and AM503 current probe amplifier (with TM501 power module) or equivalent.

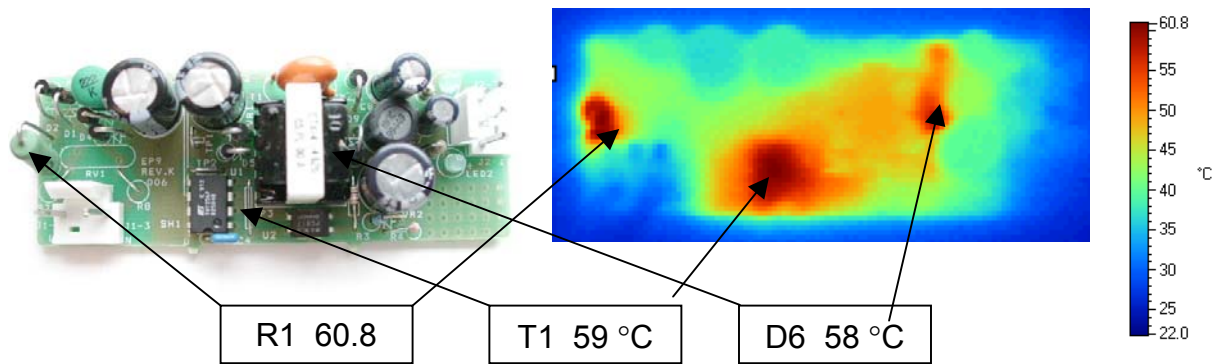

Figure 5.2 - Visible Picture.

Figure 5.3 - Infrared Picture.



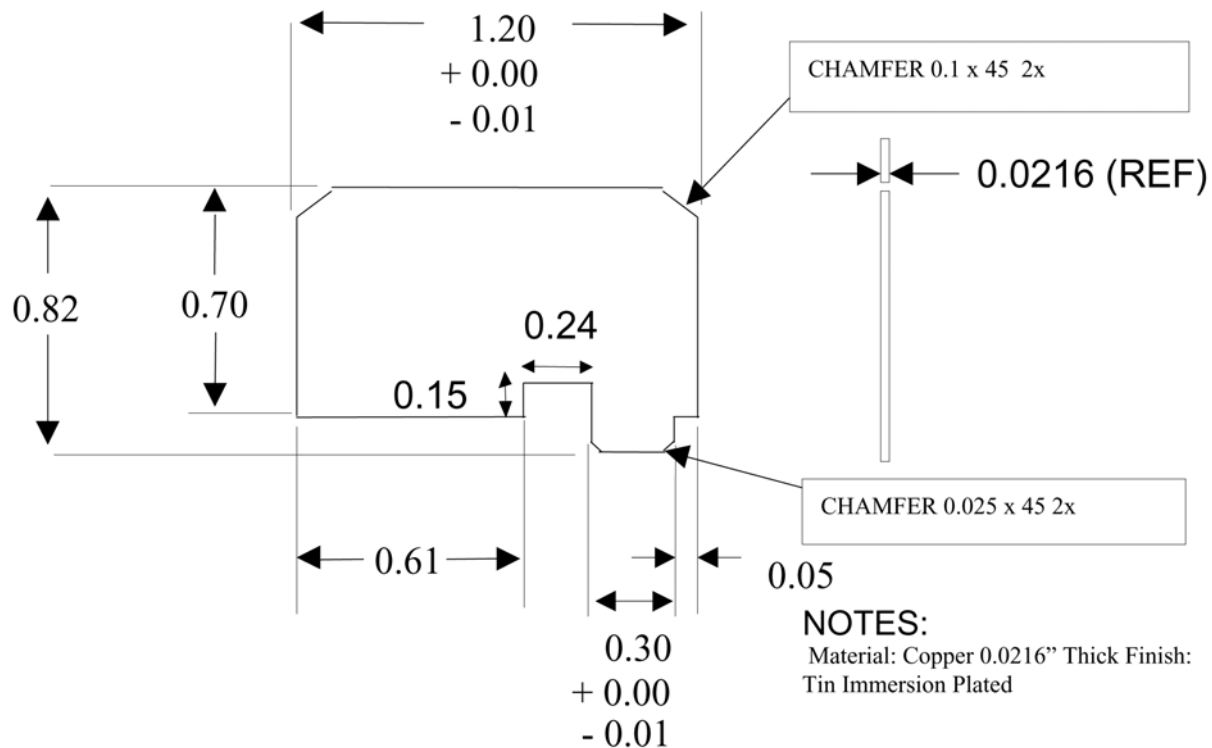

Figure 5.4 - Heat Sink.



6 Bill Of Materials

6.1 Configuration "1", 2 kV

Item	Qty.	Ref.	Description	Manufacturer	Part Number
1	2	C1, C2	6.8 μ F, 400 V, 105 °C	Rubycon	400BXA6R8M10x16
2	1	C3	0.1 μ F, 50 V, ceramic	Panasonic	ECU-S1H104KBB
3	1	C4	2.2 nF, Y1-Safety	Panasonic	ECK-DNA222ME
4	1	C5	180 μ F, 35 V (0.12 Ω)	Panasonic	EEUFC1V181
5	1	C6	82 μ F, 35 V	Panasonic	ECA-1VFK820
6	1	C7	100 μ F, 10 V	Panasonic	ECA-1AFQ101
7	4	D1- D4	Glass Passivated Diode	Vishay/ Lite On	1N4005GP
8	1	D5	600 V, 1 A, 150 ns	Fagor/Gen. Semi.	1N4937
9	1	D6	60 V, 1.1 A, Schottky	IR	11DQ6
10	1	D7	200 V, 1 A, ultrafast	ON/NTE	MUR120/NTE587
11	2	**J1,J2	Header, 3 pos., 0.156 spacing	Molex	26-48-1035
12	2	*LED1,LED2	low current	Siemens/HP	LG3369/HLMP1790
13	1	L1	2.2 mH \pm 5%, 10.9 Ω , 128 mA	Bosung	
14	1	L2	18 μ H, 10%, 2.2 A	Toko	R622LY-180k
15	1	R1	33 Ω , flame proof, fusible, 3 W	Vitrohm (Farnell Components)	(08 WX7860)
16	1	R2	4.7 k Ω , 1/8 W	Yageo	
17	1	R3	100 Ω , 1/8 W	Yageo	
18	1	R4	1 k Ω , 1/8 W	Yageo	
19	1	*R5	6.8 k Ω , 1/4 W	Yageo	
20	1	*R6	2.4 k Ω , 1/4 W	Yageo	
21	1	T1	Transformer EE16 Custom	DT Magnetics	TBD
22	1	U1	Off-line Switcher	Power Integrations	TNY266P
23	1	U2	Optocoupler	Sharp	PC817A
24	1	VR1	200 V Transient suppressor	General Instrument	BZY97C200
25	1	VR2	Zener, 4.3 V \pm 2%	Diodes Incorporated	1N5991C

*Optional

**Remove middle pin for J1

6.2 Configuration "2", 6 kV

(Add the following items to Configuration "1")

Item	Qty.	Ref.	Description	Manufacturer	Part Number
26	1	F1	0.5 A, 250 V, fast-acting fuse	Littelfuse	Series 263
27	2	R7, R8	47 Ω , 1 W	Ohmite	OX470K
28	1	RV1	Varistor, 275 V _{AC} , 14 mm	Harris/Littelfuse	V275LA20A



7 Transformer – T1

7.1 Transformer Drawing

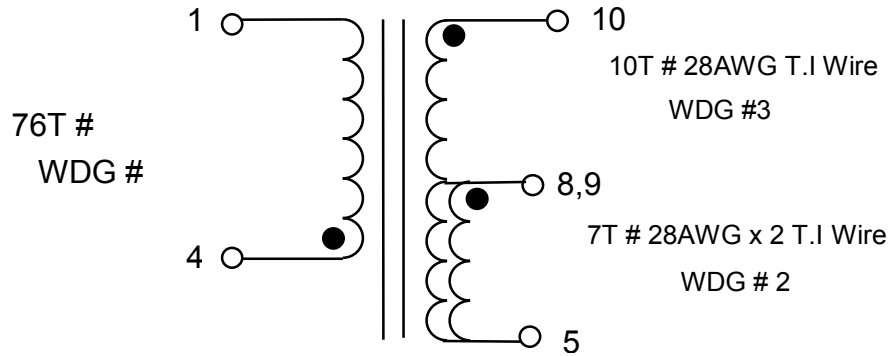

7.2 Electrical Specifications

Electrical Strength	60 Hz 1 minute, from Pins 1-4 to Pins 5-10	3000 V _{AC}
Creepage	Between Pins 1-4	6.4 mm (Min.)
Primary Inductance	All windings open	978 μH ±10%
Resonant Frequency	All windings open	1.0 MHz (Min.)

7.3 Transformer Construction

Pin Side

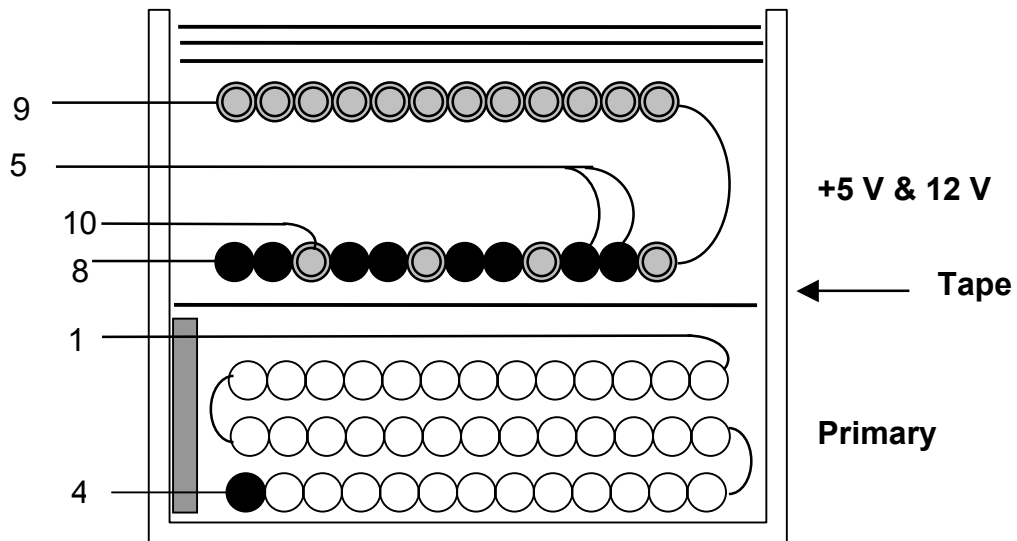

7.4 Transformer Materials

Item	Description
[1]	Core: PC40 EE16, (YING CHIN YC1607) gapped for $Alg=168 \text{ nH/T}^2$
[2]	Bobbin: BE-16 (NICERA FEE16)
[3]	Magnet Wire: # 34 AWG Heavy Nyleze
[4]	Triple Insulated Wire: # 28 AWG
[5]	Tape: 3M #10 Reinforced Epoxy Film (Cream) 1.5 mm wide by 5 mils thick
[6]	Tape: 3M 1298 Polyester Film (white) 8.2 mm wide by 2.2 mils thick

7.5 Transformer Winding Instructions

Primary Margins	Tape Margins with item [5] on one side at pins. Match height with Primary windings
Primary Layer	Start at Pin 4. Wind 26 turns of item [3] from left to right. Wind 25 turns of item [3] from right to left. Then wind the remaining 25 turns in the next layer from left to right. Finish on Pin 1.
Basic Insulation	1 Layer of tape [6] for basic insulation.
+5 V and +12 V Interleaved Winding	Start +5 V winding at Pin 8 (2 wires) of item [4] and +12 V winding at Pin 10 (1 wire) of item [4]. Wind together (3 wires) 7 turns of item [4] from right to left. Wind uniformly, in a single layer, across entire width of bobbin. Finish 5 V winding on Pin 5. Continue +12 V winding with 10 more turns, from left to right and finish at pin 9.
Basic Insulation	3 Layer of tape [6] for basic insulation.
Final Assembly	Assemble and secure core halves. Impregnate uniformly [7].



7.6 Transformer Bobbin Dimensions

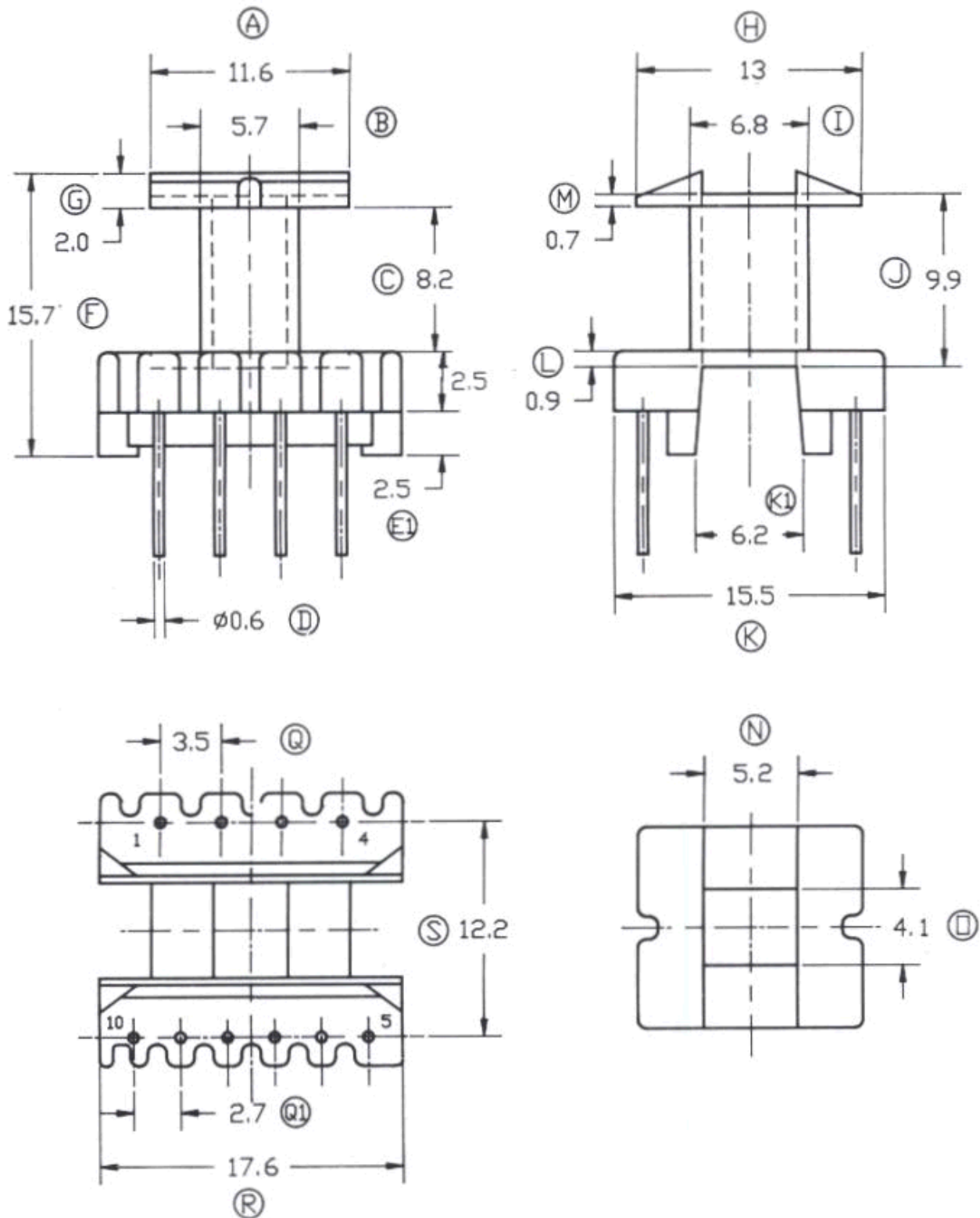

7.7 Transformer Spreadsheet

Design Warning

Power Supply Input

VACMIN	Volts	85			Minimum AC Input Voltage
VACMAX	Volts	265			Maximum AC Input Voltage
FL	Hertz	50			AC Main Frequency
TC	mSeconds	2.48			Bridge Rectifier Conduction Time Estimate
Z		0.61			Loss Allocation Factor
N	%	71.0			Efficiency Estimate

Power Supply Outputs

VOx	Volts		5.00	12.00	Output Voltage
IOx	Amps		0.500	0.208	Power Supply Output Current

Device Variables

Device		TNY266			Device Name
PO	Watts	5.00			Total Output Power
VDRAIN	Volts	521			Maximum Drain Voltage Estimate (Includes Effect of Leakage Inductance)
VDS	Volts	4.7			Device On-State Drain to Source Voltage
FSnom	Hertz	132000			TinySwitch-II Switching Frequency
FSmin	Hertz	120000			TinySwitch-II Minimum Switching Frequency (inc. Jitter)
FSmax	Hertz	144000			TinySwitch-II Maximum Switching Frequency (inc. Jitter)
KRPKDP		0.79			Ripple to Peak Current Ratio
ILIMITMIN	Amps	0.33			Device Current Limit, Minimum
ILIMITMAX	Amps	0.38			Device Current Limit, Maximum
IRMS	Amps	0.15			Primary RMS Current
DMAX		0.44			Maximum Duty Cycle

Power Supply Components Selection

CIN	uFarads	13.6			Input Filter Capacitor
VMIN	Volts	82			Minimum DC Input Voltage
VMAX	Volts	375			Maximum DC Input Voltage
VCLO	Volts	130			Clamp Zener Voltage
PZ	W	0.3			Estimated Primary Zener Clamp Loss

Power Supply Output Parameters

VDx	Volts		0.5	0.7	Output Winding Diode Forward Voltage Drop
PIVSx	Volts		39	91	Output Rectifier Maximum Peak Inverse Voltage
ISPx	Amps		1.78	0.74	Peak Secondary Current
ISRMSx	Amps		0.86	0.36	Secondary RMS Current
IRIPPLEx	Amps		0.70	0.29	Output Capacitor RMS Ripple Current



Transformer Construction Parameters

Core/Bobbin		EE16			Core and Bobbin Type
Core Manuf.		Generic			Core Manufacturing
Bobbin Manuf.		Generic			Bobbin Manufacturing
LPmin	uHenries	978			Minimum Primary Inductance
NP		76			Primary Winding Number of Turns
AWG	AWG	30			Primary Wire Gauge (Rounded to next smaller standard AWG value)
CMA	Cmils/A	696			Primary Winding Current Capacity (200 < CMA < 500). Warning! Primary circular mils per amp (CMA) is too high. Decrease transformer size, decrease L, increase NS, decrease VACmin, increase VOR, increase KrpKdp.
VOR	Volts	60.00			Reflected Output Voltage
BW	mm	8.50			Bobbin Physical Winding Width
M	mm	0.0			Safety Margin Width
L		3.0			Number of Primary Layers
AE	cm ²	0.19			Core Effective Cross Section Area
ALG	nH/T ²	168			Gapped Core Effective Inductance
BM	Gauss	2611			Maximum Operating Flux Density
BAC	Gauss	900			AC Flux Density
LG	mm	0.12			Gap Length (Lg > 0.051 for TOP22X, Lg > 0.1 for TOP23X)
LL	uH	19.6			Estimated Transformer Primary Leakage Inductance
LSEC	nH	20			Estimated Secondary Trace Inductance

Secondary Parameters

NSx			7.00	16.16	Secondary Number of Turns
Rounded Down NSx				16	Rounded to Integer Secondary Number of Turns
Rounded Down Vox	Volts			11.87	Auxiliary Output Voltage for Rounded to Integer NSx
Rounded Up NSx				17	Rounded to Next Integer Secondary Number of Turns
Rounded Up Vox	Volts			12.66	Auxiliary Output Voltage for Rounded to Next Integer NSx
AWGSx Range	AWG		24 - 28	28 - 32	Secondary Wire Gauge Range (CMA range 500 - 200). Wire gauge (AWG) is less than 26 AWG. Consider parallel winding (see AN-18, AN-22).



8 Performance Data

TEST EQUIPMENT

INPUT: VOLTECH (PM1000) AC POWER ANALYZER.
 OUTPUT: KIKUSUI (PLZ153W) ELECTRONIC LOAD.

8.1 Efficiency

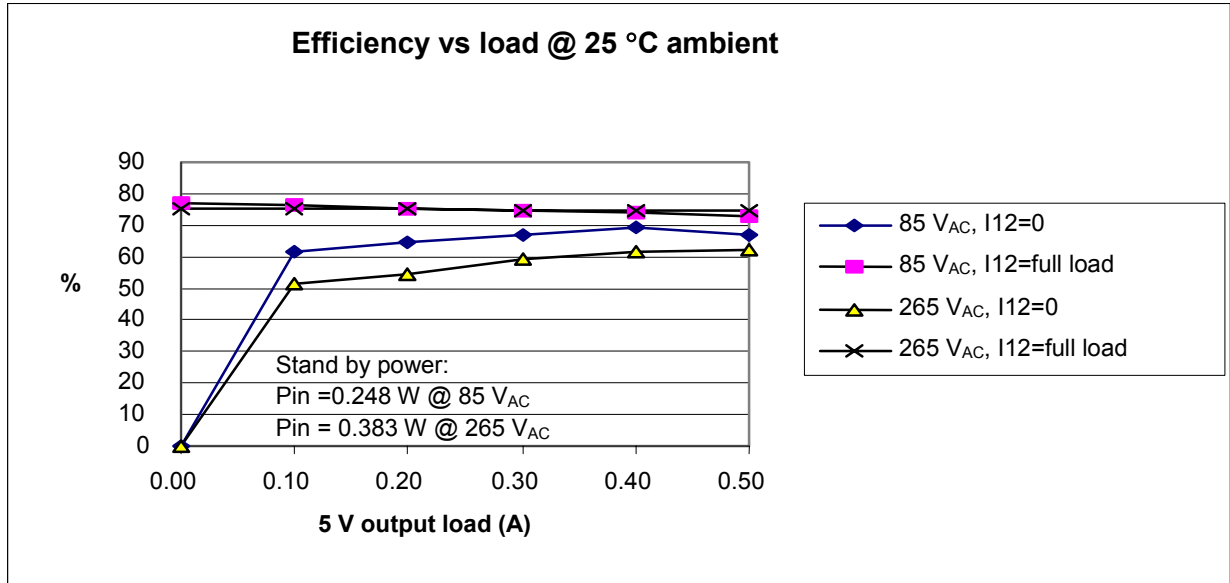

Figure 8.1.1 - Efficiency vs. Output Power @ 25 °C Ambient.

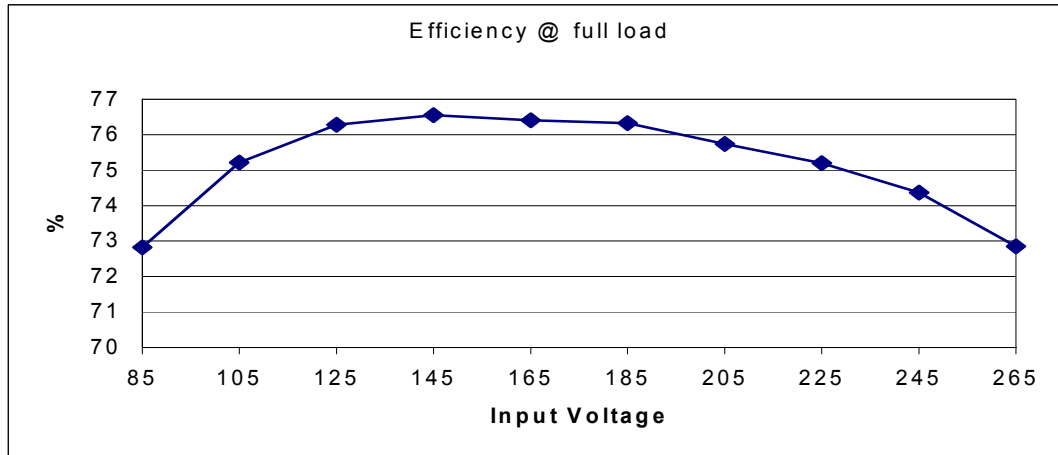

Figure 8.1.2 - Efficiency vs. Line Voltage @ 25 °C Ambient.



8.2 Regulation @ 25 °C Ambient

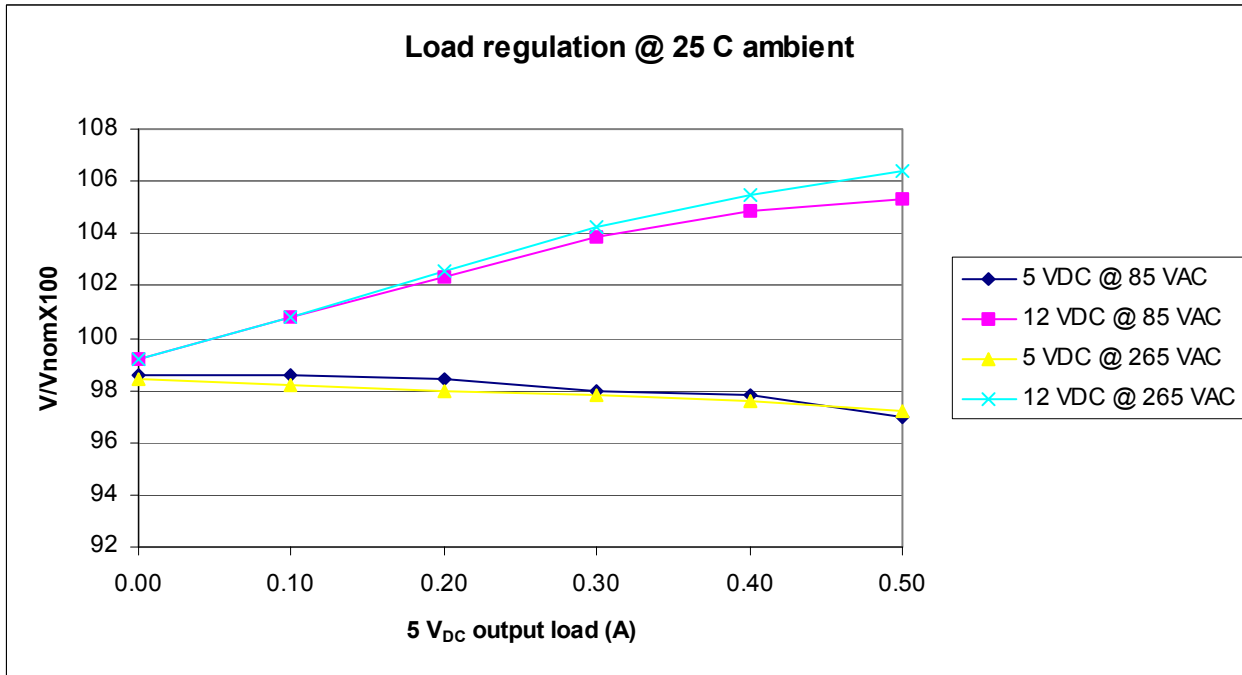

Figure 8.2.1 - Line Regulation @ Full Load, 25° C Ambient.

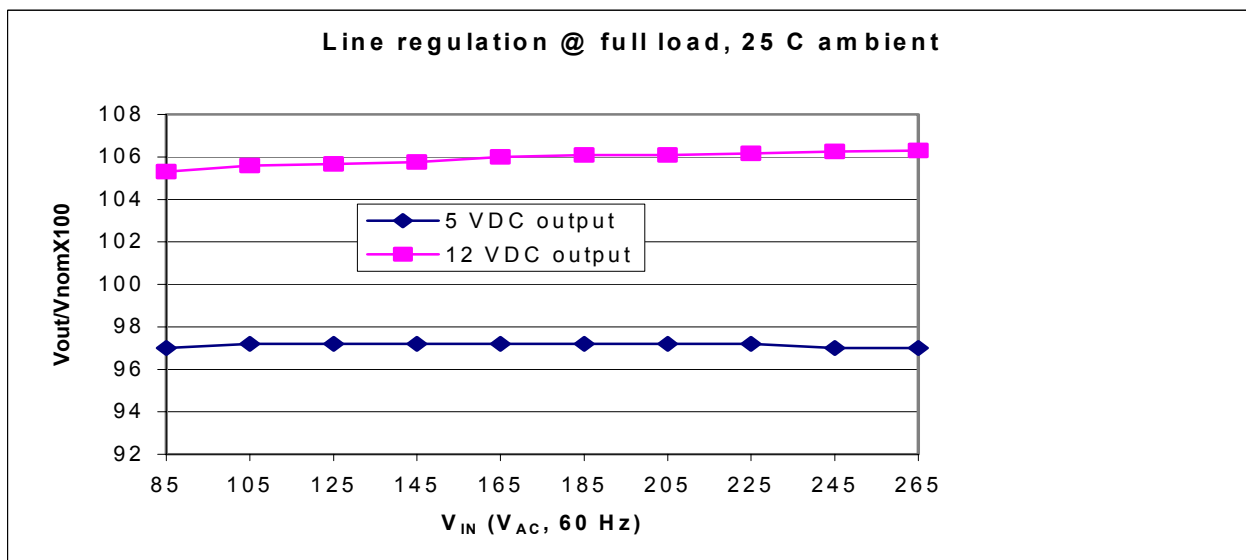

Figure 8.2.2 - Load Regulation @ 25° C Ambient



8.3 Temperature

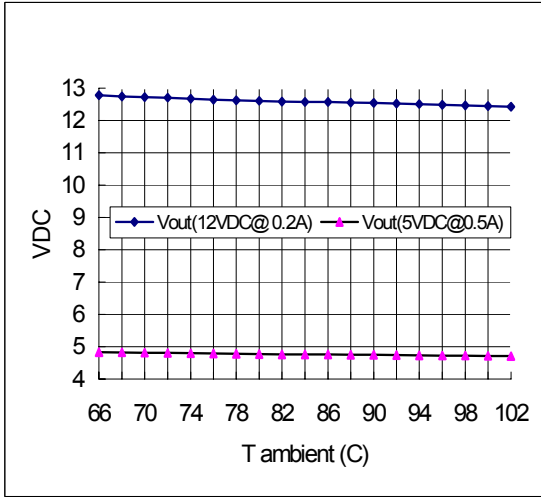

Figure 8.3.1 - V_{OUT} vs. Ambient Temperature.

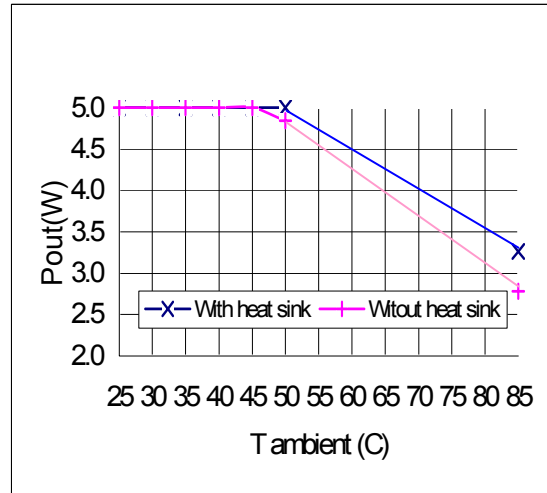

Figure 3.3.2 - Max Power.

(Source Pin Temperature ≤110 °C.)



8.4 Waveforms (2 kV config. "1")

8.4.1 Turn-on Delay/Hold-up Time

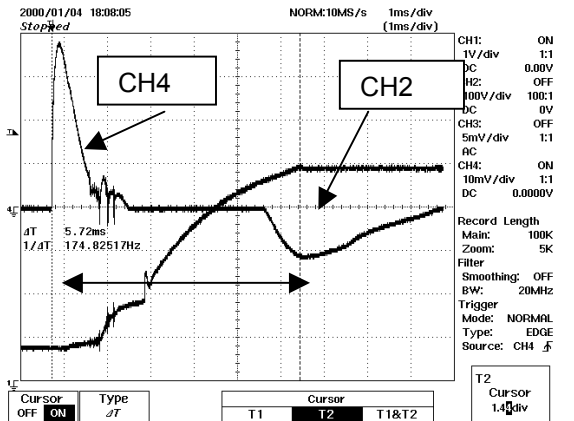

Figure 8.4.1.1 – Turn-on Delay – First Current Pulse. CH4: I_{IN_MAINS} (0.5 A/div), CH2: V_{OUT} (1 V/div).

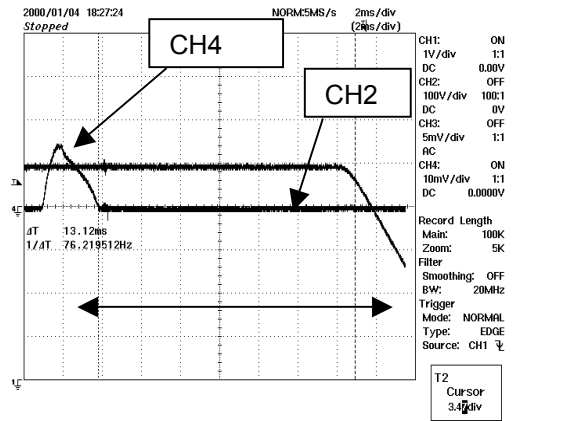

Figure 8.4.1.2 – Hold-up Time – Last Current Pulse. CH4: I_{IN_MAINS} (0.2 A/div), CH2: V_{OUT} (1 V/div).

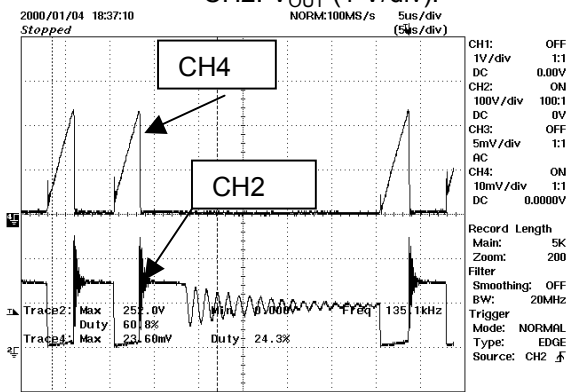

Figure 8.4.2.1 - I_D and V_{DS} @ $V_{IN}=85V_{AC}$. CH4: I_D (0.2 A/div), CH2: V_{DS} (100V/div)

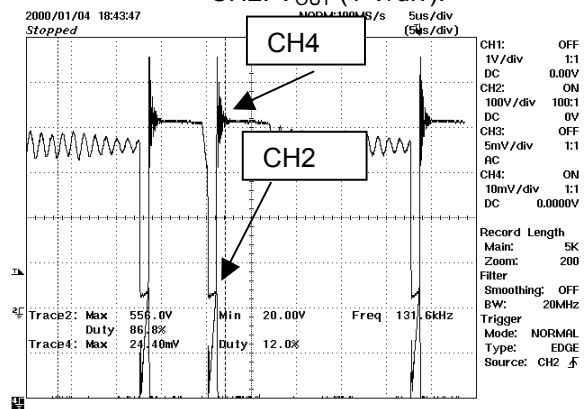

Figure 8.4.2.2 - I_D and V_{DS} @ $V_{IN}=265V_{AC}$. CH4: I_D (0.2 A/div), CH2: V_{DS} 100 V/div)



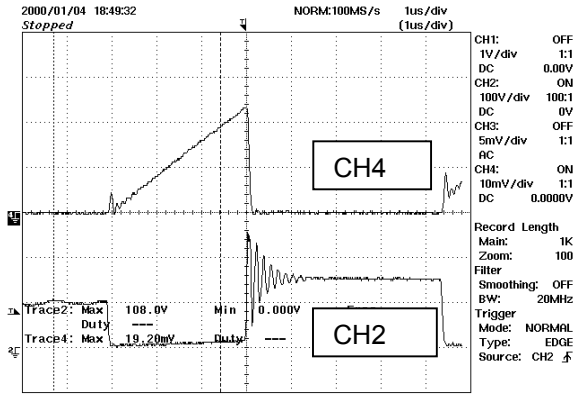

Figure 8.4.2.3 - I_D and V_{DS} @ 85 V_{AC} .
CH4: I_D (0.2 A/div),
CH2: V_{DS} (100 V/div)

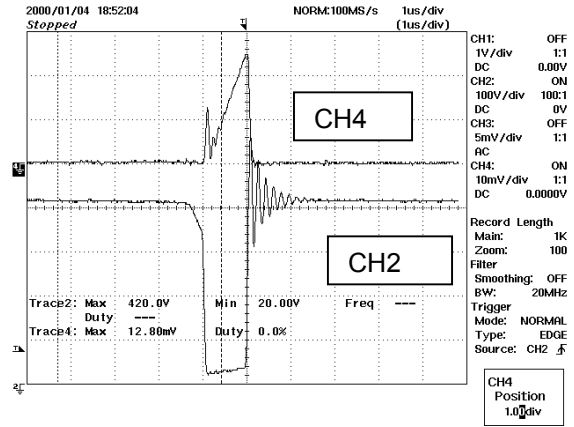

Figure 8.4.2.4 - I_D and V_{DS} @ 265 V_{AC} .
CH4: I_D (0.2 A/div),
CH2: V_{DS} (100 V/div)

8.4.2 Auto-Restart

Maximum load, before power limiting (entering auto-restart) @ 25 °C

V_{IN} (V_{AC} , 60 Hz)	Load condition	5 V_{DC} output	12 V_{DC} output	Total output (W)
85	1	1.09 A @ 4.74 V	0.2 A @ 13.04 V	7.8
85	2	0.5 A @ 4.89 V	0.45 A @ 12.46 V	8.05

Load condition 1: 5 V output overloaded; 12 V_{OUT} full load.

Load condition 2: 12 V output overloaded; 5 V_{OUT} full load.

Because of higher efficiency on the 12 V output, the maximum power output occurs when the 12 V output is overloaded.

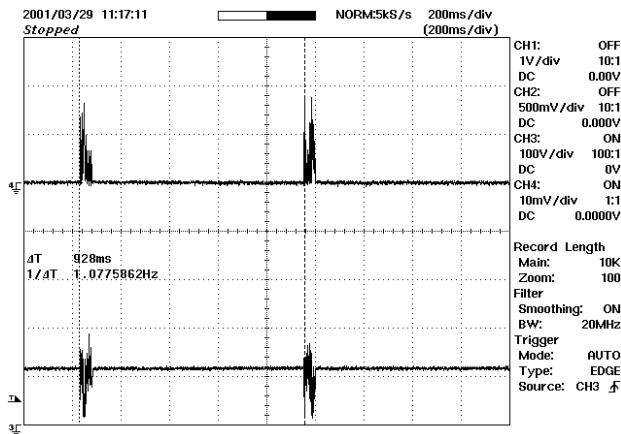

Figure 8.4.3 – Auto restart @ 85 V_{AC} .
CH4: I_D (0.2 A/div),
CH3: V_{DS} (100 V/div)



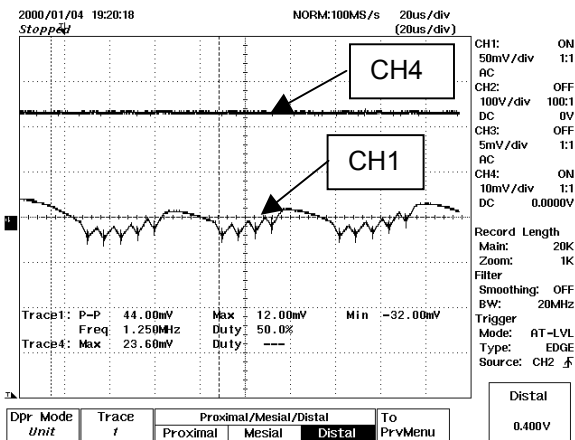

Figure 8.4.4.1 - Output Voltage Ripple at Full Load
5 V_{DC} at 85 V_{AC}.
CH4: I_{OUT} (0.2 A/div),
CH1: V_{OUT} (50 mV/div)

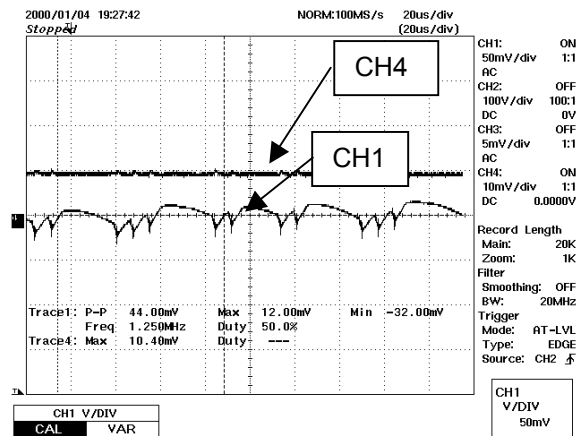

Figure 8.4.4.2 - Output Voltage Ripple at Full Load
5 V_{DC} at 265 V_{AC}.
CH4: I_{OUT} (0.5 A/div),
CH1: V_{OUT} (50 mV/div)

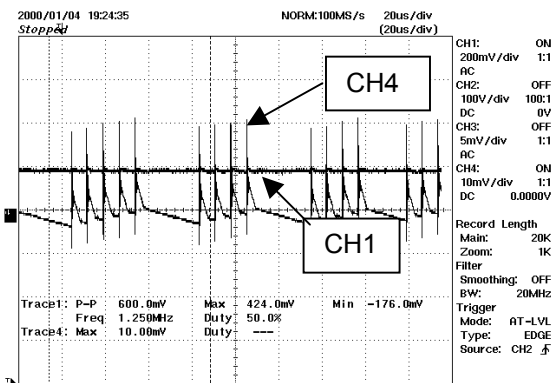

Figure 8.4.4.3 - Output Voltage Ripple at Full Load
12 V_{DC} at 85 V_{AC}.
CH4: I_{OUT} (0.2 A/div),
CH1: V_{OUT} (200 mV/div)

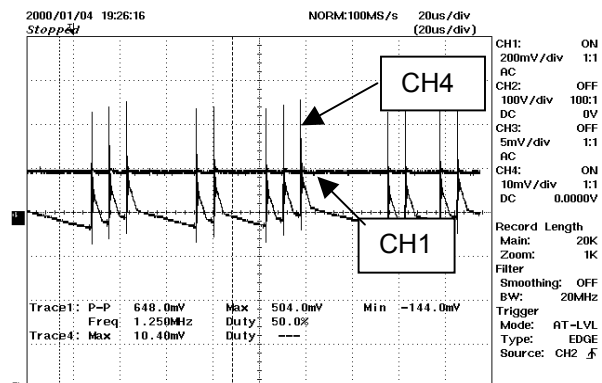

Figure 8.4.4.4 - Output Voltage Ripple at Full Load
12 V_{DC} at 265 V_{AC}.
CH4: I_{OUT} (0.2 A/div),
CH1: V_{OUT} (200 mV/div)

8.5 Transient Response

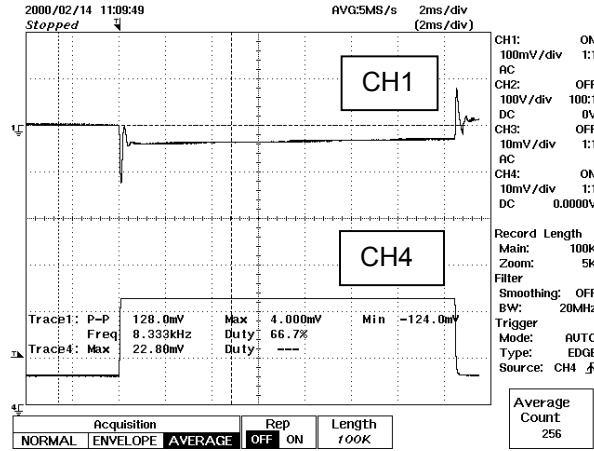

Figure 8.5.1 - Transient Response – 5 V Output
 @ $V_{IN} = 115 V_{AC}$ 20-80%
 Load Change.
 CH4: I_{OUT} (0.2 A/div),
 CH1: V_{OUT} (100 mV/div)

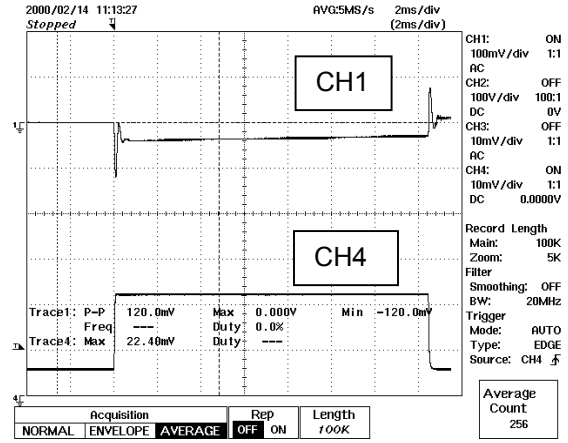

Figure 8.5.2 - Transient Response – 5 V Output
 @ $V_{IN} = 230 V_{AC}$ 20-80%
 Load Change.
 CH4: I_{OUT} (0.2 A/Div).
 CH1: V_{OUT} (100 mV/Div)

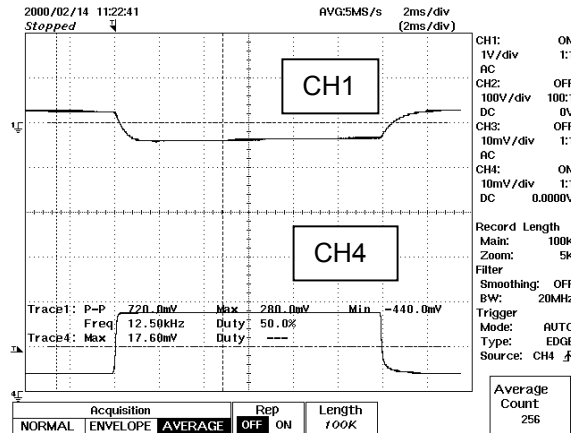

Figure 8.5.3 - Transient Response – 5 V Output
 @ $V_{IN} = 115 V_{AC}$ 20-80%
 Load Change.
 CH4: I_{OUT} (0.1 A/div),
 CH1: V_{OUT} (1 V/div)

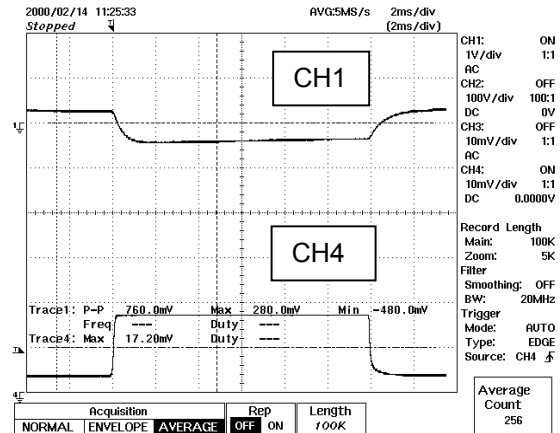

Figure 8.5.4 - Transient Response – 5 V Output
 @ $V_{IN} = 230$ 20-80%
 Load Change.
 CH4: I_{OUT} (0.1 A/Div),
 CH1: V_{OUT} (1 V/Div)



8.6 Conducted EMI Scans

The attached plots show worst-case EMI performance for EP8 as compared to CISPR22B conducted emissions limits. Peak detection is commonly used for initial diagnosis of EMI, as full frequency range results can be quickly obtained, using a common spectrum analyzer. This is also a worst-case form of analysis, as the CISPR22B limits are based on quasi-peak and average detection, both of which give lower amplitude results than peak detection.

For EMI and safety techniques refer to PI application note AN15 (Figure 6 shows a typical test set up).

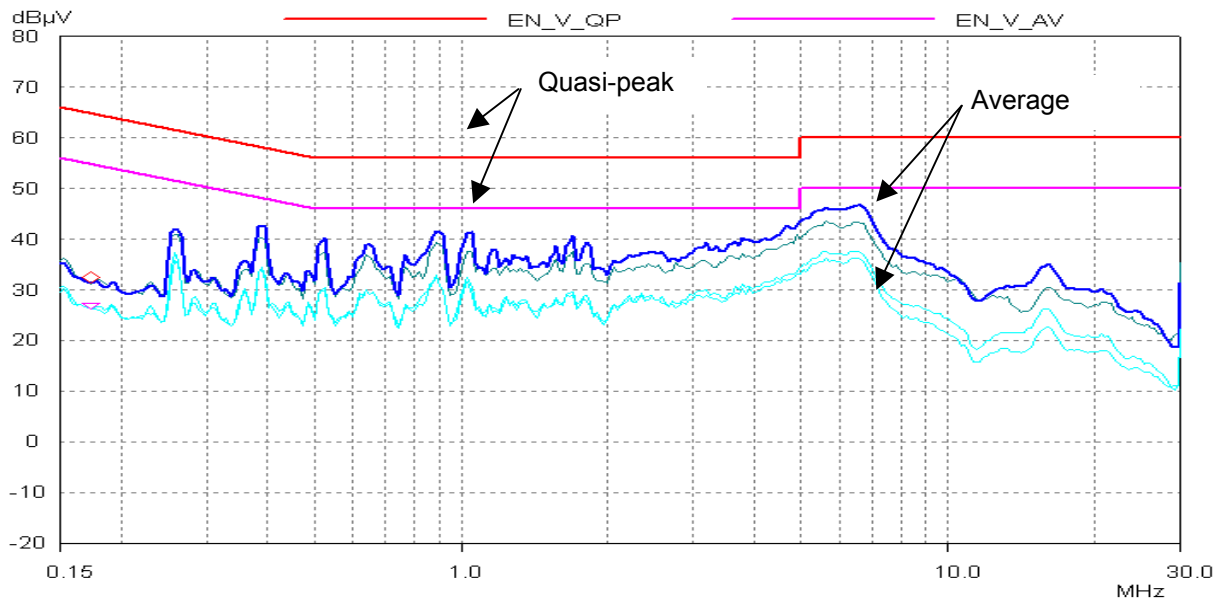

Figure 8.6.1 - EP9, TNY266, L, N, 120 V_{AC}, Full Load, CISPR Limits.

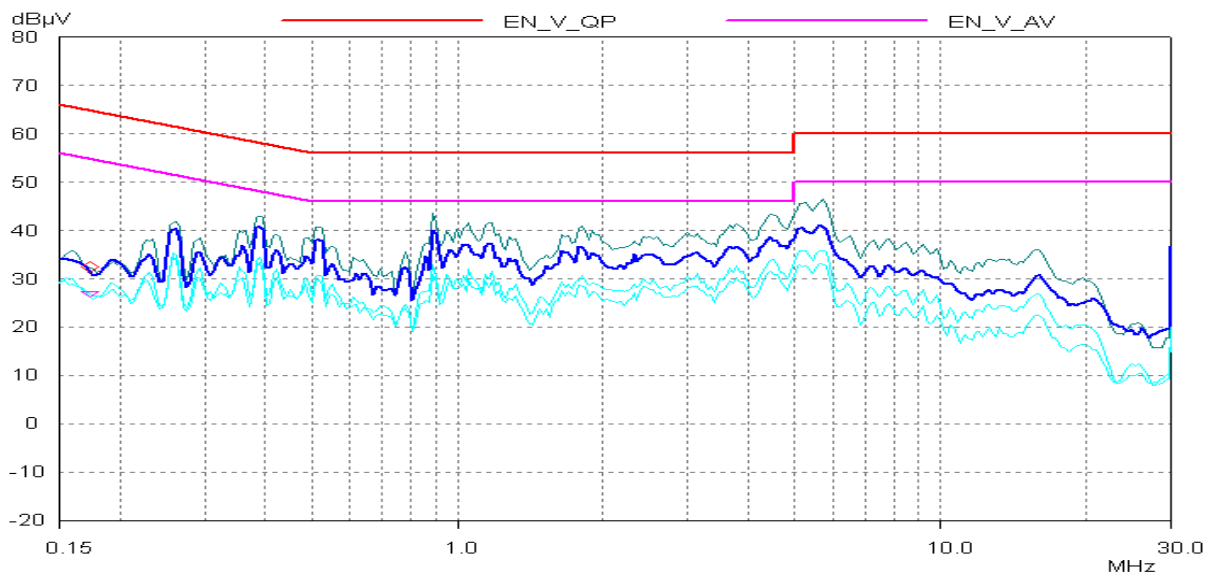

Figure 8.6.2 - EP9, TNY266, L, N, 230 V_{AC}, Full Load, CISPR Limits.

8.7 Surge Voltage Immunity (2 kV and 6 kV, 1.2/50 μ s per IEC1000-4-5)

The surge protection for configuration "1" (2 kV) and configuration "2" (6 kV) is illustrated in the schematics (pages 4 and 5).

R7, R8 limit the maximum surge current to approximately 50 A, the value at which the clamping voltage of the varistor is characterized (< 800 V). This voltage level was selected to ensure enough margin for the diode bridge D1-D4. The 6 kV, 1.2/50 μ s pulse at 800 V clipping level is approximately 100 μ s (see Fig. 8.7.2). From the graph in Fig.8.7.1 it can be inferred that the unit will survive 10 k surges of 6 kV. Reducing the value of R7, R8 would reduce the total number of 6 kV pulses the unit can survive.

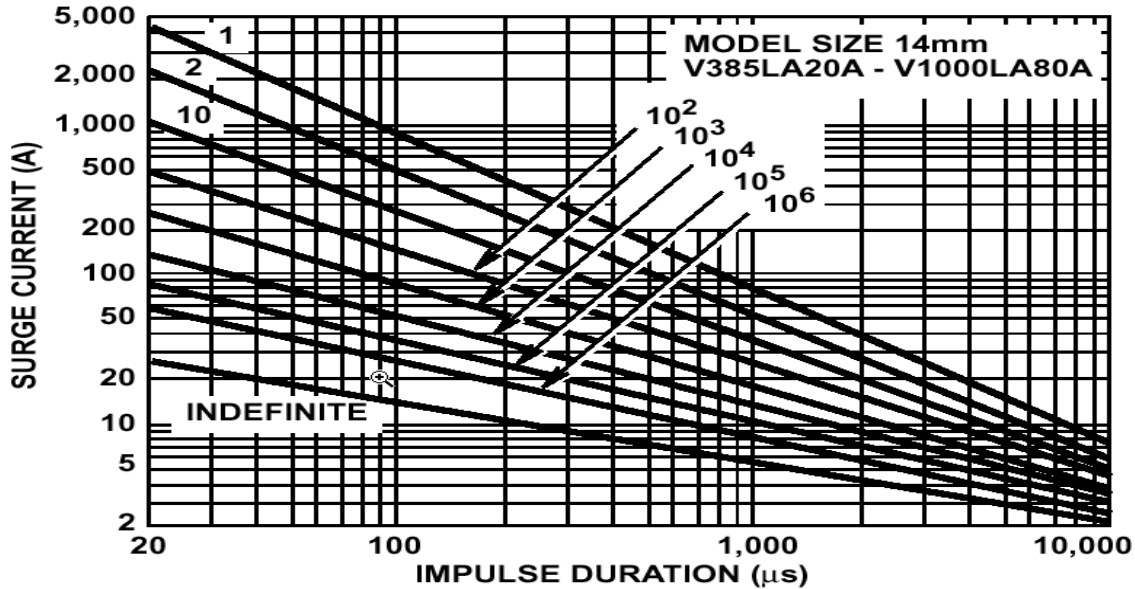

Figure 8.7.1 - Varistor Life (Number of Surges) as a Function of the Rectangular Pulse Amplitude and its Duration.

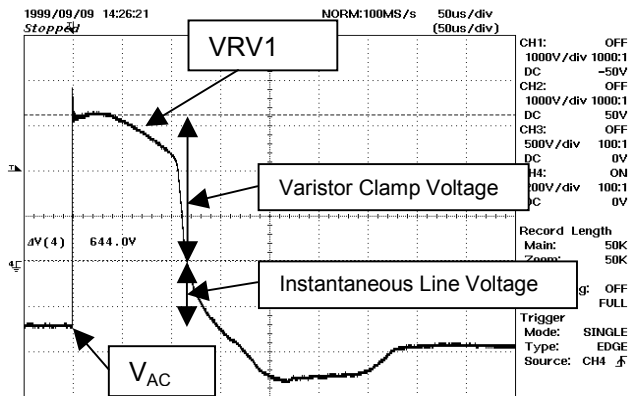

Figure 8.7.2 - Varistor Clamping Voltage.



8.8 Acoustic Emissions

The power supply was subjected to acoustic emissions measurement. The worst-case noise was measured for variations of both AC line and output loading conditions and is presented in Figure 8.8.1.

The test unit was placed in an anechoic acoustic chamber, with a microphone located approximately 1” (25 mm) above the transformer (T1). The power supply was oriented in a horizontal position with the power supply output loaded via an external Kikusui electronic load. The microphone output was fed to an Audio Precision audio analyzer to provide the measurements shown. The curves shown indicate the spectral content of the noise generated by the supply once the ANSI-A weighting factor has been applied.

The audio limit line (Figure 8.8.1) visible at +35 dB represents the generally accepted threshold for power supply audio noise. A discrete audio frequency amplitude was used rather than a dBA value (dBA represents the whole audio spectrum). Large peaks may not raise the dBA value yet can result in unacceptable perceived noise.

As a reference, the approximate dBA background noise floor level is 30 dBA. The microphone sensitivity is such that 20 μP = 0 dB SPL.

Up to a further 20 dB reduction can be expected from the measurement shown, once the power supply is sealed inside an enclosure.

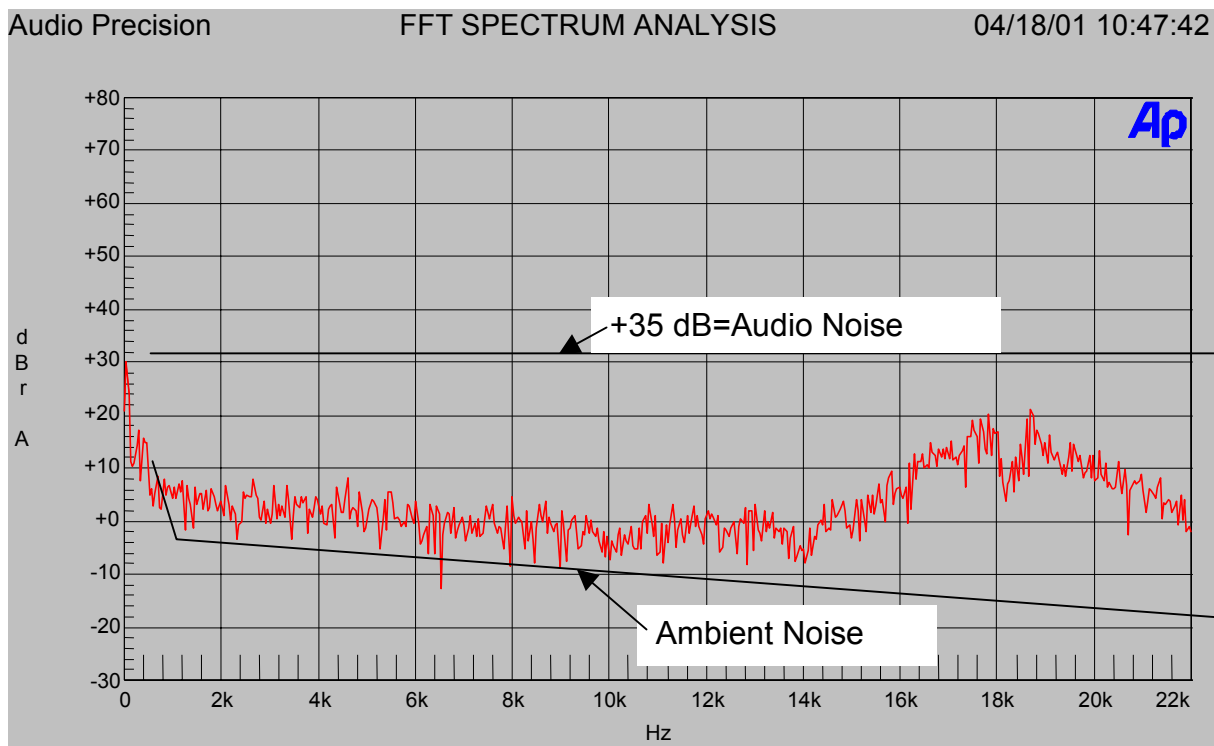

Figure 8.8.1 - Worst Case Audio Level, 120 V_{AC} Input, Full Load.



Appendix A1.2 Bill of Materials (5 W, 5 V_{DC}, 24 V_{DC} PS)**Configuration "2", 6 kV**

Item	Qty.	Ref.	Description	Manufacturer	Part Number
1	2	C1, C2	6.8 μ F, 400 V, 105 °C	Rubycon	400BXA6R8M10 x16
2	1	C3	0.1 μ F, 50 V, ceramic		
3	1	C4	2.2 nF, Y1-Safety	Panasonic	ECK-DNA222ME
4	1	C5	180 μ F, 35 V (0.12 Ω)	Panasonic	
5	1	C6	82 μ F, 35 V	Panasonic	
6	1	C7	100 μ F, 10 V	Panasonic	
7					
8	4	D1- D4	Glass Passivated Diode		1N4005GP
9	1	D5	600 V, 1 A, 150 ns	Fagor	1N4937
10	1	D6	60 V, 1.1 A, Schottky	ON	11DQ6
11	1	D7	400 V, 1 A, ultrafast	ON	MUR140
12	1	F1	0.5 A, 250 V, fast-acting fuse	Littelfuse	Series 263
13	2	**J1,J2	Header, 3 pos.,0.156 spacing		
14	2	*LED1,LED2	low current	Siemens	LG3369
15	1	L1	2.2 mH \pm 5%, 10.9 Ω , 128 mA	Bosung	
16	1	L2	18 μ H, 10%, 2.2 A	Toko	622LY-180k
17	1	R2	4.7 k Ω , 1/8 W		
18	1	R3	100 Ω , 1/8 W		
19	1	R4	1 k Ω , 1/8 W		
20	1	*R5	13 k Ω , 1/4 W		
21	1	*R6	2.4 k Ω , 1/4 W		
22	2	R7, R8	47 Ω , 1 W	Ohmite	OX470K
23	1	T1	Transformer	EE16 Custom	
24	1	U1	Off-line Switcher	Power Integrations	TNY266P
25	1	U2	Optocoupler		PC817A
26	1	VR1	200 V Transient suppressor		BZY-97C200
27	1	VR2	Zener, 4.3 V \pm 2%		1N5991C
28	1	RV1	Varistor, 275 V _{AC} , 14 mm	Harris/Littelfuse	V275LA20A

*Optional

**Remove middle pin for J1



Appendix A1.3 Transformer Spreadsheet

Design Warning

Power Supply Input

VACMIN	Volts	85			Minimum AC Input Voltage
VACMAX	Volts	265			Maximum AC Input Voltage
FL	Hertz	50			AC Main Frequency
TC	mSeconds	2.46			Bridge Rectifier Conduction Time Estimate
Z		0.61			Loss Allocation Factor
N	%	72.0			Efficiency Estimate

Power Supply Outputs

VOx	Volts		5.00	24.00	Output Voltage
IOx	Amps		0.500	0.104	Power Supply Output Current

Device Variables

Device		TNY266			Device Name
PO	Watts	5.00			Total Output Power
VDRAIN	Volts	521			Maximum Drain Voltage Estimate (Includes Effect of Leakage Inductance)
VDS	Volts	4.5			Device On-State Drain to Source Voltage
FSnom	Hertz	132000			TinySwitch-II Switching Frequency
FSmin	Hertz	120000			TinySwitch-II Minimum Switching Frequency (inc. Jitter)
FSmax	Hertz	144000			TinySwitch-II Maximum Switching Frequency (inc. Jitter)
KRPKDP		0.83			Ripple to Peak Current Ratio
ILIMITMIN	Amps	0.33			Device Current Limit, Minimum
ILIMITMAX	Amps	0.38			Device Current Limit, Maximum
IRMS	Amps	0.14			Primary RMS Current
DMAX		0.42			Maximum Duty Cycle

Power Supply Components Selection

CIN	uFarads	15.0			Input Filter Capacitor
VMIN	Volts	86			Minimum DC Input Voltage
VMAX	Volts	375			Maximum DC Input Voltage
VCLO	Volts	130			Clamp Zener Voltage
PZ	W	0.3			Estimated Primary Zener Clamp Loss

Power Supply Output Parameters

VDx	Volts		0.5	1.0	Output Winding Diode Forward Voltage Drop
PIVSx	Volts		39	180	Output Rectifier Maximum Peak Inverse Voltage
ISPx	Amps		1.78	0.37	Peak Secondary Current
ISRMSx	Amps		0.86	0.18	Secondary RMS Current
IRIPPLEx	Amps		0.69	0.14	Output Capacitor RMS Ripple Current



Transformer Construction Parameters

Core/Bobbin		EE16			Core and Bobbin Type
Core Manuf.		Generic			Core Manufacturing
Bobbin Manuf.		Generic			Bobbin Manufacturing
LPmin	uHenries	954			Minimum Primary Inductance
NP		76			Primary Winding Number of Turns
AWG	AWG	30			Primary Wire Gauge (Rounded to next smaller standard AWG value)
CMA	Cmils/A	722			Primary Winding Current Capacity (200 < CMA < 500). Warning! Primary circular mils per amp (CMA) is too high. Decrease transformer size, decrease L, increase NS, decrease VACmin, increase VOR, increase KrpKdp.
VOR	Volts	60.00			Reflected Output Voltage
BW	mm	8.50			Bobbin Physical Winding Width
M	mm	0.0			Safety Margin Width
L		3.0			Number of Primary Layers
AE	cm ²	0.19			Core Effective Cross Section Area
ALG	nH/T ²	164			Gapped Core Effective Inductance
BM	Gauss	2553			Maximum Operating Flux Density
BAC	Gauss	924			AC Flux Density
LG	mm	0.13			Gap Length (Lg > 0.051 for TOP22X, Lg > 0.1 for TOP23X)
LL	uH	19.1			Estimated Transformer Primary Leakage Inductance
LSEC	nH	20			Estimated Secondary Trace Inductance

Secondary Parameters

NSx			7.00	31.82	Secondary Number of Turns
Rounded Down NSx				31	Rounded to Integer Secondary Number of Turns
Rounded Down Vox	Volts			23.36	Auxiliary Output Voltage for Rounded to Integer NSx
Rounded Up NSx				32	Rounded to Next Integer Secondary Number of Turns
Rounded Up Vox	Volts			24.14	Auxiliary Output Voltage for Rounded to Next Integer NSx
AWGSx Range	AWG		24 - 28	31 - 35	Secondary Wire Gauge Range (CMA range 500 - 200). Wire gauge (AWG) is less than 26 AWG. Consider parallel winding (see AN-18, AN-22).



Revision History

Date	Author	Rev	Description
8.16.99	SL	1	First Draft
11.6.99	SL	2	Second Draft
2.7.2000	SL	3	Third Draft
2.24.2000	SL	4	4 th Draft
3.23.2000	SL	5	Release
5.18.2000	SL	6	Revised layout, leaded C3
7.12.2000	SL	7	Revised schematic/BOM (L1, C3, C5, replaced R1=8.2 with F1)
4.3.2001	SL	8	Replaced TNY256P with TNY266P



Notes



Notes



For the latest updates, visit our website: www.powerint.com

Power Integrations reserves the right to make changes to its products at any time to improve reliability or manufacturability. Power Integrations does not assume any liability arising from the use of any device or circuit described herein, nor does it convey any license under its patent rights or the rights of others.

PI Logo, **TOPSwitch** and **TinySwitch** are registered trademarks of Power Integrations, Inc.

© Copyright 2001, Power Integrations, Inc.

**WORLD HEADQUARTERS
NORTH AMERICA - WEST**

Power Integrations, Inc.
5245 Hellyer Avenue
San Jose, CA 95138 USA.
Main: +1•408•414•9200
Customer Service:
Phone: +1•408•414•9665
Fax: +1•408•414•9765

KOREA

Power Integrations
International
Holdings, Inc.
Rm# 402, Handuk Building,
649-4 Yeoksam-Dong,
Kangnam-Gu,
Seoul, Korea
Phone: +82•2•568•7520
Fax: +82•2•568•7474

EUROPE & AFRICA

Power Integrations (Europe)
Ltd.
Centennial Court
Easthampstead Road
Bracknell
Berkshire RG12 1YQ,
United Kingdom
Phone: +44•1344•462•301
Fax: +44•1344•311•732

JAPAN

Power Integrations, K.K.
Keihin-Tatemono 1st Bldg.
12-20 Shin-Yokohama 2-
Chome,
Kohoku-ku, Yokohama-shi,
Kanagawa 222, Japan
Phone: +81•45•471•1021
Fax: +81•45•471•3717

TAIWAN

Power Integrations International
Holdings, Inc.
2F, #508, Chung Hsiao E. Rd.,
Sec. 5,
Taipei 105, Taiwan
Phone: +886•2•2727•1221
Fax: +886•2•2727•1223

INDIA (Technical Support)

Innovatech
#1, 8th Main Road
Vasanthnagar
Bangalore, India 560052
Phone: +91•80•226•6023
Fax: +91•80•228•9727

CHINA

Power Integrations International
Holdings, Inc.
Rm# 1705, Bao Hua Bldg.
1016 Hua Qiang Bei Lu
Shenzhen Guangdong, 518031
Phone: +86•755•367•5143
Fax: +86•755•377•9610

APPLICATIONS HOTLINE

World Wide +1•408•414•9660

APPLICATIONS FAX

World Wide +1•408•414•9760



Power Integrations, Inc.

Tel: +1 408 414 9200 Fax: +1 408 414 9201
www.powerint.com