

EMI FILTER/TVS ARRAY

APPLICATIONS

- ✓ Cellular Phones
- ✓ Notebooks
- ✓ Personal Digital Assistant (PDA)
- ✓ Ground Positioning System (GPS)
- ✓ SMART Cards

IEC COMPATIBILITY (EN61000-4)

- ✓ 61000-4-2 (ESD): Air - 15kV, Contact - 8kV
- ✓ 61000-4-4 (EFT): 40A - 5/50ns

FEATURES

- ✓ ESD Protection > 25 kilovolts
- ✓ Bidirectional EMI Filtering/TVS Low Pass Filters
- ✓ Low Insertion Loss: -3db Roll-Off @ 90MHz
- ✓ Protects Up to Four(4) Data Lines
- ✓ RoHS Compliant on Lead-Free Versions

MECHANICAL CHARACTERISTICS

- ✓ 10 Bump Flip Chip Package
- ✓ Weight 0.73 milligrams (Approximate)
- ✓ Available in Tin-Lead or Lead-Free Plating
- ✓ Solder Reflow Temperature:
 - Tin-Lead - Sn/Pb, 85/15: 240-245°C
 - Lead-Free - Sn/Ag/Cu, 96/3.5/0.5: 260-270°C
- ✓ Flammability Rating UL 94V-0
- ✓ 8mm Tape and Reel Per EIA Standard 481

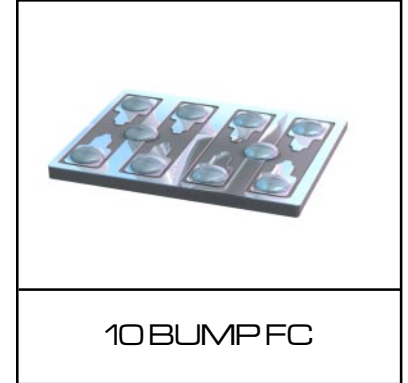

PIN CONFIGURATIONS

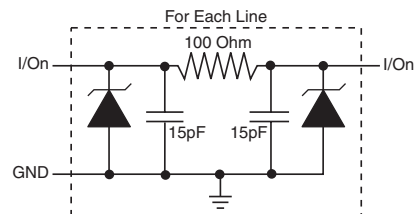
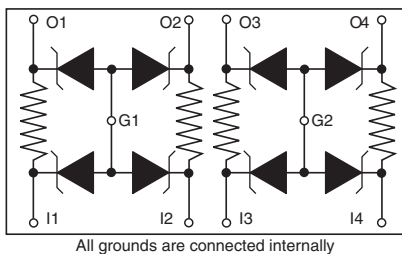

DEVICE CHARACTERISTICS

MAXIMUM RATINGS @ 25°C Unless Otherwise Specified			
PARAMETER	SYMBOL	VALUE	UNITS
Operating Temperature	T_J	-40°C to 85°C	°C
Storage Temperature	T_{STG}	-55°C to 150°C	°C
DC Power Per Resistor	P	100	mW
Typical Resistance @ ± 20%	R	100	OHMS

ELECTRICAL CHARACTERISTICS PER LINE @ 25°C Unless Otherwise Specified							
PART NUMBER	RATED STAND-OFF VOLTAGE	MINIMUM BREAKDOWN VOLTAGE	MAXIMUM REVERSE LEAKAGE CURRENT	TYPICAL FORWARD VOLTAGE	MINIMUM ATTENUATION	CUT-OFF FREQUENCY (50 Ohms I/O ZERO BIAS)	TYPICAL CAPACITANCE PER LINE (See Note 1)
	V_{WM} VOLTS	@ 1mA $V_{(BR)}$ VOLTS	@ 3V I_D μA	@ 10mA V_F VOLTS	@ 800-3000 MHz dB	f_c MHz	@ 2.5V, 1 MHz C_{Line} pF
EMIF4-100LFC	5.0	6.0	0.1	0.8	30	90	30

Note 1: ±20% tolerance.

FIGURE 1
RESISTANCE VS TEMPERATURE
(Normalized to Resistance at 25°C)

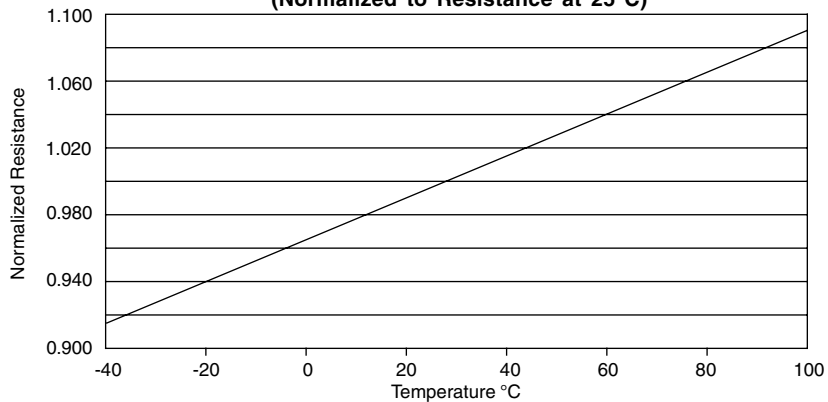

GRAPHS

FIGURE 2
OVERSHOOT & CLAMPING VOLTAGE

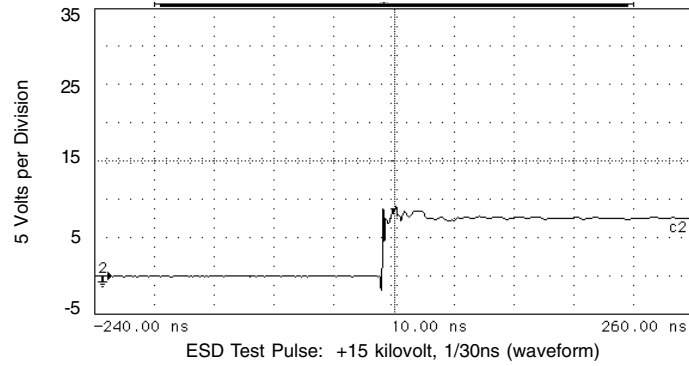
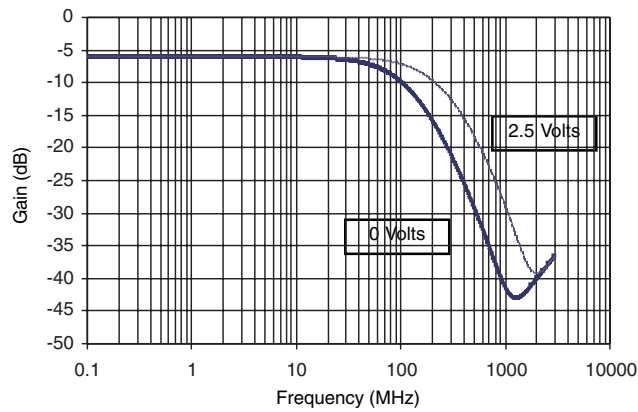

FIGURE 3
INSERTION LOSS



APPLICATION INFORMATION

PRINTED CIRCUIT BOARD RECOMMENDATIONS	
PARAMETER	VALUE
Pad Size on PCB	0.275mm
Pad Shape	Round
Pad Definition	Non-Solder Mask Defined Pads
Solder Mask Opening	0.325mm Round
Solder Stencil Thickness	0.150mm
Solder Stencil Aperture Opening (laser cut, 5% tapered walls)	0.330mm Round
Solder Paste Type	No Clean
Pad Protective Finish	OSP(Entek Cu Plus 106A)
Tolerance - Edge To Corner Ball	±50µm
Solder Ball Side Coplanarity	±20µm
Maximum Dwell Time Above Liquidous (183°C)	60 Seconds
Soldering Maximum Temperature	270°C

REQUIREMENTS
Temperature: T_P for Lead-Free (SnAgCu): 260-270°C T_P for Tin-Lead: 240-245°C Preheat time and temperature depends on solder paste and flux activation temperature, component size, weight, surface area & plating.

RECOMMENDED NON-SOLDER MASK DEFINED PAD ILLUSTRATION

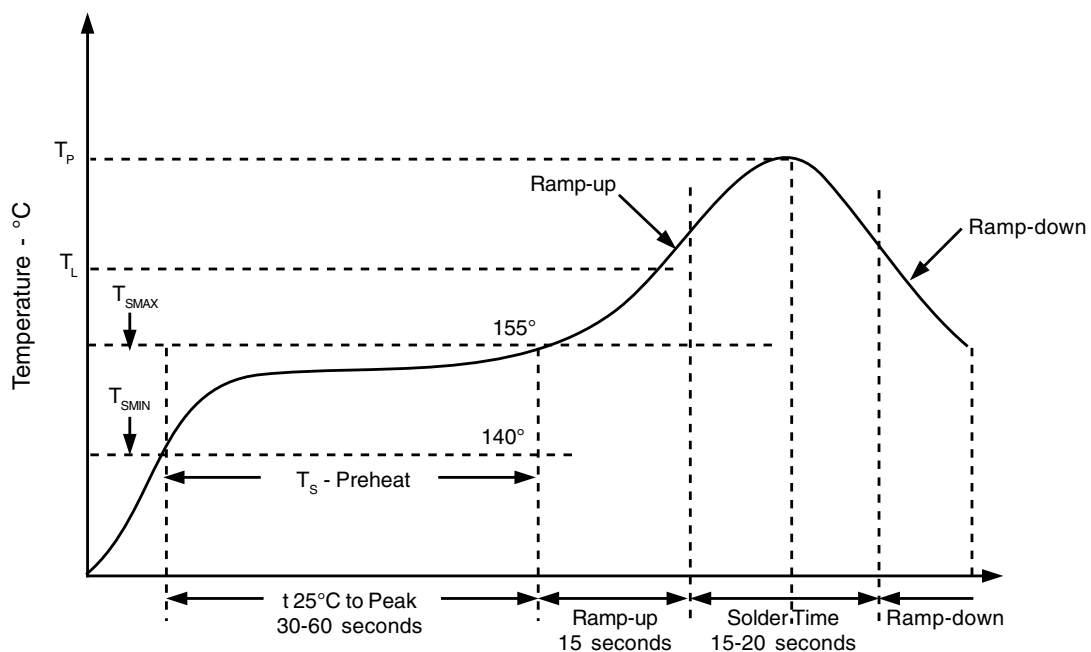
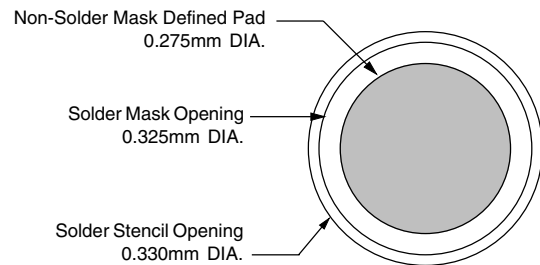

PACKAGE OUTLINE & DIMENSIONS

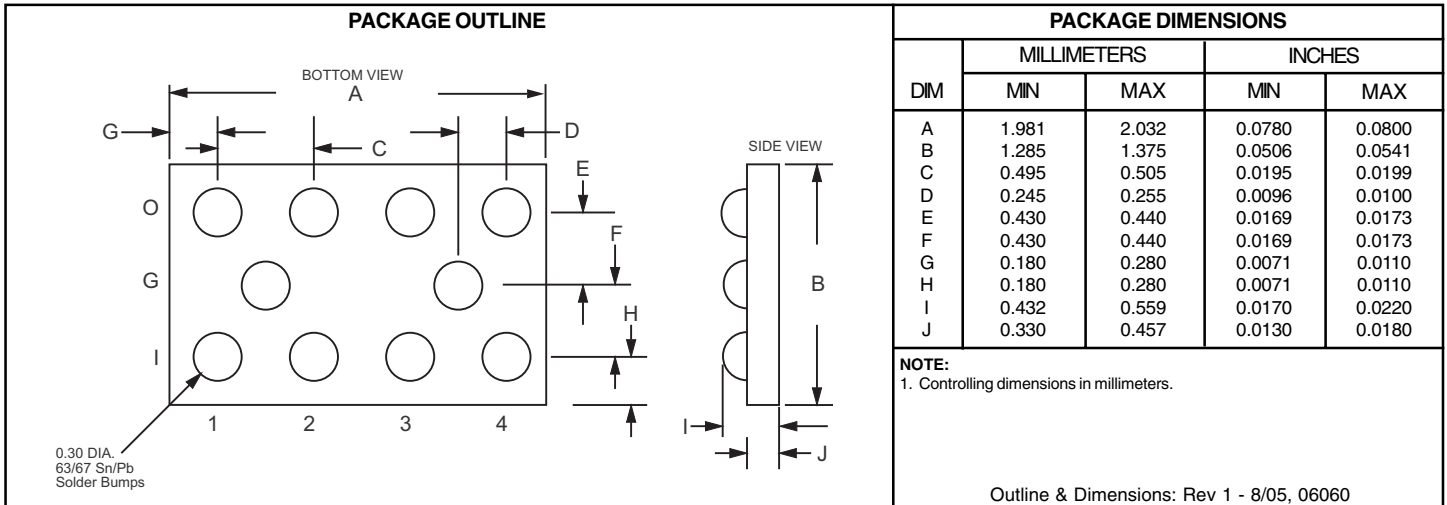

Tape & Reel Specifications (Dimensions in millimeters)

Reel Dia.	Tape Width	A0	B0	K0	D	E	F	W	P0	P2	P	t
178mm (7")	8mm	1.78 ± 0.05	2.18 ± 0.05	0.51 ± 0.05	1.50 ± 0.10	1.75 ± 0.10	3.50 ± 0.05	8.00 ± 0.30	4.00 ± 0.10	2.00 ± 0.05	4.00 ± 0.10	0.20 ± 0.025

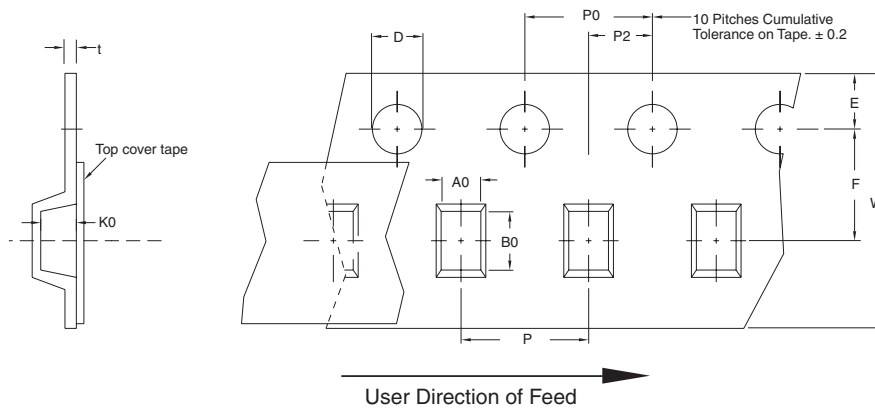

TAPE & REEL ORDERING NOMENCLATURE

1. Surface mount product is taped and reeled in accordance with EIA-481.
2. Plastic 8mm Tape: Suffix-T73-1 = 7 Inch Reel - 3,000 pieces per reel, i.e., *EMIF4-100LFC-T73-1*.
3. Suffix - LF - Lead-Free, i.e., *EMIF4-100LFC-LF-T73-1*.

COPYRIGHT © ProTek Devices 2005

SPECIFICATIONS: ProTek reserves the right to change the electrical and or mechanical characteristics described herein without notice (except JEDEC).

DESIGN CHANGES: ProTek reserves the right to discontinue product lines without notice, and that the final judgement concerning selection and specifications is the buyer's and that in furnishing engineering and technical assistance, ProTek assumes no responsibility with respect to the selection or specifications of such products.

ProTek Devices
 2929 South Fair Lane, Tempe, AZ 85282
 Tel: 602-431-8101 Fax: 602-431-2288
 E-Mail: sales@protekdevices.com
 Web Site: www.protekdevices.com