

E-Series Surface Mount Mixer
2110 – 2170 MHz

EFM-2100
V2

Features

- LO Power +13 dBm
- +22dB Compression Point
- Surface Mount
- +32dBm IIP3
- Up and Down Converting
- Tape and reel packaging available

Description

M/A Com's EFM-2100 uses a novel, patent pending design to achieve very high linearity at low LO drive levels. Typically IP3 performance is +32dBm with an LO drive level of just +13dBm. The mixer combines PHEMT devices and carefully matched transformers in a surface mount package which can be used for both up and down converting. It is ideally suited for wireless applications where high linearity is required. Parts are packaged in tape & reel.

SM - 106 - Non Hermetic Package

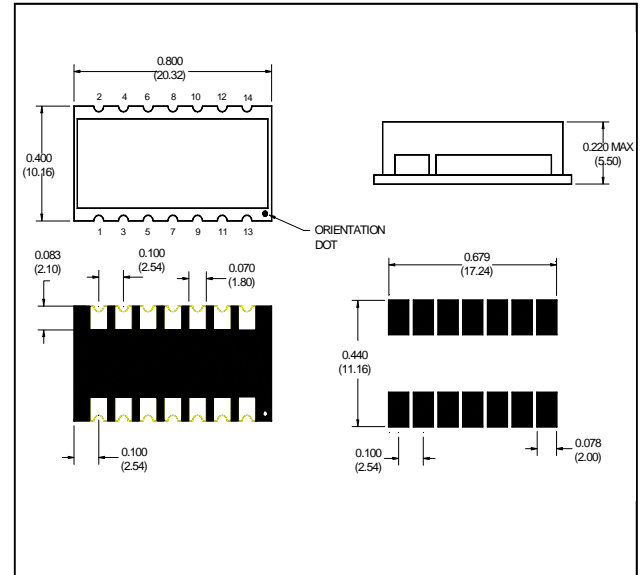

Electrical Specifications: $T_A = 25^\circ\text{C}$, $Z_0 = 50\Omega$ ¹

Parameter	Test Conditions	Frequency	Units	Min	Typ	Max
RF Frequency	DC bias 3V ± 0.3V	2110 - 2170	MHz	—	—	—
LO Frequency	DC bias 3V ± 0.3V	1650 - 2070	MHz	—	—	—
IF Frequency	DC bias 3V ± 0.3V	100 - 500	MHz	—	—	—
Conversion Loss	—	2110 - 2170	dB	-	8.5	10.0
Isolation	LO to RF	1650 - 2070	dB	10.0	16.0	—
Isolation	LO to IF	1650 - 2070	dB	20.0	25.0	—
Isolation	RF to IF	2110 - 2170	dB	25	35	—
VSWR	LO	1650 - 2070	—	—	2.5	—
VSWR	RF	2110 - 2170	—	—	2.8	—

Ordering Information

Part Number	Package
EFM-2100TR	Tape and Reel (300 piece Reel)

E-Series Surface Mount Mixer
2110 – 2170 MHz

EFM-2100
V2

Electrical Specifications: $T_A = 25^\circ\text{C}$, $Z_0 = 50\Omega$ ¹

Parameter	Test Conditions	Frequency	Units	Min	Typ	Max
IF VSWR	—	100 - 500	—	—	1.8	—
Input IP3	Up Converting	—	dBm	30.0	34.0	—
Input IP3	Down Converting	—	dBm	30.0	34.0	—
Input 1dB Compression	—	1850 - 1980	dBm	—	22.0	—

Pin Configuration

Pin No.	Function		
1	Ground	8	Ground
2	RF	9	LO
3	Ground	10	Ground
4	Ground	11	Ground
5	Ground	12	Ground
6	Ground	13	Bias
7	Ground	14	IF

Schematic

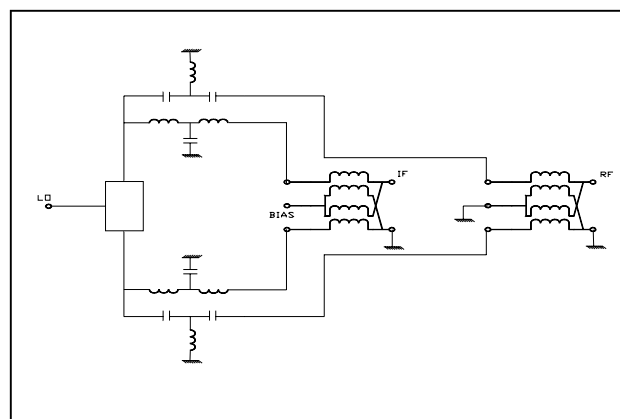

Absolute Maximum Ratings ¹

Parameter	Absolute Maximum
Max RF Power	200 mW
Peak IF Current	40 mA
Operating Temperature	-40°C to +85°C
Storage Temperature	-55°C to +125°C
ESD Rating	Zero

1. Operation of this device above any one of these parameters may cause permanent damage.

Typical Performance Curves

Conversion Loss

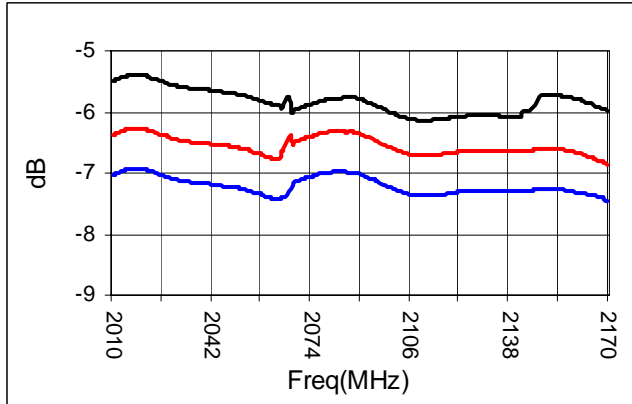

LO - RF Isolation

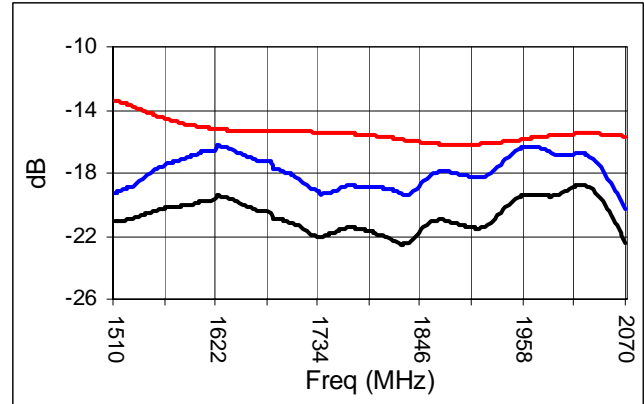

LO—IF Isolation

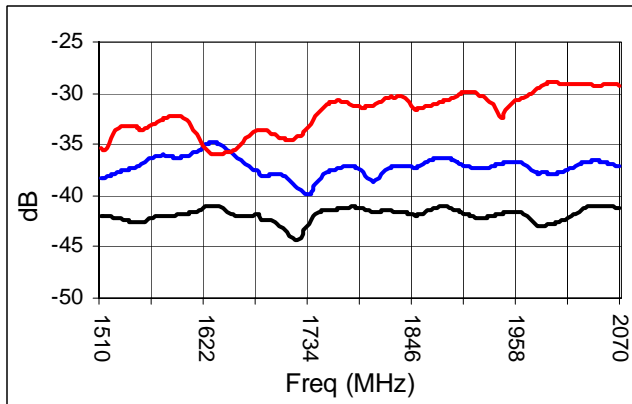

IIP3

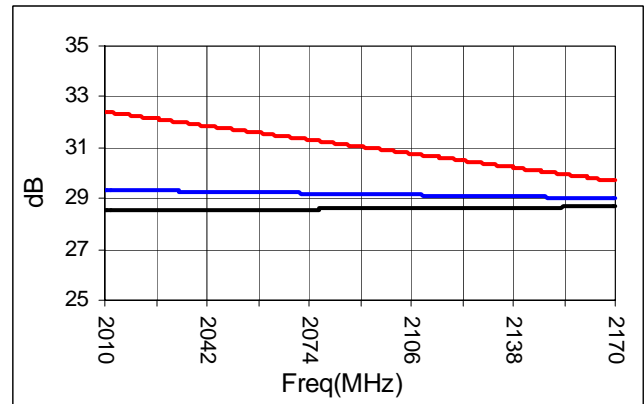

1 dB Compression Point

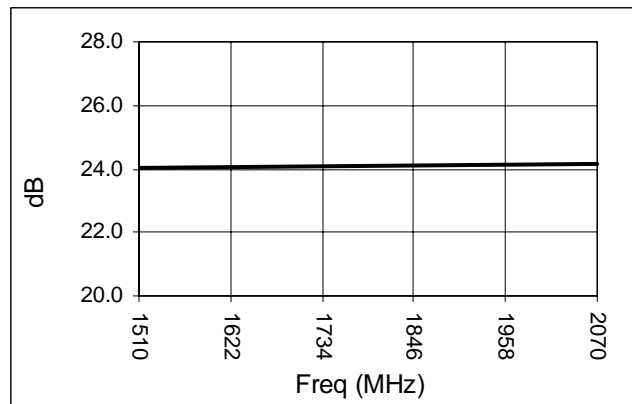

E-Series Surface Mount Mixer
2110 – 2170 MHz

EFM-2100
V2

Spurious Table: 2100MHz

(In dBc below IF, assuming down conversion)

		nf _{LO} - mf _{RF}				
	0	X	9	17	22	30
	1	35	0	37	57	45
RF	2	77	77	56	77	77
(n)	3	77	77	77	70	77
	4	77	77	77	77	77
		0	1	2	3	4

LO (m)

RF = 2110 MHz, 0dBm
LO = 2010 MHz, +13dBm
IF = 100 MHz

Spurious Table: 2100MHz

(In dBc below IF, assuming down conversion)

		nf _{LO} - mf _{RF}				
	0	X	8	12	10	23
	1	25	0	28	59	61
RF	2	77	77	62	52	77
(n)	3	77	77	77	77	70
	4	77	77	77	77	77
		0	1	2	3	4

LO (m)

RF = 2100 MHz, 0dBm
LO = 1610 MHz, +13dBm
IF = 500 MHz

Spurious Table: 2170MHz

(In dBc below IF, assuming down conversion)

		nf _{LO} - mf _{RF}				
	0	X	10	13	22	32
	1	33	0	45	59	47
RF	2	70	77	48	74	69
(n)	3	71	77	77	66	77
	4	77	77	77	77	77
		0	1	2	3	4

LO (m)

RF = 2170 MHz, 0dBm
LO = 2070 MHz, +13dBm
IF = 100 MHz

Spurious Table: 2170MHz

(In dBc below IF, assuming down conversion)

		nf _{LO} - mf _{RF}				
	0	X	10	12	16	17
	1	34	0	39	54	65
RF	2	73	77	65	60	77
(n)	3	77	77	77	77	77
	4	77	77	77	77	77
		0	1	2	3	4

LO (m)

RF = 2170 MHz, 0dBm
LO = 1670 MHz, +13dBm
IF = 500 MHz