

DG - 211V

The DG – 211V carrying a unique hysteresis transistor (BAMBIT) developed by KODENSHI CORP. facilitates digital output by means of two leads.

FEATURES

- DIGITAL OUTPUT : directly connect to a microcomputer digital port.
- HYSTERESIS : stable against chattering of the object
- HIGH– SPEED RESPONSE: faster than phototransistor type
- Setting easy

APPLICATIONS

- Detection of paper or marks
- Detection of high – speed object
- Detection of bar codes

DIMENSIONS

(Unit : mm)

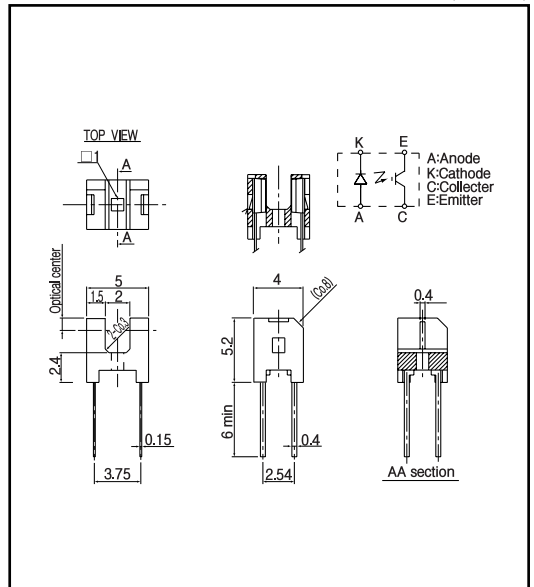

MAXIMUM RATINGS

(Ta=25)

Item	Symbol	Rating	Unit
Input	Power dissipation	P _D	75 mW
	Forward current	I _F	50 mA
	Reverse voltage	V _R	5 V
Output	Collector current	I _C	0.5 mA
	C - E voltage	V _{CEO}	10 V
	E - C voltage	V _{ECO}	0.3 V
Operating temp. ^{*1}		Topr.	- 20 ~ +80
Soldering temp. ^{*2}		Tsol.	240

*1. No icebound or dew

*2. For MAX.5 seconds at the position of 1mm from the package

ELECTRO-OPTICAL CHARACTERISTICS

(Ta=25)

Item	Symbol	Conditions	Min.	Typ.	Max.	Unit.
Input	Forward voltage	I _F = 20mA		1.2	1.4	V
	Reverse current	V _R = 5V			10	μA
	Peak wavelength	I _F = 20mA		940		nm
Output	Operating supply voltage rang	V _{CC}	2.0		5.5	V
	Low level output voltage	V _{OL} V _{CC} = 3V, I _F = 0mA, R _E = 100k		0.35	0.5	V
	High level output voltage	V _{OH} V _{CC} = 3V, I _F = 8mA, R _E = 100k	2.5	2.65		V
	Peak wavelength	p		880		nm
Transmission	Threshold input current ^{*4}	I _{FLH} V _{CC} = 3V, R _E = 100k		2.8	6.0	mA
	Hysteresis ^{*5}	I _{FHL} /I _{FLH} V _{CC} = 3V, R _E = 100k		0.85		
	L H propagation time	t _{PLH} V _{CC} = 3V, I _F = 12mA, R _E = 100k		15		μsec.
	H L propagation time	t _{PHL}		40		μsec.
	Rise time	t _r		4		μsec.
Fall time	t _f		30		μsec.	

*4. IFLH represents forward current when output changes from low to high.

*5. IFHL represents forward current when output changes from high to low.

Photointerrupters(Transmissive)

DG - 211V

Power dissipation Vs. Ambient temperature

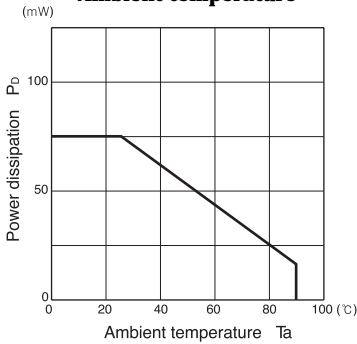

Threshold input current Vs. Ambient temperature

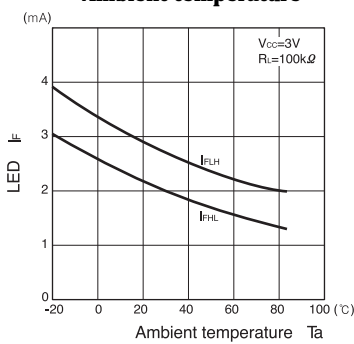

Forward current Vs. Forward voltage

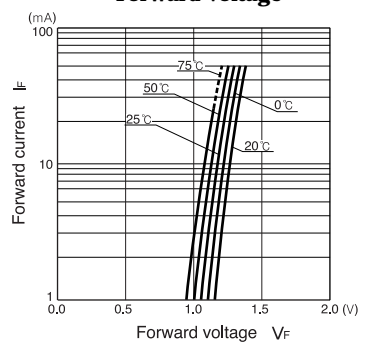

Output voltage Vs. Ambient temperature

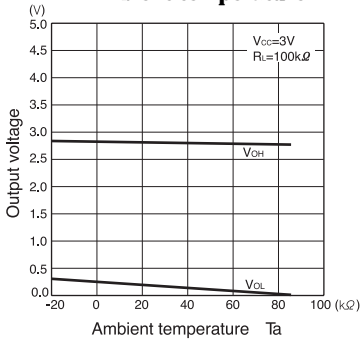

LED Vs. Supply voltage

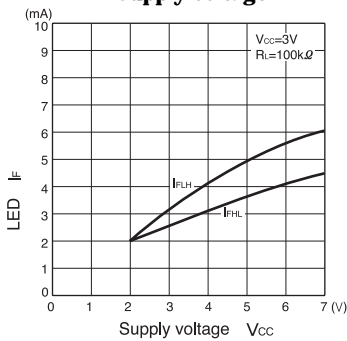

LED Vs. Load resistance

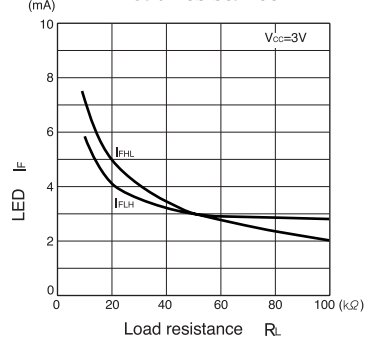

Hysteresis width Vs. Load resistance

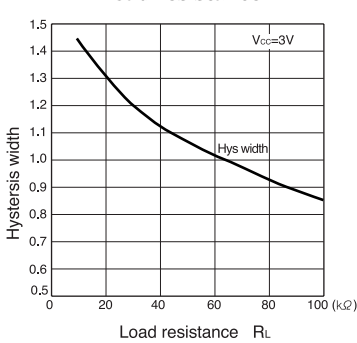

Hysteresis width Vs. Ambient temperature

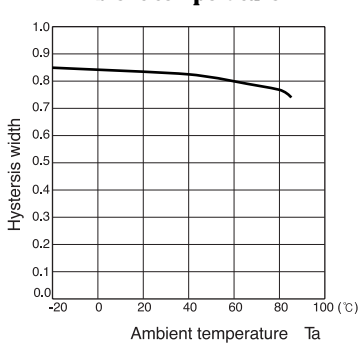

Switching current Vs. Load resistance

