

# SHINDENGEN

## Super Fast Recovery Rectifiers

Single

# D4L40

## 400V 4A

### FEATURES

- Low noise
- trr50ns
- Fully Isolated Molding

### APPLICATION

- Switching power supply
- Free Wheel
- Home Appliances, Office Equipment
- Telecommunication, Factory Automation

### OUTLINE DIMENSIONS

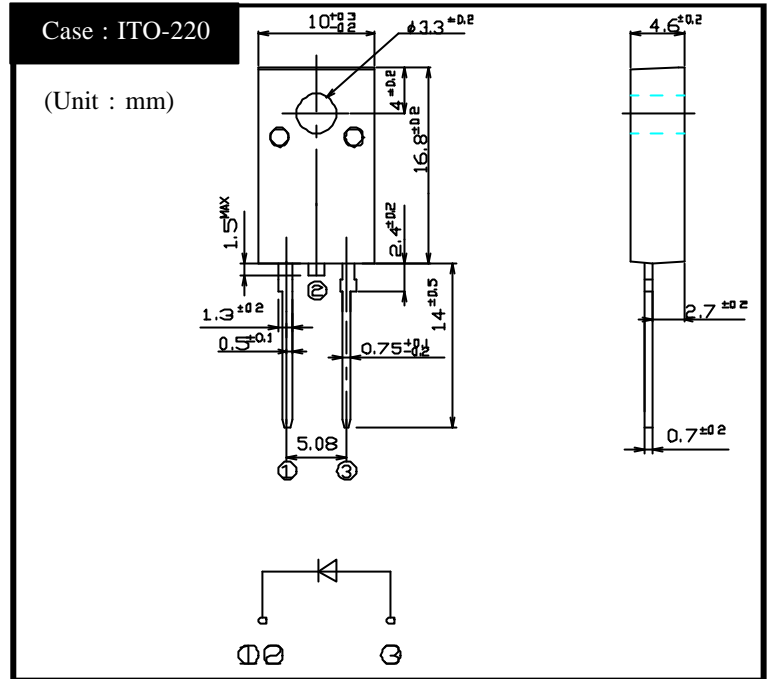

### RATINGS

Absolute Maximum Ratings (If not specified Tc=25 )

Item	Symbol	Conditions	Ratings	Unit
Storage Temperature	Tstg		-40 ~ 150	
Operating Junction Temperature	Tj		150	
Maximum Reverse Voltage	V <sub>RM</sub>		400	V
Average Rectified Forward Current	I <sub>o</sub>	50Hz sine wave, R-load, Tc=125	4	A
Peak Surge Forward Current	I <sub>FSM</sub>	50Hz sine wave, Non-repetitive 1 cycle peak value, Tj=25	60	A
Dielectric Strength	V <sub>dis</sub>	Terminals to case, AC 1 minute	1.5	kV
Mounting Torque	TOR	(Recommended torque :0.3N·m)	0.5	N·m

Electrical Characteristics (If not specified Tc=25 )

Item	Symbol	Conditions	Ratings	Unit
Forward Voltage	V <sub>F</sub>	I <sub>F</sub> =4A, Pulse measurement	Max.1.3	V
Reverse Current	I <sub>R</sub>	V <sub>R</sub> =V <sub>RM</sub> , Pulse measurement	Max.10	μA
Reverse Recovery Time	trr	I <sub>F</sub> =0.5A, I <sub>R</sub> =1A	Max.50	ns
Thermal Resistance	jc	junction to case	Max.4.5	/W

# D4L40

## Forward Voltage

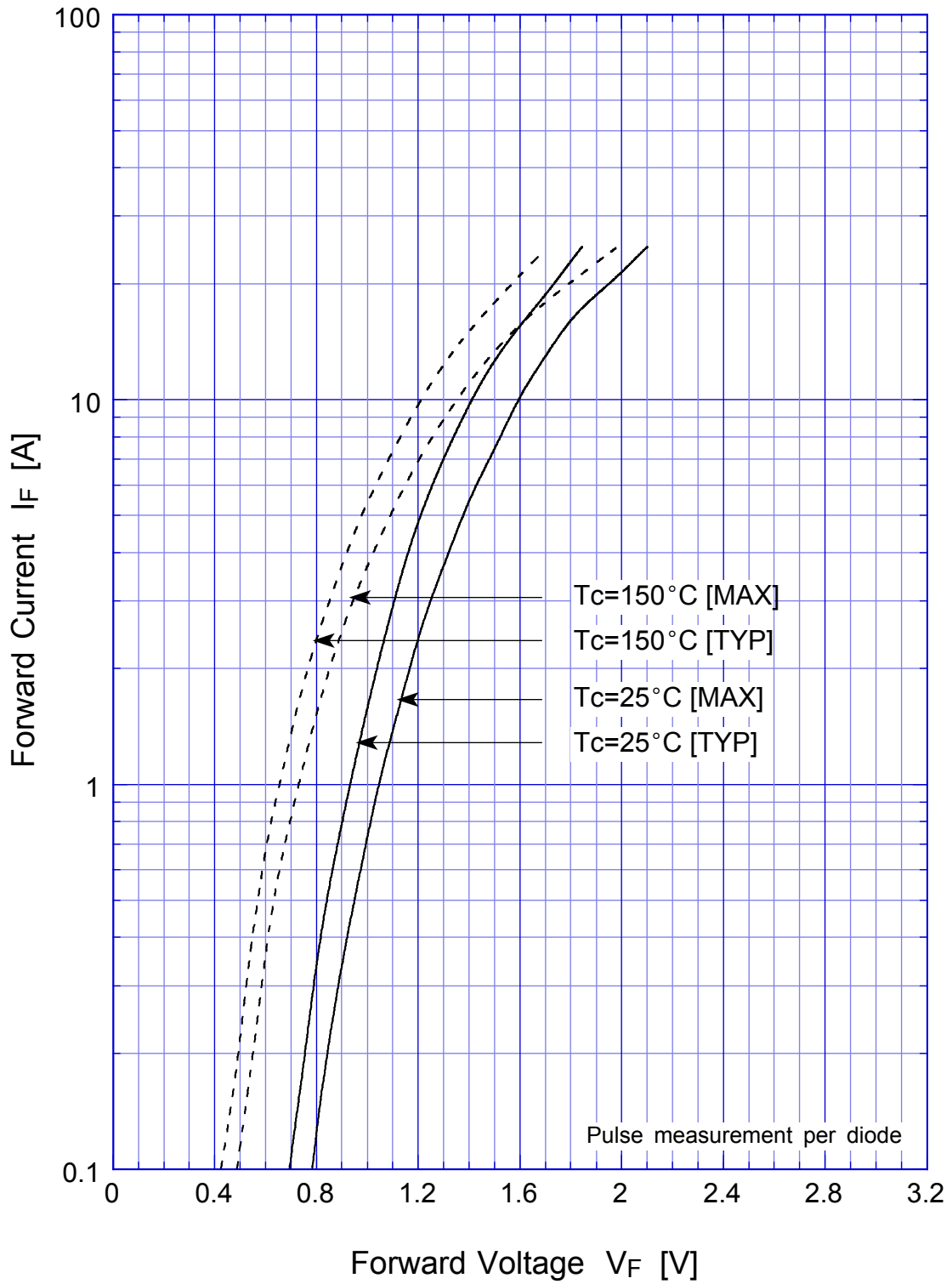

# D4L40

## Forward Power Dissipation

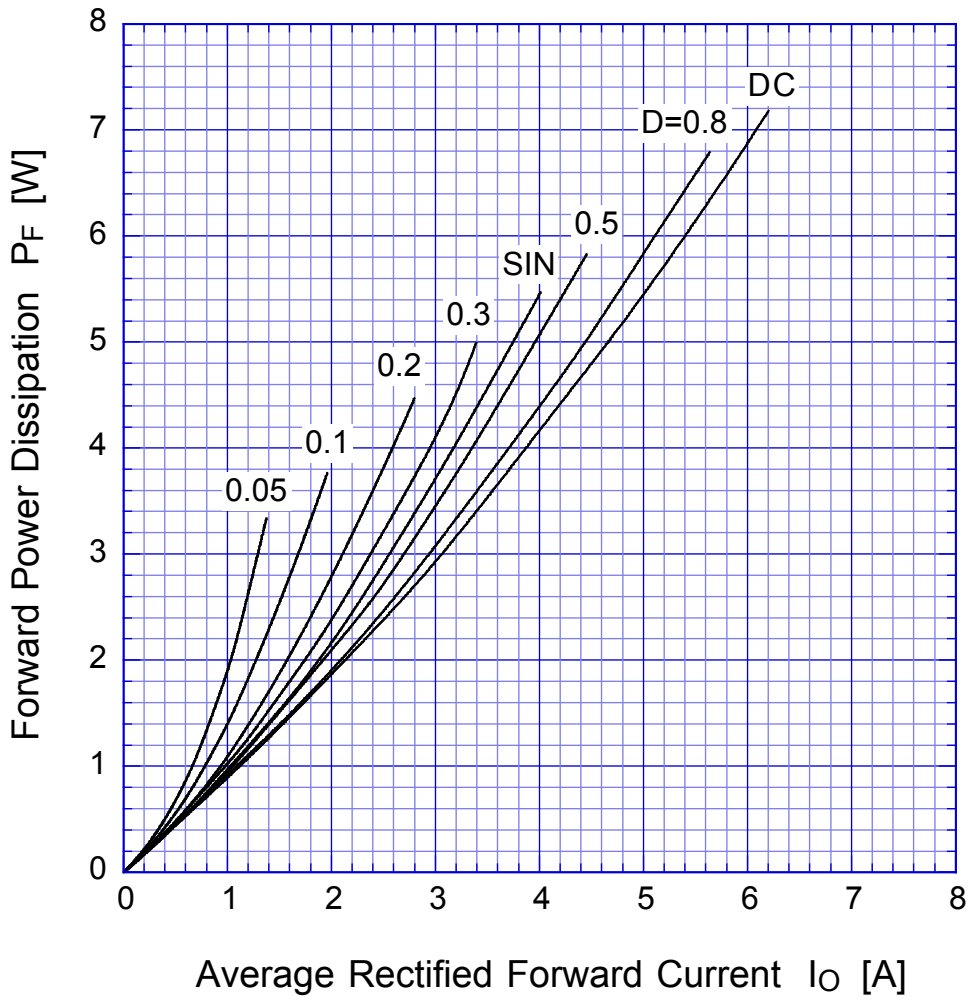

$T_j = T_{jmax}$

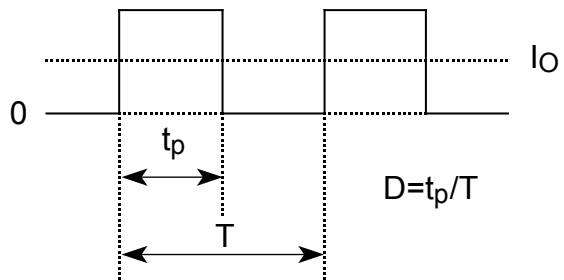

# D4L40

# Derating Curve

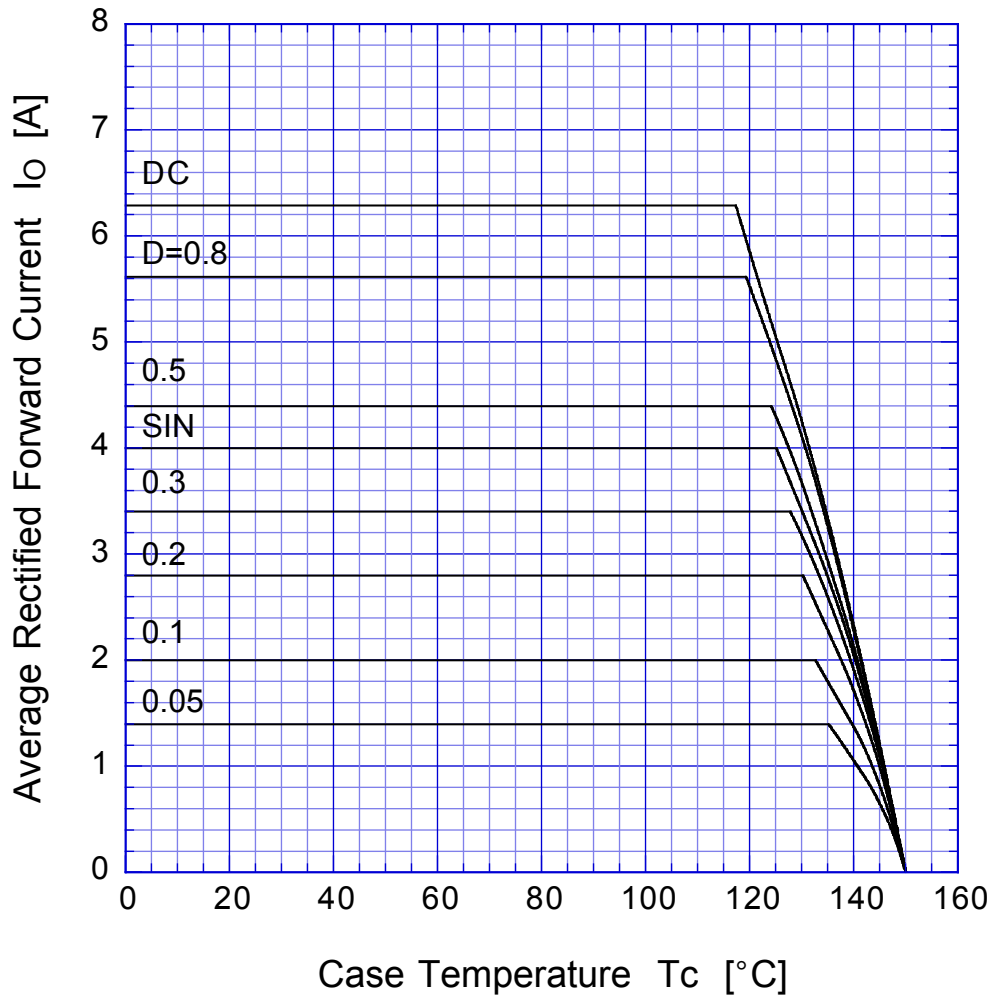

$$V_R = V_{RM}$$



# D4L40

# Derating Curve

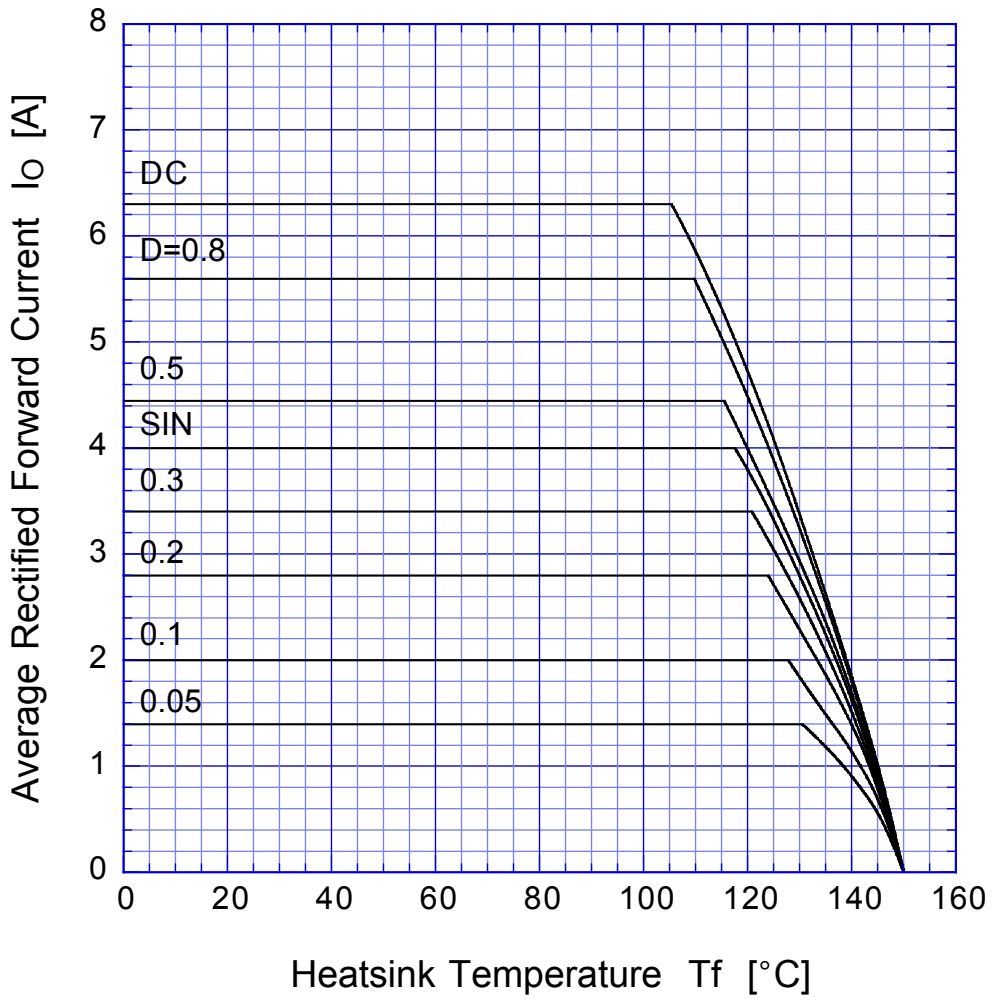

$$V_R = V_{RM}$$



# D4L40

## Peak Surge Forward Capability

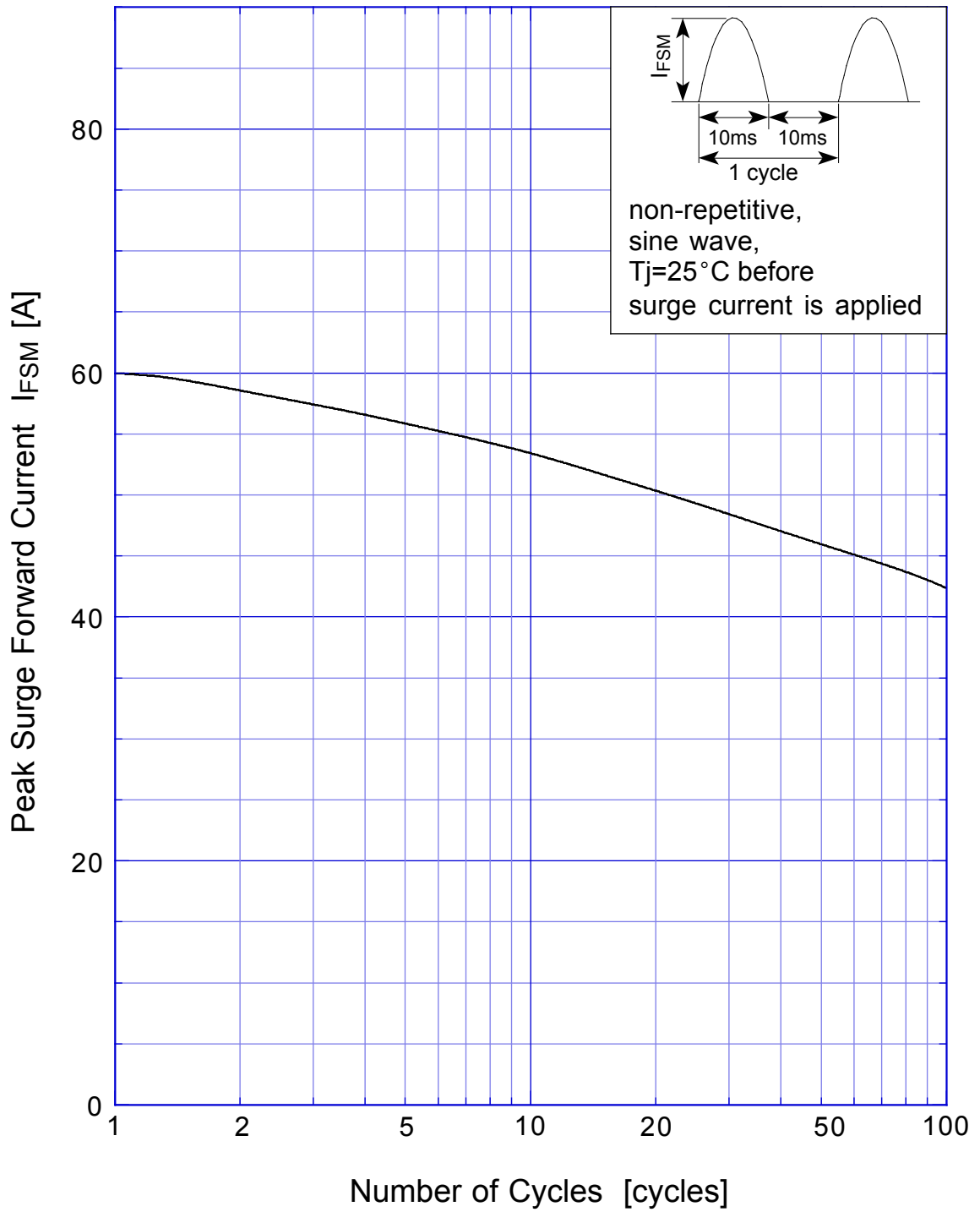

# D4L40

## Junction Capacitance

