

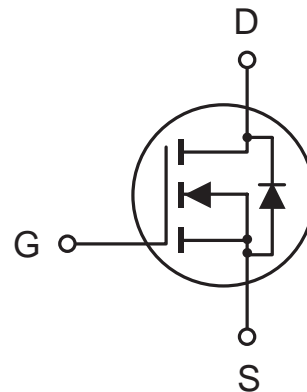
# CED71A3/CEU71A3

Dec. 2002

## N-Channel Logic Level Enhancement Mode Field Effect Transistor

### FEATURES

- 30V , 65A ,  $R_{DS(ON)}=10m\Omega$  @  $V_{GS}=10V$ .  
 $R_{DS(ON)}=14m\Omega$  @  $V_{GS}=5.0V$ .
- Super high dense cell design for extremely low  $R_{DS(ON)}$ .
- High power and current handling capability.
- TO-252 & TO-251 package.



6

### ABSOLUTE MAXIMUM RATINGS ( $T_c=25^\circ\text{C}$ unless otherwise noted)

Parameter	Symbol	Limit	Unit
Drain-Source Voltage	$V_{DS}$	30	V
Gate-Source Voltage	$V_{GS}$	$\pm 20$	V
Drain Current-Continuous -Pulsed	$I_D$	65	A
	$I_{DM}$	100	A
Drain-Source Diode Forward Current	$I_S$	65	A
Maximum Power Dissipation @ $T_c=25^\circ\text{C}$ Derate above $25^\circ\text{C}$	$P_D$	69	W
		0.56	W/ $^\circ\text{C}$
Operating and Storage Temperature Range	$T_J, T_{STG}$	-55 to 150	$^\circ\text{C}$

### THERMAL CHARACTERISTICS

Thermal Resistance, Junction-to-Case	$R_{\theta JC}$	1.8	$^\circ\text{C/W}$
Thermal Resistance, Junction-to-Ambient	$R_{\theta JA}$	40	$^\circ\text{C/W}$

# CED71A3/CEU71A3

## ELECTRICAL CHARACTERISTICS (Tc=25°C unless otherwise noted)

6

Parameter	Symbol	Condition	Min	Typ	Max	Unit
<b>OFF CHARACTERISTICS</b>						
Drain-Source Breakdown Voltage	BV <sub>DSS</sub>	V <sub>GS</sub> = 0V, I <sub>D</sub> = 250μA	30			V
Zero Gate Voltage Drain Current	I <sub>DSS</sub>	V <sub>DS</sub> = 30V, V <sub>GS</sub> = 0V			1	μA
Gate-Body Leakage	I <sub>GSS</sub>	V <sub>GS</sub> = ±20V, V <sub>DS</sub> = 0V			±100	nA
<b>ON CHARACTERISTICS<sup>a</sup></b>						
Gate Threshold Voltage	V <sub>GS(th)</sub>	V <sub>DS</sub> = V <sub>GS</sub> , I <sub>D</sub> = 250μA	1		3	V
Drain-Source On-State Resistance	R <sub>DS(ON)</sub>	V <sub>GS</sub> = 10V, I <sub>D</sub> = 15A		8.5	10	mΩ
		V <sub>GS</sub> = 5.0V, I <sub>D</sub> = 13A		11.5	14	mΩ
On-State Drain Current	I <sub>D(ON)</sub>	V <sub>GS</sub> = 10V, V <sub>DS</sub> = 5V	65			A
Forward Transconductance	g <sub>FS</sub>	V <sub>DS</sub> = 5V, I <sub>D</sub> = 12A		26		S
<b>DYNAMIC CHARACTERISTICS<sup>b</sup></b>						
Input Capacitance	C <sub>ISS</sub>	V <sub>DS</sub> = 15V, V <sub>GS</sub> = 0V f = 1.0MHz		2152		pF
Output Capacitance	C <sub>OSS</sub>			965		pF
Reverse Transfer Capacitance	C <sub>RSS</sub>			234		pF
<b>SWITCHING CHARACTERISTICS<sup>b</sup></b>						
Turn-On Delay Time	t <sub>D(ON)</sub>	V <sub>DD</sub> = 15V, I <sub>D</sub> = 1A, V <sub>GS</sub> = 10V, R <sub>GEN</sub> = 6Ω		30	60	ns
Rise Time	t <sub>r</sub>			63	110	ns
Turn-Off Delay Time	t <sub>D(OFF)</sub>			73	130	ns
Fall Time	t <sub>f</sub>			59	100	ns
Total Gate Charge	Q <sub>g</sub>	V <sub>DS</sub> = 10V, I <sub>D</sub> = 15A, V <sub>GS</sub> = 10V		55	67	nC
Gate-Source Charge	Q <sub>gs</sub>			9		nC
Gate-Drain Charge	Q <sub>gd</sub>			18		nC

# CED71A3/CEU71A3

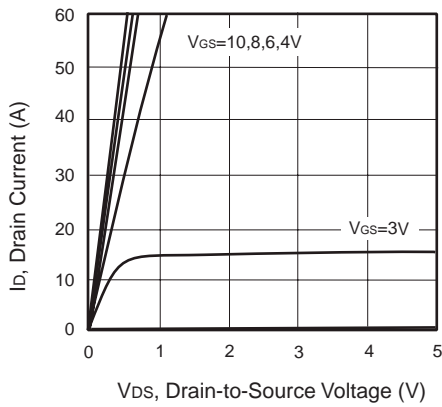
## ELECTRICAL CHARACTERISTICS ( $T_c=25^\circ\text{C}$ unless otherwise noted)

Parameter	Symbol	Condition	Min	Typ	Max	Unit
<b>DRAIN-SOURCE DIODE CHARACTERISTICS <sup>a</sup></b>						
Diode Forward Voltage	$V_{SD}$	$V_{GS} = 0V, I_s = 2.3A$		0.9	1.3	V

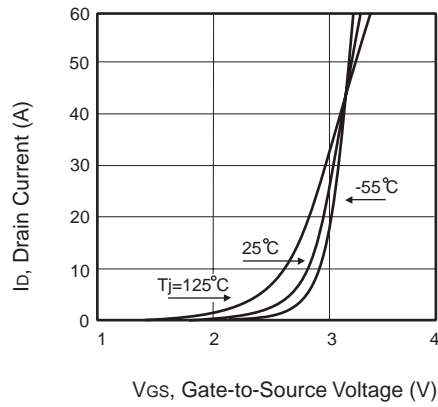
6

**Notes**

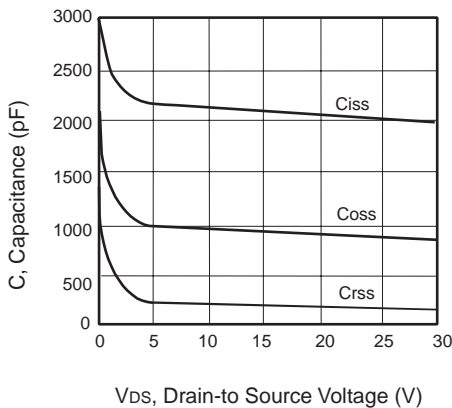
- a. Pulse Test: Pulse Width  $\leq 300 \mu s$ , Duty Cycle  $\leq 2\%$ .
- b. Guaranteed by design, not subject to production testing.



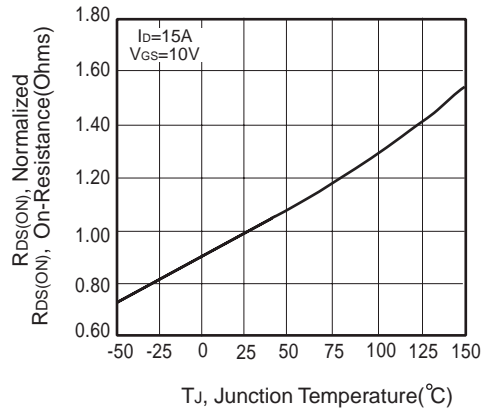
**Figure 1. Output Characteristics**



**Figure 2. Transfer Characteristics**



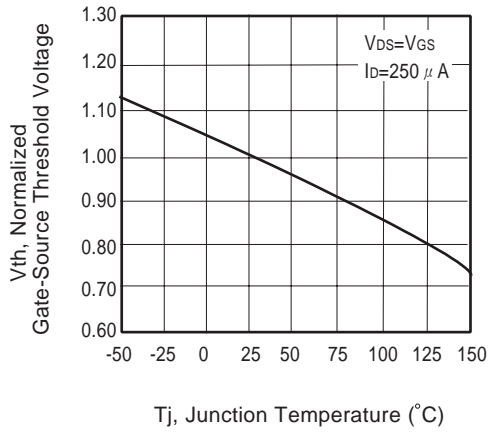
**Figure 3. Capacitance**



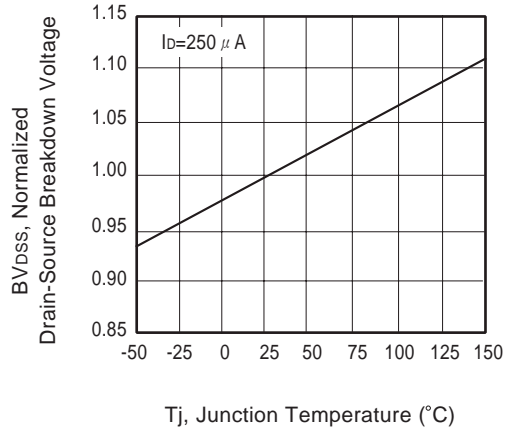
**Figure 4. On-Resistance Variation with Temperature**

# CED71A3/CEU71A3

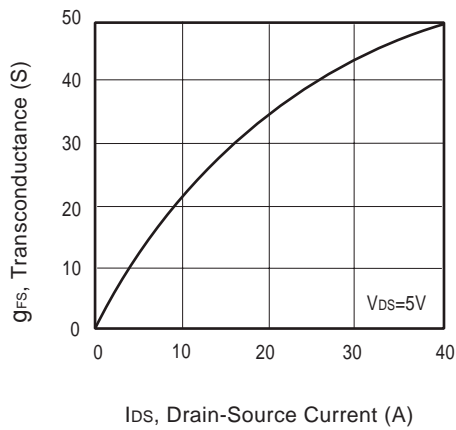
6



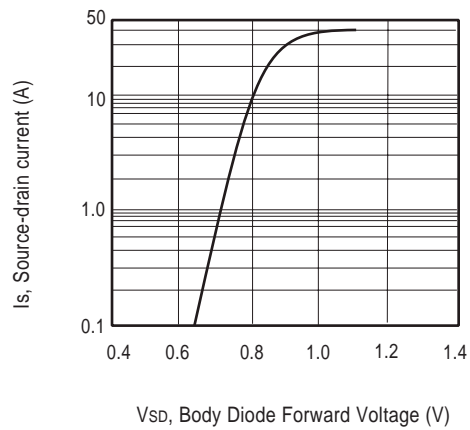
**Figure 5. Gate Threshold Variation with Temperature**



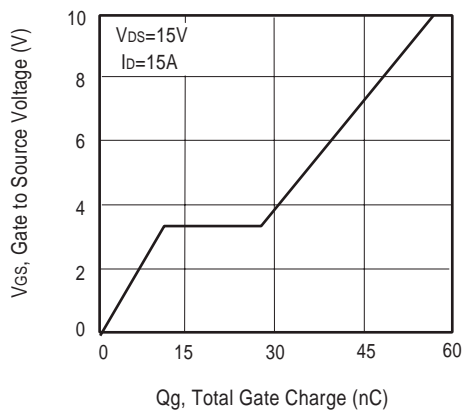
**Figure 6. Breakdown Voltage Variation with Temperature**



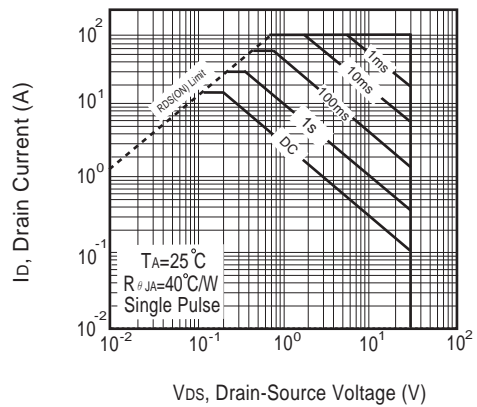
**Figure 7. Transconductance Variation with Drain Current**



**Figure 8. Body Diode Forward Voltage Variation with Source Current**

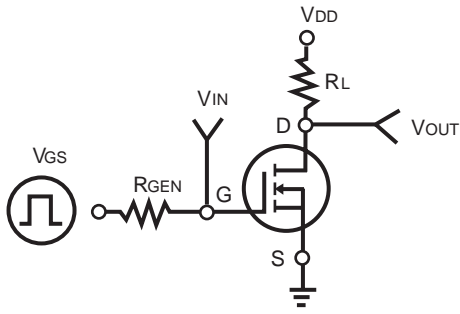


**Figure 9. Gate Charge**

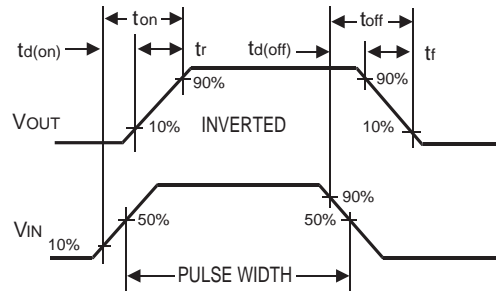


**Figure 10. Maximum Safe Operating Area**

# CED71A3/CEU71A3

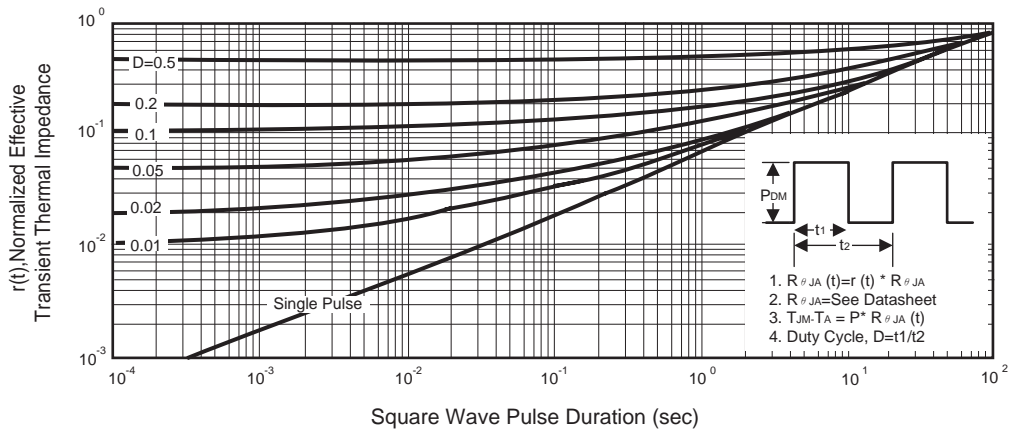


**Figure 11. Switching Test Circuit**



**Figure 12. Switching Waveforms**

6



**Figure 13. Normalized Thermal Transient Impedance Curve**