

Long-life grade capacitors

Applications

- Professional switch-mode power supplies in industrial electronics and in data processing equipment
- Switch-mode power supplies in entertainment electronics
- Frequency converters

Features

- High reliability
- High CU product, extremely compact
- Low equivalent series resistance *ESR*
- Many different case sizes available for each capacitance value

Construction

- Charge-discharge proof, polar
- Aluminum case, fully insulated
- Snap-in solder pins to hold component in place on PC-board
- Minus pole marking on case surface
- Minus pole not insulated from case
- Overload protection (safety vent)

Terminals

- Standard version with 2 terminals
2 lengths available: 6,3 and 4,5 mm
- 3 terminals: length 4,5 mm
(terminal arrangement ensures correct insertion)

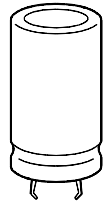

KAL0274-A

Specifications and characteristics in brief

Rated voltage U_R	200 ... 450 VDC	
Surge voltage U_S	$1,15 \cdot U_R$ (for $U_R \leq 250$ VDC) $1,10 \cdot U_R$ (for $U_R \geq 400$ VDC)	
Rated capacitance C_R	47 ... 2 200 μF	
Capacitance tolerance	$\pm 20 \% \triangleq \text{M}$	
Dissipation factor $\tan \delta$ (20 °C, 120 Hz)	$U_R \leq 400$ VDC: $\tan \delta \leq 0,15$ $U_R \geq 420$ VDC: $\tan \delta \leq 0,20$	
Leakage current I_L (5 min, 20 °C)	$I_L \leq 0,3 \mu\text{A} \cdot \left(\frac{C_R}{\mu\text{F}} \cdot \frac{U_R}{\text{V}} \right)^{0,7} + 4 \mu\text{A}$	
Self-inductance ESL	Approx. 20 nH	
Useful life 105 °C; U_R ; I_{-R} 85 °C; U_R ; I_{-max} 40 °C; U_R ; $1,9 \cdot I_{-R}$	$> 3\ 000$ h $> 6\ 500$ h $> 200\ 000$ h	Requirements: $\Delta C/C \leq \pm 30\%$ of initial value $\tan \delta \leq 3$ times initial specified limit $I_L \leq$ initial specified limit Failure percentage: $\leq 1\%$ Failure rate: ≤ 40 fit ($\leq 40 \cdot 10^{-9}/\text{h}$) (for definition "fit", refer to chapter "Quality", page 62)
Load life test 105 °C; U_R ; I_{-R}	2 000 h	Post test requirements: $\Delta C/C \leq \pm 20\%$ of initial value $\tan \delta \leq 2$ times initial specified limit $I_L \leq$ initial specified limit
Voltage endurance test 105 °C; U_R	2 000 h	Post test requirements: $\Delta C/C \leq \pm 10\%$ of initial value $\tan \delta \leq 1,3$ times specified limit $I_L \leq$ initial specified limit
Vibration resistance	To IEC 60068-2-6, test Fc: displacement amplitude 0,35 mm, frequency range 10 ... 55 Hz, acceleration max. 5 g, duration 3×2 h	
IEC climatic category	To IEC 60068-1: $U_R \leq 400$ VDC: 40/105/56 (– 40 °C/+ 105 °C/56 days damp heat test) $U_R \geq 420$ VDC: 25/105/56 (– 25 °C/+ 105 °C/56 days damp heat test)	
Detail specification	Similar to CECC 30301-809	
Sectional specification	IEC 60384-4	

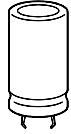
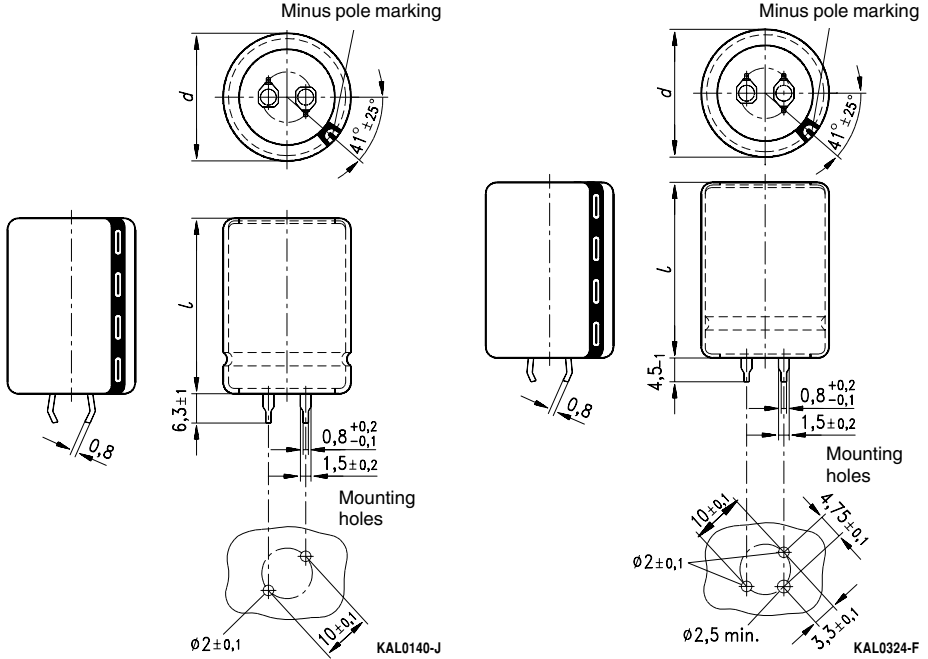
Dimensional drawings

Snap-in terminals, standard (length $6,3 \pm 1$ mm). Also available in a shorter version with a length of $4,5 - 1$ mm. For packing mode and ordering example see next page.

Snap-in capacitors are also available with 3 terminals (length $4,5 - 1$ mm).

For packing mode and ordering example see next page.

Dimensions (mm)		Approx. weight (g)	Packing units (pieces)
$d + 1$	$l \pm 2$		
22	25	9	160
22	30	12	160
22	35	15	160
22	40	18	160
22	50	24	160
<hr/>			
25	25	13	130
25	30	17	130
25	35	19	130
25	40	22	130
25	45	26	130
25	50	30	130

Dimensions (mm)		Approx. weight (g)	Packing units (pieces)
$d + 1$	$l \pm 2$		
30	25	17	80
30	30	23	80
30	35	29	80
30	40	36	80
30	45	41	80
30	50	47	80
<hr/>			
35	25	22	60
35	30	29	60
35	35	36	60
35	40	41	60
35	45	57	60
35	50	72	60



B43504

Compact – 105 °C

Packing of snap-in capacitors



For ecological reasons the packing is pure cardboard. Components can be withdrawn (in full or in part) in the correct position for insertion.

Ordering codes

Snap-in terminals Version	Identification in 3rd block of ordering code
Standard terminals (6,3 ± 1) mm	M000
Short terminals (4,5 – 1) mm	M007
3 terminals (4,5 – 1) mm	M002

Ordering example:

B43504A9107M007 } snap-in capacitor with short terminals
B43504A9107M002 } snap-in capacitor with 3 terminals

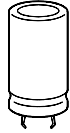
Overview of available types

U_R (VDC)	200	250	400	420	450
C_R (μ F)	Case dimensions $d \times l$ (mm)				
47			22 × 25		
68			22 × 25		22 × 30
82			22 × 30	22 × 30	22 × 35
100			22 × 35 25 × 25	22 × 35 25 × 30	22 × 35 25 × 30 30 × 25
120			22 × 35	22 × 40 25 × 30	25 × 35
150			22 × 40 30 × 25	25 × 35 30 × 30	25 × 40 30 × 30 35 × 25
180			25 × 40 30 × 30	25 × 40 30 × 30	25 × 45
220	22 × 25	22 × 30	25 × 45 30 × 35 35 × 30	25 × 45 30 × 35	25 × 50 30 × 40 35 × 30
270	22 × 25	22 × 35	25 × 50	30 × 40	30 × 45 35 × 35
330	22 × 30	22 × 40 25 × 30	30 × 45 35 × 35	30 × 45 35 × 35	30 × 50 35 × 40
390	22 × 30	25 × 35	30 × 50	30 × 50 35 × 40	35 × 45
470	22 × 35 30 × 25	22 × 50 30 × 30	35 × 45	35 × 45	35 × 50
560	25 × 35	25 × 45	35 × 50		
680	25 × 40 35 × 25	25 × 50 30 × 40			
820	25 × 45 35 × 30	30 × 45			
1 000	30 × 35	35 × 40			
1 200	30 × 40	35 × 45			
1 500	35 × 40				
1 800	35 × 45				
2 200	35 × 50				

The capacitance and voltage ratings listed above are available in different cases upon request. Other voltage and capacitance ratings are also available upon request.

Technical data and ordering codes

U_R VDC	C_R 100 Hz 20 °C μF	Case dimensions $d \times l$ mm	ESR_{typ} 100 Hz 20 °C mΩ	Z_{max} 10 kHz 20 °C mΩ	$I_{\sim max}$ 100 Hz 40 °C A	$I_{\sim max}$ 100 Hz 85 °C A	$I_{\sim R}^{(1)}$ 100 Hz 105 °C A	Ordering code ²⁾
200	220	22 × 25	580	700	2,6	1,7	0,84	B43504E2227M000
	270	22 × 25	480	570	2,8	1,9	0,93	B43504E2277M000
	330	22 × 30	390	470	3,3	2,2	1,1	B43504A2337M000
	390	22 × 30	330	400	3,6	2,4	1,2	B43504E2397M000
	470	22 × 35	280	330	4,2	2,8	1,4	B43504E2477M000
	470	30 × 25	280	330	4,5	3,0	1,5	B43504F2477M000
	560	25 × 35	230	280	5,0	3,4	1,6	B43504E2567M000
	680	25 × 40	190	230	5,8	3,9	1,9	B43504E2687M000
	680	35 × 25	190	230	6,0	4,0	2,0	B43504F2687M000
	820	25 × 45	160	190	6,6	4,5	2,2	B43504E2827M000
	820	35 × 30	160	190	6,9	4,7	2,3	B43504A2827M000
	1 000	30 × 35	130	160	7,3	4,9	2,4	B43504E2108M000
	1 200	30 × 40	110	130	8,4	5,6	2,7	B43504E2128M000
	1 500	35 × 40	90	110	10	6,9	3,4	B43504E2158M000
	1 800	35 × 45	80	90	12	7,9	3,9	B43504E2188M000
	2 200	35 × 50	60	70	14	9,1	4,4	B43504E2228M000
250	220	22 × 30	580	700	2,7	1,8	0,89	B43504A2227M000
	270	22 × 35	480	570	3,2	2,2	1,1	B43504A2277M000
	330	22 × 40	390	470	3,7	2,5	1,2	B43504B2337M000
	330	25 × 30	390	470	3,6	2,4	1,2	B43504C2337M000
	390	25 × 35	330	400	4,2	2,8	1,4	B43504A2397M000
	470	22 × 50	280	330	4,9	3,3	1,6	B43504A2477M000
	470	30 × 30	280	330	4,7	3,2	1,6	B43504B2477M000
	560	25 × 45	230	280	5,5	3,7	1,8	B43504A2567M000
	680	25 × 50	190	230	6,3	4,2	2,1	B43504A2687M000
	680	30 × 40	190	230	6,3	4,2	2,1	B43504B2687M000
	820	30 × 45	160	190	7,2	4,9	2,4	B43504B2827M000
	1 000	35 × 40	130	160	8,4	5,7	2,8	B43504A2108M000
	1 200	35 × 45	110	130	9,6	6,5	3,2	B43504A2128M000

Preferred types

1) 120 Hz conversion factor of ripple current: $I_{\sim}(120 \text{ Hz}) = 1,03 \cdot I_{\sim}(100 \text{ Hz})$

2) Ordering code for standard terminals (6,3 mm).

To determine the ordering code for short terminals (4,5 mm) and 3 terminals (4,5 mm) see page 248.

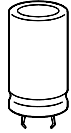

U_R	C_R 100 Hz 20 °C μF	Case dimensions $d \times l$ mm	ESR_{typ} 100 Hz 20 °C m Ω	Z_{max} 10 kHz 20 °C m Ω	I_{max} 100 Hz 40 °C A	I_{max} 100 Hz 85 °C A	$I_{\text{R}}^{(1)}$ 100 Hz 105 °C A	Ordering code ²⁾
400	47	22 × 25	1870	2310	1,2	0,79	0,39	B43504A9476M000
	68	22 × 25	1290	1600	1,4	0,95	0,47	B43504A9686M000
	82	22 × 30	1070	1320	1,7	1,1	0,55	B43504A9826M000
	100	22 × 35	880	1090	2,0	1,3	0,64	B43504A9107M000
	100	25 × 25	880	1090	1,9	1,3	0,61	B43504B9107M000
	120	22 × 35	730	910	2,1	1,4	0,70	B43504A9127M000
	150	22 × 40	590	730	2,5	1,7	0,82	B43504A9157M000
	150	30 × 25	590	730	2,5	1,7	0,83	B43504B9157M000
	180	25 × 40	490	610	3,0	2,0	0,98	B43504A9187M000
	180	30 × 30	490	610	2,9	2,0	0,96	B43504B9187M000
	220	25 × 45	400	500	3,4	2,3	1,1	B43504A9227M000
	220	30 × 35	400	500	3,4	2,3	1,1	B43504B9227M000
	220	35 × 30	400	500	3,6	2,4	1,2	B43504C9227M000
	270	25 × 50	330	410	4,0	2,7	1,3	B43504A9277M000
	330	30 × 45	270	330	4,6	3,1	1,5	B43504A9337M000
	330	35 × 35	270	330	4,6	3,1	1,5	B43504B9337M000
390	30 × 50	230	280	5,2	3,5	1,7	B43504A9397M000	
470	35 × 45	190	240	6,0	4,1	2,0	B43504A9477M000	
560	35 × 50	160	200	6,8	4,6	2,2	B43504A9567M000	
420	82	22 × 30	1650	1950	1,66	1,12	0,55	B43504A0826M000
	100	22 × 35	1360	1600	1,95	1,31	0,64	B43504A0107M000
	100	25 × 30	1360	1600	2,00	1,34	0,65	B43504E0107M000
	120	22 × 40	1130	1330	2,25	1,51	0,74	B43504A0127M000
	120	25 × 30	1130	1330	2,19	1,47	0,72	B43504E0127M000
	150	25 × 35	910	1070	2,58	1,74	0,85	B43504A0157M000
	150	30 × 30	910	1070	2,67	1,80	0,88	B43504E0157M000
	180	25 × 40	760	890	2,97	2,00	0,98	B43504A0187M000
	180	30 × 30	760	890	2,93	1,97	0,96	B43504E0187M000

Preferred types

1) 120 Hz conversion factor of ripple current: $I_{\text{R}}(120 \text{ Hz}) = 1,03 \cdot I_{\text{R}}(100 \text{ Hz})$

2) Ordering code for standard terminals (6,3 mm).

To determine the ordering code for short terminals (4,5 mm) and 3 terminals (4,5 mm) see page 248.

B43504
Compact – 105 °C

U_R	C_R 100 Hz 20 °C μF	Case dimensions $d \times l$ mm	ESR_{typ} 100 Hz 20 °C $\text{m}\Omega$	Z_{max} 10 kHz 20 °C $\text{m}\Omega$	$I_{\text{~max}}$ 100 Hz 40 °C A	$I_{\text{~max}}$ 100 Hz 85 °C A	$I_{\text{~R}}^{(1)}$ 100 Hz 105 °C A	Ordering code ²⁾
420	220	25 × 45	620	730	3,44	2,31	1,13	B43504A0227M000
	220	30 × 35	620	730	3,41	2,29	1,12	B43504E0227M000
	270	30 × 40	510	590	3,96	2,66	1,30	B43504A0277M000
	330	30 × 45	410	490	4,58	3,08	1,50	B43504A0337M000
	330	35 × 35	410	490	4,62	3,11	1,52	B43504E0337M000
	390	30 × 50	350	410	5,18	3,48	1,70	B43504A0397M000
	390	35 × 40	350	410	5,26	3,54	1,72	B43504E0397M000
	470	35 × 45	290	340	6,02	4,05	1,97	B43504A0477M000
450	68	22 × 30	1990	2350	1,5	1,0	0,50	B43504A5686M000
	82	22 × 35	1650	1950	1,8	1,2	0,58	B43504A5826M000
	100	22 × 35	1360	1600	2,0	1,3	0,64	B43504A5107M000
	100	25 × 30	1360	1600	2,0	1,3	0,65	B43504B5107M000
	100	30 × 25	1360	1600	2,1	1,4	0,67	B43504C5107M000
	120	25 × 35	1130	1330	2,3	1,6	0,76	B43504A5127M000
	150	25 × 40	910	1070	2,7	1,8	0,89	B43504A5157M000
	150	30 × 30	910	1070	2,7	1,8	0,88	B43504B5157M000
	150	35 × 25	910	1070	2,8	1,9	0,92	B43504C5157M000
	180	25 × 45	760	890	3,1	2,1	1,0	B43504A5187M000
	220	25 × 50	620	730	3,6	2,4	1,2	B43504A5227M000
	220	30 × 40	620	730	3,6	2,4	1,2	B43504B5227M000
	220	35 × 30	620	730	3,6	2,4	1,2	B43504C5227M000
	270	30 × 45	510	590	4,1	2,8	1,4	B43504A5277M000
	270	35 × 35	510	590	4,1	2,8	1,4	B43504B5277M000
	330	30 × 50	410	490	4,8	3,2	1,6	B43504A5337M000
	330	35 × 40	410	490	4,8	3,3	1,6	B43504B5337M000
	390	35 × 45	350	410	5,5	3,7	1,8	B43504A5397M000
	470	35 × 50	290	340	6,3	4,2	2,1	B43504A5477M000

Preferred types

1) 120 Hz conversion factor of ripple current: $I_{\text{~}}(120 \text{ Hz}) = 1,03 \cdot I_{\text{~}}(100 \text{ Hz})$

2) Ordering code for standard terminals (6,3 mm).

To determine the ordering code for short terminals (4,5 mm) and 3 terminals (4,5 mm) see page 248.

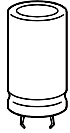

B43504

Compact – 105 °C

Useful life

depending on ambient temperature T_A under ripple current operating conditions¹⁾

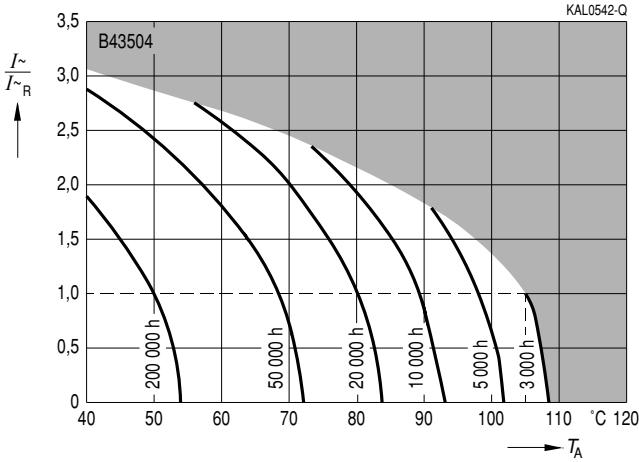

Frequency factor of permissible ripple current I_{\sim} versus frequency f

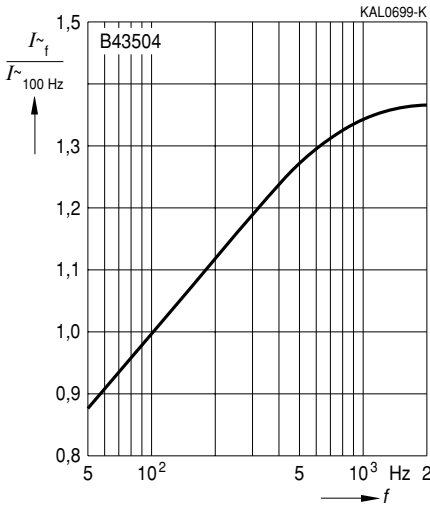

1) Refer to page 40 for an explanation on how to interpret the useful life graphs.

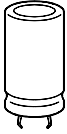

B43504

Compact – 105 °C

Frequency characteristics of ESR

Typical behavior

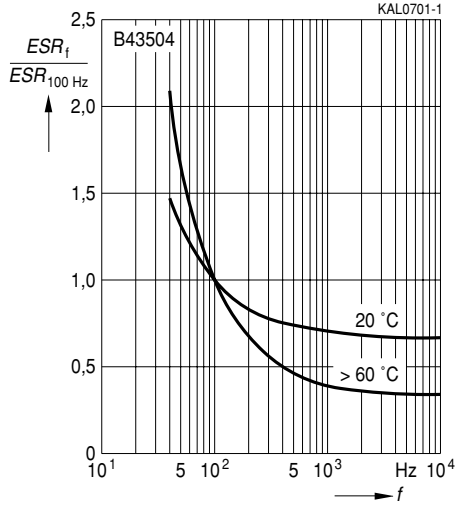

Impedance Z

versus frequency f

Typical behavior at 20 °C

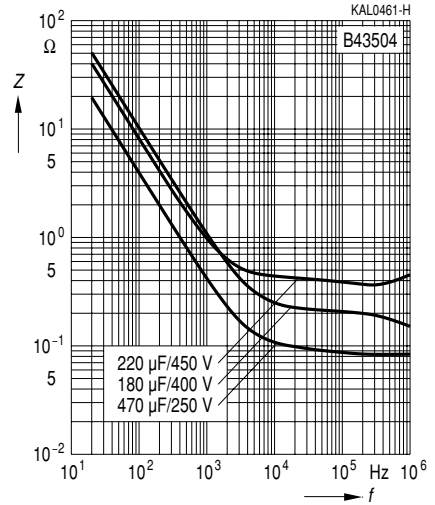

Herausgegeben von EPCOS AG

Unternehmenskommunikation, Postfach 80 17 09, 81617 München, DEUTSCHLAND

☎ ++49 89 636 09, FAX (0 89) 636-2 26 89

© EPCOS AG 2002. Vervielfältigung, Veröffentlichung, Verbreitung und Verwertung dieser Broschüre und ihres Inhalts ohne ausdrückliche Genehmigung der EPCOS AG nicht gestattet.

Bestellungen unterliegen den vom ZVEI empfohlenen Allgemeinen Lieferbedingungen für Erzeugnisse und Leistungen der Elektroindustrie, soweit nichts anderes vereinbart wird.

Diese Broschüre ersetzt die vorige Ausgabe.

Fragen über Technik, Preise und Liefermöglichkeiten richten Sie bitte an den Ihnen nächstgelegenen Vertrieb der EPCOS AG oder an unsere Vertriebsgesellschaften im Ausland. Bauelemente können aufgrund technischer Erfordernisse Gefahrstoffe enthalten. Auskünfte darüber bitten wir unter Angabe des betreffenden Typs ebenfalls über die zuständige Vertriebsgesellschaft einzuholen.

Published by EPCOS AG

Corporate Communications, P.O. Box 80 17 09, 81617 Munich, GERMANY

☎ ++49 89 636 09, FAX (0 89) 636-2 26 89

© EPCOS AG 2002. Reproduction, publication and dissemination of this brochure and the information contained therein without EPCOS' prior express consent is prohibited.

Purchase orders are subject to the General Conditions for the Supply of Products and Services of the Electrical and Electronics Industry recommended by the ZVEI (German Electrical and Electronic Manufacturers' Association), unless otherwise agreed.

This brochure replaces the previous edition.

For questions on technology, prices and delivery please contact the Sales Offices of EPCOS AG or the international Representatives.

Due to technical requirements components may contain dangerous substances. For information on the type in question please also contact one of our Sales Offices.