

0.5A SURFACE MOUNT GLASS PASSIVATED BRIDGE RECTIFIER

Features

- Glass Passivated Die Construction
- Low Forward Voltage Drop
- High Current Capability
- High Surge Current Capability
- Designed for Surface Mount Application
- Plastic Material – UL Flammability 94V-O
-  Recognized File # E157705

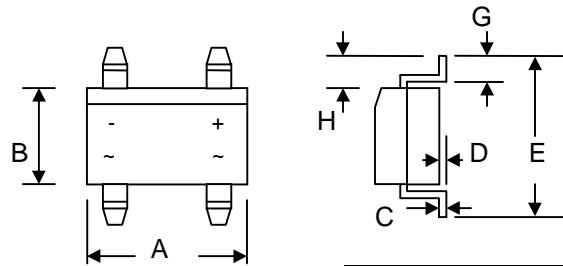

Mechanical Data

- Case: MB-S, Molded Plastic
- Terminals: Plated Leads Solderable per MIL-STD-202, Method 208
- Polarity: As Marked on Case
- Weight: 0.22 grams (approx.)
- Mounting Position: Any
- Marking: Type Number
- **Lead Free: For RoHS / Lead Free Version, Add "-LF" Suffix to Part Number, See Page 4**

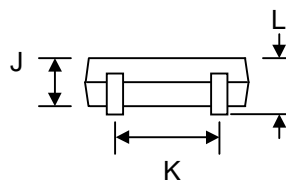

MB-S		
Dim	Min	Max
A	4.50	4.90
B	3.80	4.20
C	0.15	0.35
D	—	0.20
E	—	7.00
G	0.70	1.10
H	1.30	1.70
J	2.30	2.70
K	2.30	2.70
L	—	3.00
All Dimensions in mm		

Maximum Ratings and Electrical Characteristics @T_A=25°C unless otherwise specified

Single Phase, half wave, 60Hz, resistive or inductive load.
For capacitive load, derate current by 20%.

Characteristic	Symbol	B1S	B2S	B4S	B6S	B8S	B10S	Unit
Peak Repetitive Reverse Voltage	V _{RRM}	100	200	400	600	800	1000	V
Working Peak Reverse Voltage	V _{RWM}							
DC Blocking Voltage	V _R							
RMS Reverse Voltage	V _{R(RMS)}	70	140	280	420	560	700	V
Average Rectified Output Current (Note 1) @T _A = 40°C	I _O	0.5						A
Average Rectified Output Current (Note 2) @T _A = 40°C		0.8						
Non-Repetitive Peak Forward Surge Current 8.3ms Single half sine-wave superimposed on rated load (JEDEC Method)	I _{FSM}	30						A
I ² t Rating for Fusing (t < 8.3ms)	I ² t	5.0						A ² s
Forward Voltage per element @I _F = 0.5A	V _{FM}	1.0						V
Peak Reverse Current @T _A = 25°C	I _{RM}	5.0						μA
At Rated DC Blocking Voltage @T _A = 125°C		500						
Typical Junction Capacitance per leg (Note 3)	C _j	25						pF
Typical Thermal Resistance per leg (Note 1)	R _{θJA} R _{θJL}	85 20						°C/W
Operating and Storage Temperature Range	T _j , T _{STG}	-55 to +150						°C

Note: 1. Mounted on glass epoxy PC board with 1.3mm² solder pad.
2. Mounted on aluminum substrate PC board with 1.3mm² solder pad.
3. Measured at 1.0 MHz and applied reverse voltage of 4.0V D.C.

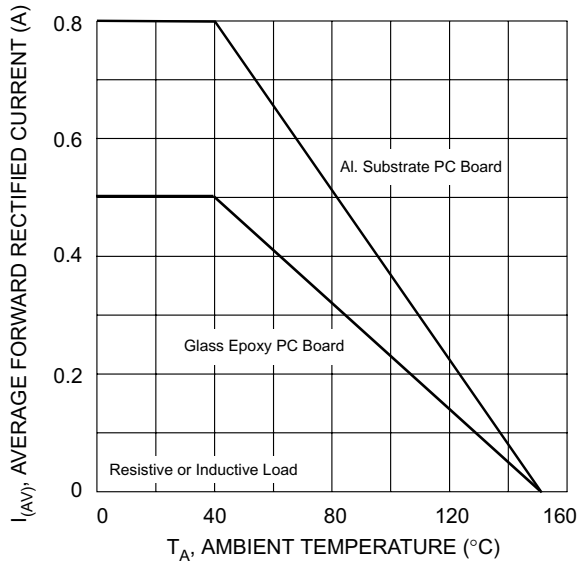

Fig. 1 Output Current Derating Curve

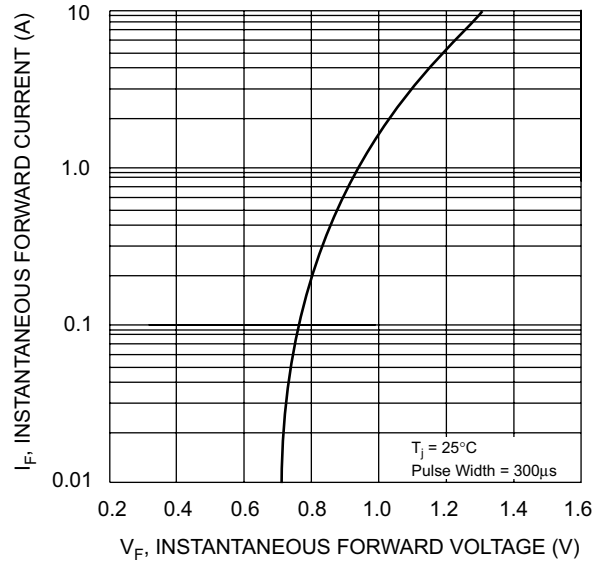

Fig. 2 Typical Forward Characteristics (per leg)

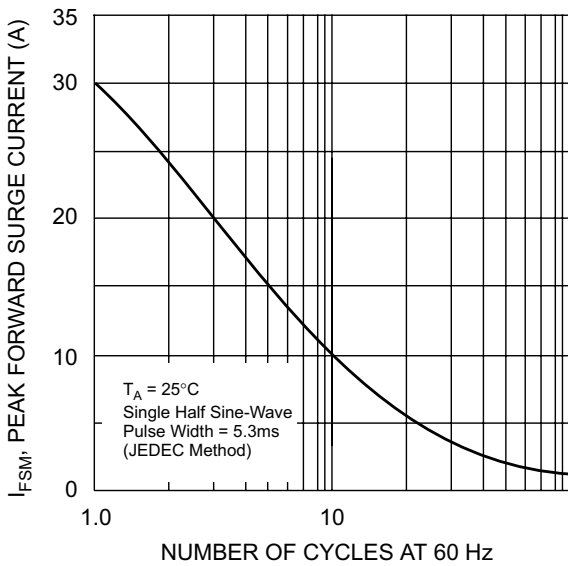

Fig. 3 Maximum Peak Forward Surge Current (per leg)

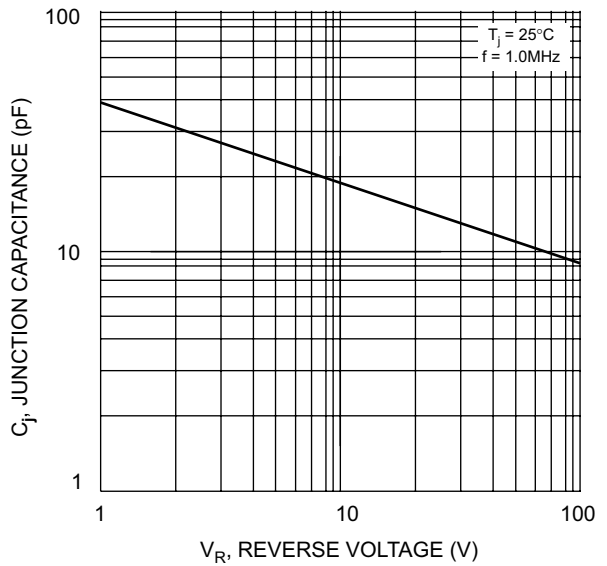

Fig. 4 Typical Junction Capacitance

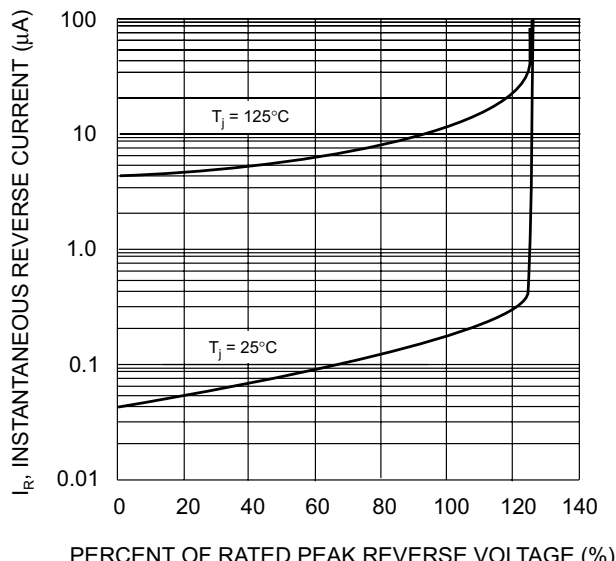
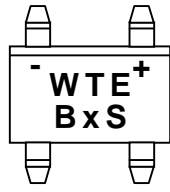

Fig. 5 Typical Reverse Characteristics (per element)

MARKING INFORMATION



WTE = Manufacturer's Logo
 BxS = Device Number
 x = 1, 2, 4, 6, 8 or 10
 Polarity = As Marked on Body

RECOMMENDED FOOTPRINT

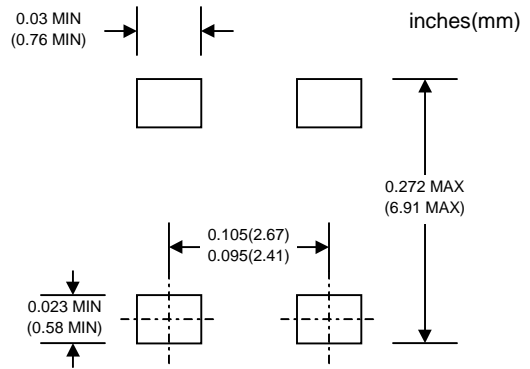

PACKAGING INFORMATION

TAPE & REEL

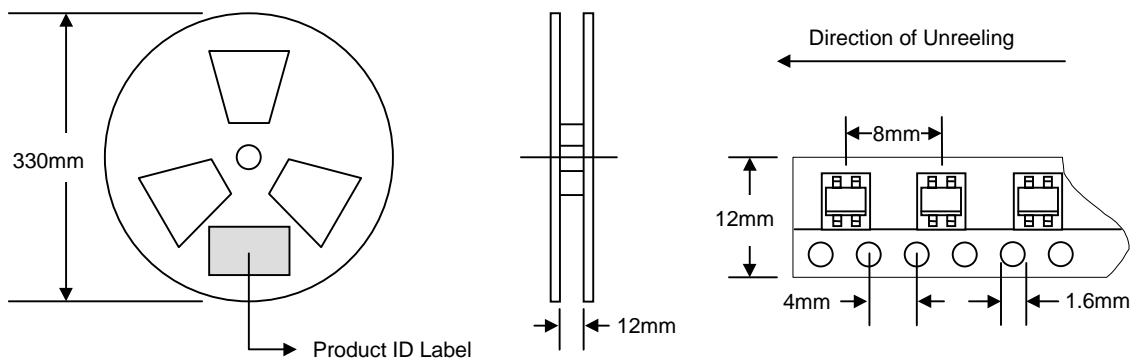

Reel Diameter (mm)	Quantity (PCS)	Inner Box Size L x W x H (mm)	Quantity (PCS)	Carton Size L x W x H (mm)	Quantity (PCS)	Approx. Gross Weight (KG)
330	3,000	340 x 337 x 45	6,000	370 x 370 x 420	48,000	15.0

Note: 1. Paper reel, white or gray color.
 2. Components are packed in accordance with EIA standard 481-1 and 481-2.

ORDERING INFORMATION

Product No.	Package Type	Shipping Quantity
B1S-T3	Mini Bridge SMD	3000/Tape & Reel
B2S-T3	Mini Bridge SMD	3000/Tape & Reel
B4S-T3	Mini Bridge SMD	3000/Tape & Reel
B6S-T3	Mini Bridge SMD	3000/Tape & Reel
B8S-T3	Mini Bridge SMD	3000/Tape & Reel
B10S-T3	Mini Bridge SMD	3000/Tape & Reel

1. Shipping quantity given is for minimum packing quantity only. For minimum order quantity, please consult the Sales Department.
2. **To order Lead Free version (with Lead Free finish), add "-LF" suffix to part number above. For example, B1S-T3-LF.**

Won-Top Electronics Co., Ltd (WTE) has checked all information carefully and believes it to be correct and accurate. However, WTE cannot assume any responsibility for inaccuracies. Furthermore, this information does not give the purchaser of semiconductor devices any license under patent rights to manufacturer. WTE reserves the right to change any or all information herein without further notice.

WARNING: DO NOT USE IN LIFE SUPPORT EQUIPMENT. WTE power semiconductor products are not authorized for use as critical components in life support devices or systems without the express written approval.

Won-Top Electronics Co., Ltd.

No. 44 Yu Kang North 3rd Road, Chine Chen Dist., Kaohsiung, Taiwan

Phone: 886-7-822-5408 or 886-7-822-5410

Fax: 886-7-822-5417

Email: sales@wontop.com

Internet: <http://www.wontop.com>

We power your everyday.