

## Boost chopper MOSFET Power Module

$V_{DSS} = 1000V$   
 $R_{DSon} = 90m\Omega$  typ @  $T_j = 25^\circ C$   
 $I_D = 78A$  @  $T_c = 25^\circ C$

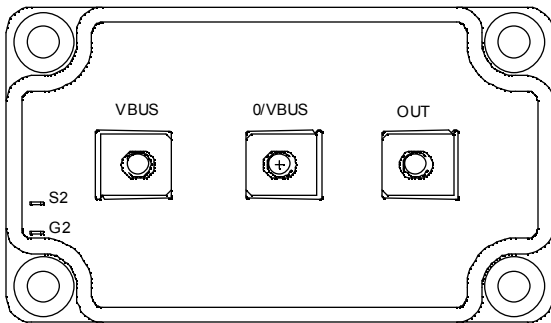
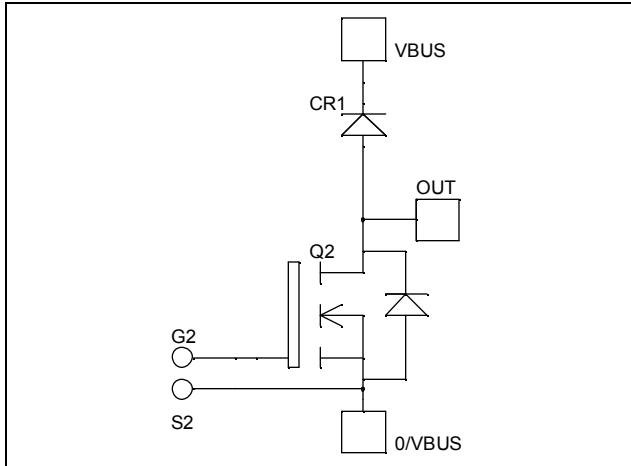

### Application

- AC and DC motor control
- Switched Mode Power Supplies
- Power Factor Correction

### Features

- Power MOS 7<sup>®</sup> MOSFETs
  - Low  $R_{DSon}$
  - Low input and Miller capacitance
  - Low gate charge
  - Avalanche energy rated
  - Very rugged
- Kelvin source for easy drive
- Very low stray inductance
  - Symmetrical design
  - M5 power connectors
- High level of integration

### Benefits

- Outstanding performance at high frequency operation
- Direct mounting to heatsink (isolated package)
- Low junction to case thermal resistance
- Low profile
- RoHS Compliant

### Absolute maximum ratings

Symbol	Parameter	Max ratings	Unit
$V_{DSS}$	Drain - Source Breakdown Voltage	1000	V
$I_D$	Continuous Drain Current	$T_c = 25^\circ C$	78
		$T_c = 80^\circ C$	59
$I_{DM}$	Pulsed Drain current	312	A
$V_{GS}$	Gate - Source Voltage	$\pm 30$	V
$R_{DSon}$	Drain - Source ON Resistance	105	$m\Omega$
$P_D$	Maximum Power Dissipation	$T_c = 25^\circ C$	1250
$I_{AR}$	Avalanche current (repetitive and non repetitive)	25	A
$E_{AR}$	Repetitive Avalanche Energy	50	mJ
$E_{AS}$	Single Pulse Avalanche Energy	3000	

 **CAUTION:** These Devices are sensitive to Electrostatic Discharge. Proper Handling Procedures Should Be Followed. See application note APT0502 on [www.microsemi.com](http://www.microsemi.com)

All ratings @  $T_j = 25^\circ\text{C}$  unless otherwise specified

**Electrical Characteristics**

Symbol	Characteristic	Test Conditions	Min	Typ	Max	Unit
$I_{DSS}$	Zero Gate Voltage Drain Current	$V_{GS} = 0\text{V}, V_{DS} = 1000\text{V}$			400	$\mu\text{A}$
		$V_{GS} = 0\text{V}, V_{DS} = 800\text{V}$			2000	
$R_{DS(on)}$	Drain – Source on Resistance	$V_{GS} = 10\text{V}, I_D = 39\text{A}$		90	105	$\text{m}\Omega$
$V_{GS(th)}$	Gate Threshold Voltage	$V_{GS} = V_{DS}, I_D = 10\text{mA}$	3		5	V
$I_{GSS}$	Gate – Source Leakage Current	$V_{GS} = \pm 30\text{V}, V_{DS} = 0\text{V}$			$\pm 250$	nA

**Dynamic Characteristics**

Symbol	Characteristic	Test Conditions	Min	Typ	Max	Unit
$C_{iss}$	Input Capacitance	$V_{GS} = 0\text{V}$		20.7		nF
$C_{oss}$	Output Capacitance	$V_{DS} = 25\text{V}$		3.5		
$C_{rss}$	Reverse Transfer Capacitance	$f = 1\text{MHz}$		0.64		
$Q_g$	Total gate Charge	$V_{GS} = 10\text{V}$		744		nC
$Q_{gs}$	Gate – Source Charge	$V_{Bus} = 500\text{V}$		96		
$Q_{gd}$	Gate – Drain Charge	$I_D = 78\text{A}$		488		
$T_{d(on)}$	Turn-on Delay Time	<b>Inductive switching @ <math>125^\circ\text{C}</math></b> $V_{GS} = 15\text{V}$ $V_{Bus} = 670\text{V}$ $I_D = 78\text{A}$ $R_G = 1.2\Omega$		18		ns
$T_r$	Rise Time			12		
$T_{d(off)}$	Turn-off Delay Time			155		
$T_f$	Fall Time			40		
$E_{on}$	Turn-on Switching Energy	<b>Inductive switching @ <math>25^\circ\text{C}</math></b> $V_{GS} = 15\text{V}, V_{Bus} = 670\text{V}$ $I_D = 78\text{A}, R_G = 1.2\Omega$		3.6		mJ
$E_{off}$	Turn-off Switching Energy			2.5		
$E_{on}$	Turn-on Switching Energy	<b>Inductive switching @ <math>125^\circ\text{C}</math></b> $V_{GS} = 15\text{V}, V_{Bus} = 670\text{V}$ $I_D = 78\text{A}, R_G = 1.2\Omega$		5.7		mJ
$E_{off}$	Turn-off Switching Energy			3.1		

**Chopper diode ratings and characteristics**

Symbol	Characteristic	Test Conditions	Min	Typ	Max	Unit
$V_{RRM}$	Maximum Peak Repetitive Reverse Voltage		1000			V
$I_{RM}$	Maximum Reverse Leakage Current	$V_R = 1000\text{V}$	$T_j = 25^\circ\text{C}$		250	$\mu\text{A}$
			$T_j = 125^\circ\text{C}$		500	
$I_F$	DC Forward Current	$T_c = 70^\circ\text{C}$		100		A
$V_F$	Diode Forward Voltage	$I_F = 100\text{A}$		1.9	2.5	V
		$I_F = 200\text{A}$		2.2		
		$I_F = 100\text{A}$	$T_j = 125^\circ\text{C}$	1.7		
$t_{rr}$	Reverse Recovery Time	$I_F = 100\text{A}$ $V_R = 670\text{V}$ $di/dt = 200\text{A}/\mu\text{s}$	$T_j = 25^\circ\text{C}$		300	ns
			$T_j = 125^\circ\text{C}$		360	
$Q_{rr}$	Reverse Recovery Charge	$I_F = 100\text{A}$ $V_R = 670\text{V}$ $di/dt = 200\text{A}/\mu\text{s}$	$T_j = 25^\circ\text{C}$		800	nC
			$T_j = 125^\circ\text{C}$		4050	

## Thermal and package characteristics

Symbol Characteristic

			Min	Typ	Max	Unit
R <sub>thJC</sub>	Junction to Case Thermal Resistance	Transistor			0.1	°C/W
		Diode			0.55	
V <sub>ISOL</sub>	RMS Isolation Voltage, any terminal to case t = 1 min, I <sub>isol</sub> < 1 mA, 50/60Hz		2500			V
T <sub>J</sub>	Operating junction temperature range		-40		150	°C
T <sub>STG</sub>	Storage Temperature Range		-40		125	
T <sub>C</sub>	Operating Case Temperature		-40		100	
Torque	Mounting torque	To heatsink	M6	3	5	N.m
		For terminals	M5	2	3.5	
Wt	Package Weight				280	g

## SP6 Package outline (dimensions in mm)

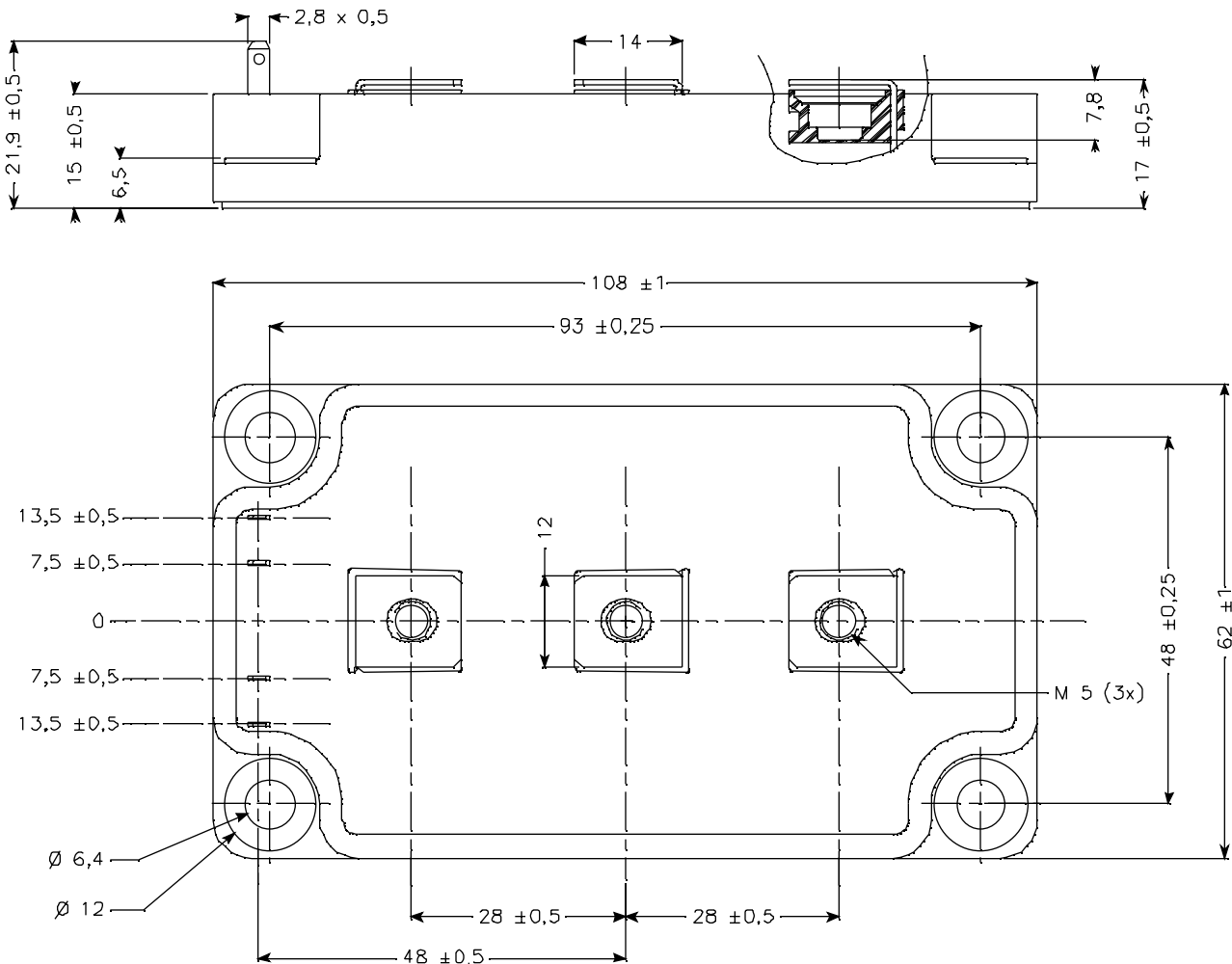

See application note APT0601 - Mounting Instructions for SP6 Power Modules on [www.microsemi.com](http://www.microsemi.com)

## Typical Performance Curve

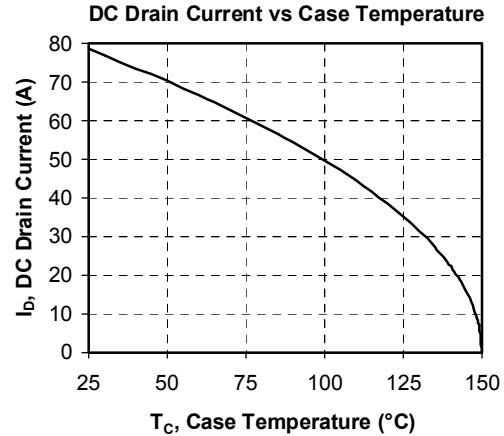
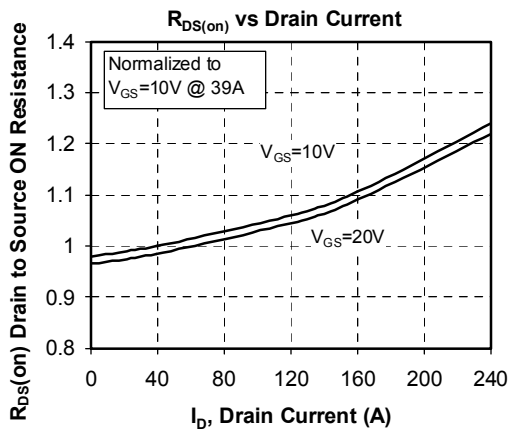
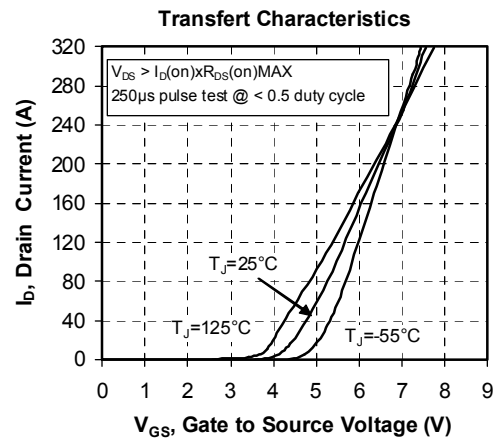
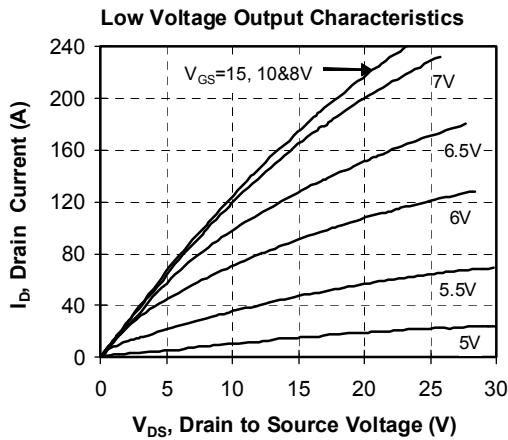
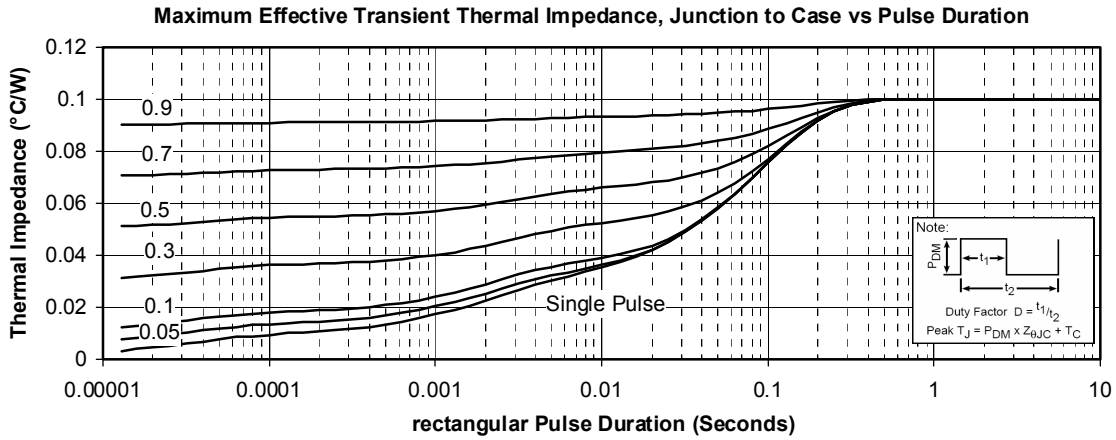

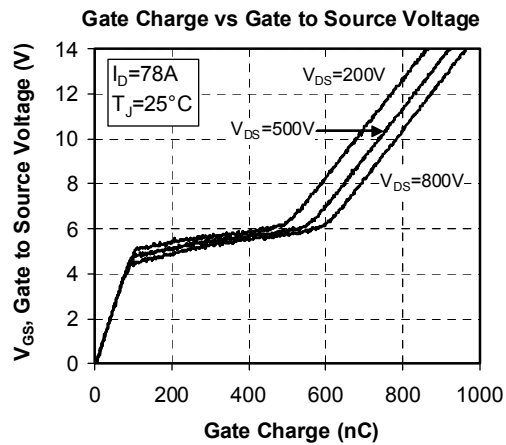
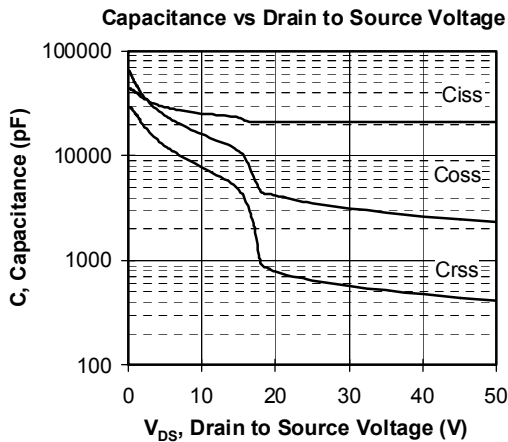
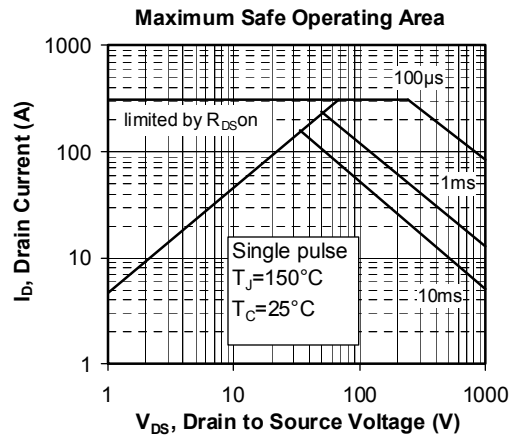
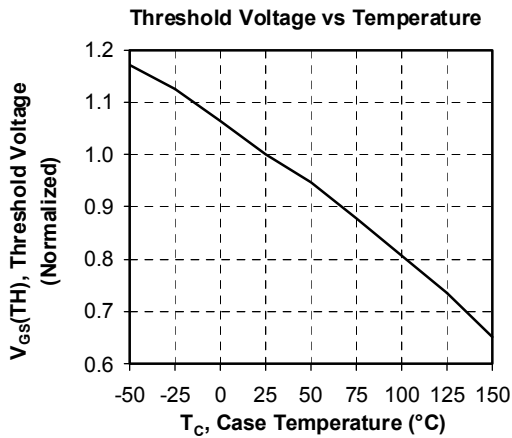
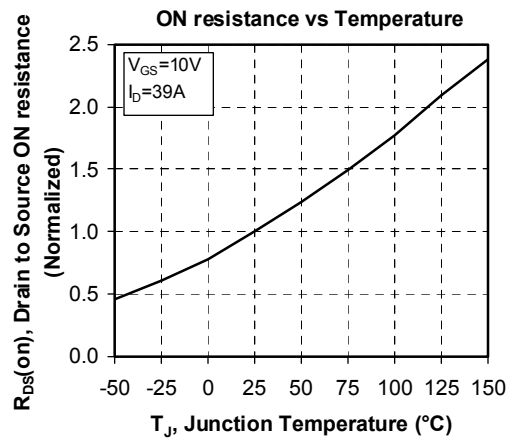
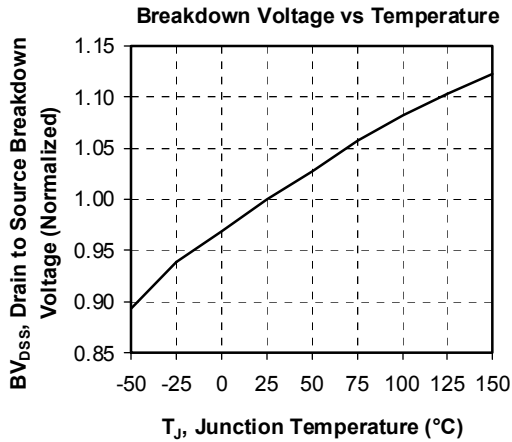

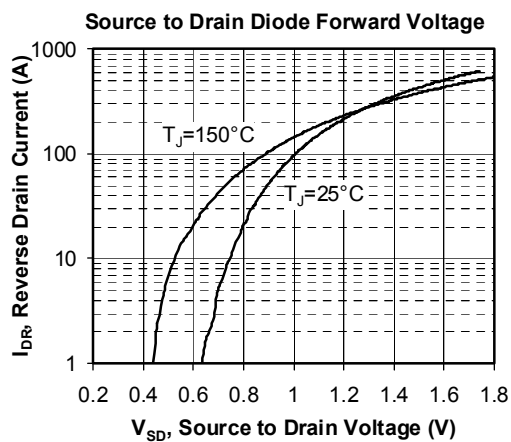
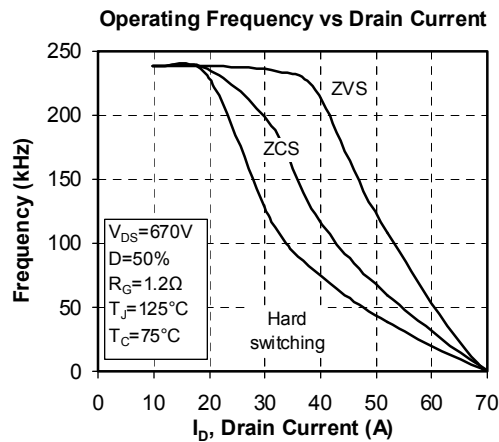
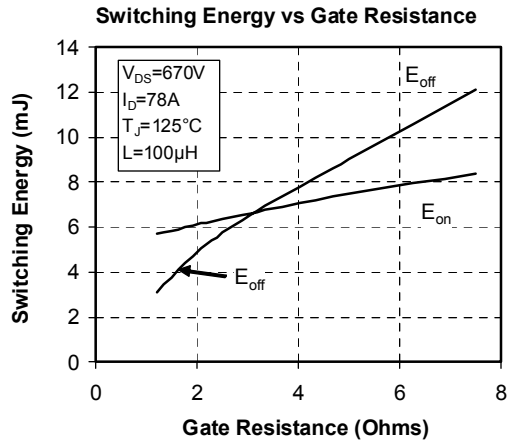
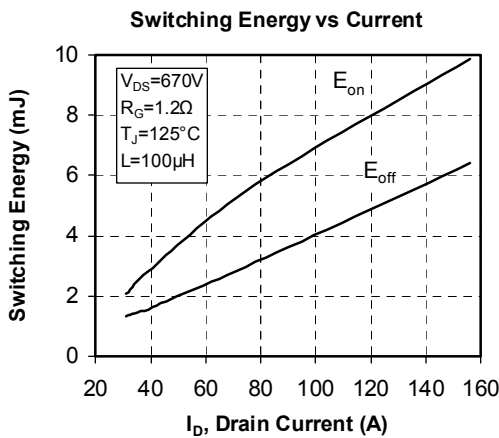
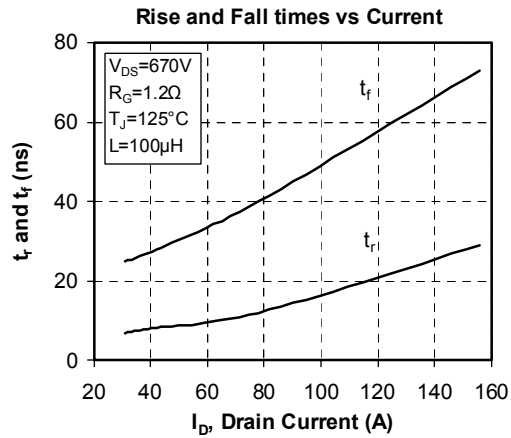
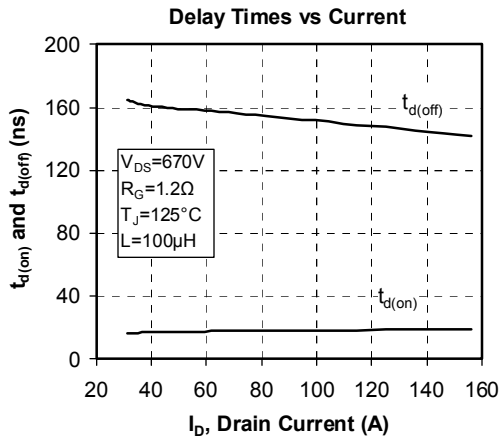

Microsemi reserves the right to change, without notice, the specifications and information contained herein

Microsemi's products are covered by one or more of U.S. patents 4,895,810 5,045,903 5,089,434 5,182,234 5,019,522 5,262,336 6,503,786 5,256,583 4,748,103 5,283,202 5,231,474 5,434,095 5,528,058 and foreign patents. U.S. and Foreign patents pending. All Rights Reserved.