

Triple phase leg NPT IGBT Power Module

$V_{CES} = 1200V$
 $I_C = 50A @ T_c = 80^\circ C$

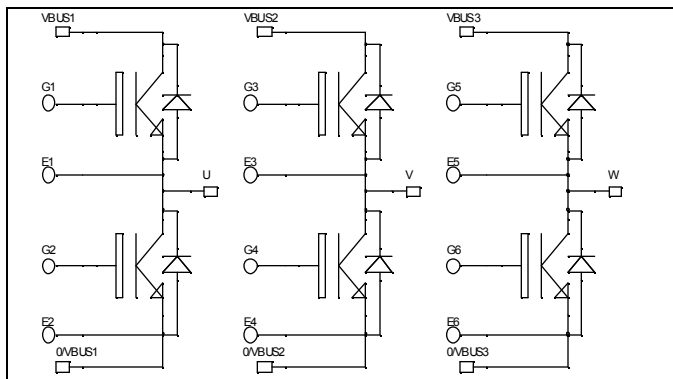

Application

- Welding converters
- Switched Mode Power Supplies
- Uninterruptible Power Supplies
- Motor control

Features

- Non Punch Through (NPT) FAST IGBT
 - Low voltage drop
 - Low tail current
 - Switching frequency up to 50 kHz
 - Soft recovery parallel diodes
 - Low diode VF
 - Low leakage current
 - Avalanche energy rated
 - RBSOA and SCSOA rated
- Kelvin emitter for easy drive
- Very low stray inductance
 - Symmetrical design
 - Lead frames for power connections
- High level of integration

Benefits

- Outstanding performance at high frequency operation
- Direct mounting to heatsink (isolated package)
- Low junction to case thermal resistance
- Solderable terminals both for power and signal for easy PCB mounting
- Very low (12mm) profile
- Easy paralleling due to positive TC of VCESat
- Each leg can be easily paralleled to achieve a phase leg of three times the current capability
- Module can be configured as a three phase bridge
- Module can be configured as a boost followed by a full bridge
- RoHS compliant

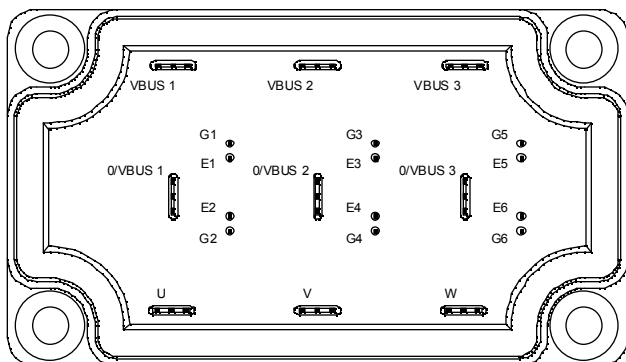

Absolute maximum ratings

Symbol	Parameter	Max ratings	Unit
V_{CES}	Collector - Emitter Breakdown Voltage	1200	V
I_C	Continuous Collector Current	$T_c = 25^\circ C$	75
		$T_c = 80^\circ C$	50
I_{CM}	Pulsed Collector Current	$T_c = 25^\circ C$	150
V_{GE}	Gate - Emitter Voltage	± 20	V
P_D	Maximum Power Dissipation	$T_c = 25^\circ C$	312
RBSOA	Reverse Bias Safe Operating Area	$T_j = 150^\circ C$	100A @ 1200V

CAUTION: These Devices are sensitive to Electrostatic Discharge. Proper Handling Procedures Should Be Followed. See application note APT0502 on www.microsemi.com

All ratings @ $T_j = 25^\circ\text{C}$ unless otherwise specified

Electrical Characteristics

Symbol	Characteristic	Test Conditions	Min	Typ	Max	Unit
I_{CES}	Zero Gate Voltage Collector Current	$V_{GE} = 0\text{V}$ $V_{CE} = 1200\text{V}$			250 500	μA
$V_{CE(sat)}$	Collector Emitter saturation Voltage	$V_{GE} = 15\text{V}$ $I_C = 50\text{A}$		3.2 4.0	3.7	V
$V_{GE(th)}$	Gate Threshold Voltage	$V_{GE} = V_{CE}, I_C = 1\text{mA}$	4.5		6.5	V
I_{GES}	Gate – Emitter Leakage Current	$V_{GE} = 20\text{V}, V_{CE} = 0\text{V}$			100	nA

Dynamic Characteristics

Symbol	Characteristic	Test Conditions	Min	Typ	Max	Unit
C_{ies}	Input Capacitance	$V_{GE} = 0\text{V}$		3450		pF
C_{oes}	Output Capacitance	$V_{CE} = 25\text{V}$		330		
C_{res}	Reverse Transfer Capacitance	$f = 1\text{MHz}$		220		
Q_g	Total gate Charge	$V_{GS} = 15\text{V}$		330		nC
Q_{ge}	Gate – Emitter Charge	$V_{Bus} = 600\text{V}$		35		
Q_{gc}	Gate – Collector Charge	$I_C = 50\text{A}$		200		
$T_{d(on)}$	Turn-on Delay Time	Inductive Switching (25°C)		35		ns
T_r	Rise Time	$V_{GE} = 15\text{V}$ $V_{Bus} = 600\text{V}$		65		
$T_{d(off)}$	Turn-off Delay Time	$I_C = 50\text{A}$		320		
T_f	Fall Time	$R_G = 5\ \Omega$		30		
$T_{d(on)}$	Turn-on Delay Time	Inductive Switching (125°C)		35		ns
T_r	Rise Time	$V_{GE} = \pm 15\text{V}$ $V_{Bus} = 600\text{V}$		65		
$T_{d(off)}$	Turn-off Delay Time	$I_C = 50\text{A}$		360		
T_f	Fall Time	$R_G = 5\ \Omega$		40		
E_{on}	Turn-on Switching Energy	$V_{GE} = \pm 15\text{V}$ $V_{Bus} = 600\text{V}$	$T_j = 125^\circ\text{C}$	6.9		mJ
E_{off}	Turn-off Switching Energy	$I_C = 50\text{A}$ $R_G = 5\ \Omega$	$T_j = 125^\circ\text{C}$	3.05		

Chopper diode ratings and characteristics

Symbol	Characteristic	Test Conditions	Min	Typ	Max	Unit
V_{RRM}	Maximum Peak Repetitive Reverse Voltage		1200			V
I_{RM}	Maximum Reverse Leakage Current	$V_R = 1200\text{V}$			250 500	μA
I_F	DC Forward Current			60		A
V_F	Diode Forward Voltage	$I_F = 60\text{A}$		2.0	2.5	V
		$I_F = 120\text{A}$		2.3		
		$I_F = 60\text{A}$ $T_j = 125^\circ\text{C}$		1.8		
t_{rr}	Reverse Recovery Time	$I_F = 60\text{A}$ $V_R = 800\text{V}$	$T_j = 25^\circ\text{C}$ $T_j = 125^\circ\text{C}$	400 470		ns
Q_{rr}	Reverse Recovery Charge	$di/dt = 200\text{A}/\mu\text{s}$	$T_j = 25^\circ\text{C}$ $T_j = 125^\circ\text{C}$	1200 4000		

Thermal and package characteristics

Symbol Characteristic

			Min	Typ	Max	Unit
R _{thJC}	Junction to Case Thermal Resistance	IGBT			0.4	°C/W
		Diode			0.9	
V _{ISOL}	RMS Isolation Voltage, any terminal to case t=1 min, I _{isol} <1mA, 50/60Hz		2500			V
T _J	Operating junction temperature range		-40		150	°C
T _{STG}	Storage Temperature Range		-40		125	
T _C	Operating Case Temperature		-40		100	
Torque	Mounting torque	To heatsink	M6	3	5	N.m
Wt	Package Weight				250	g

SP6-P Package outline (dimensions in mm)

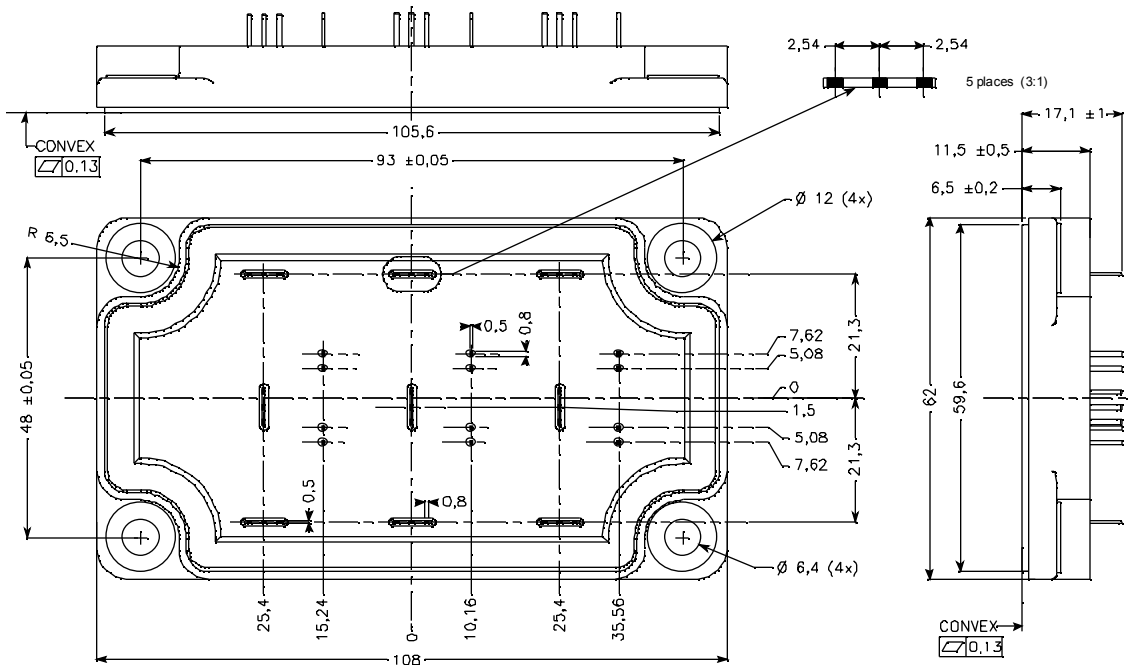

See application note 1902 - Mounting Instructions for SP6-P (12mm) Power Modules on www.microsemi.com

Typical Performance Curve

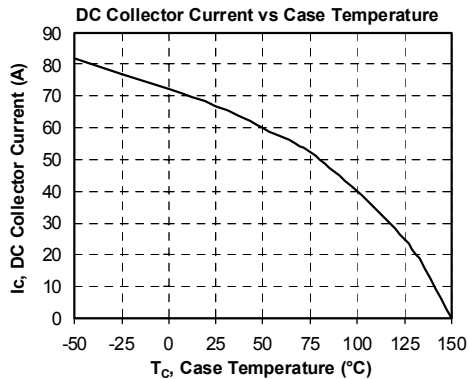
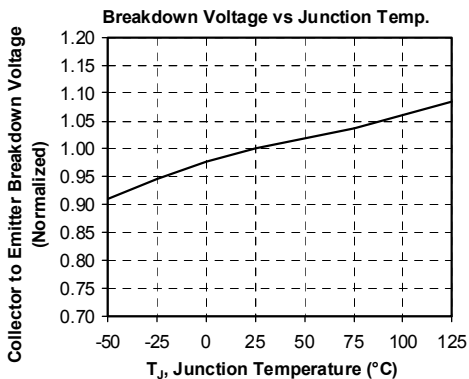
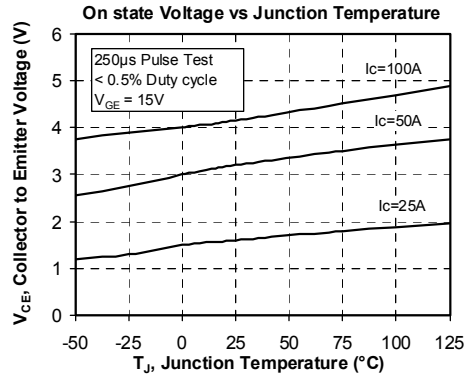
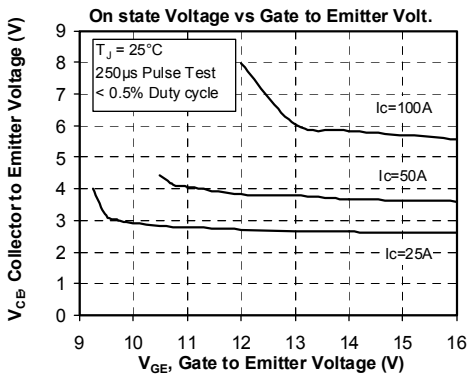
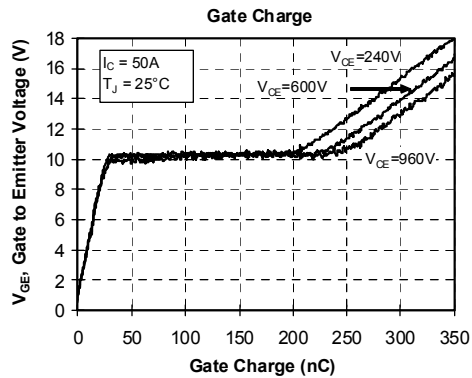
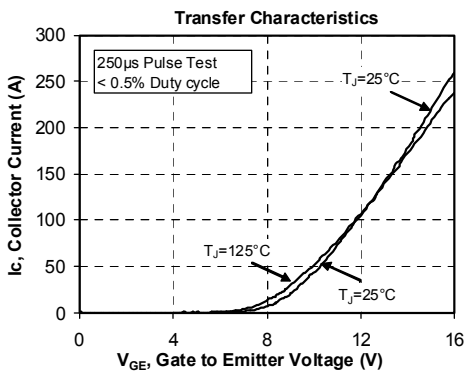
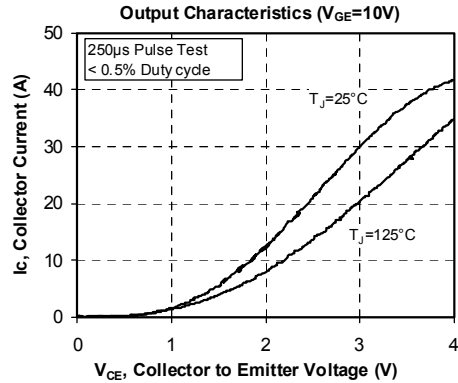
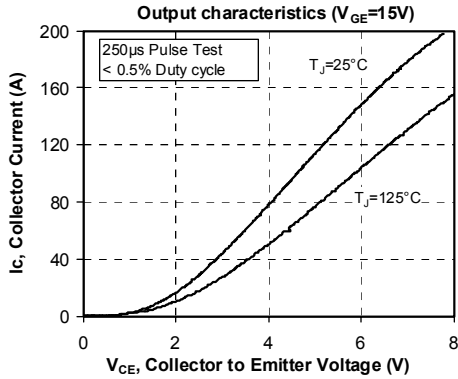

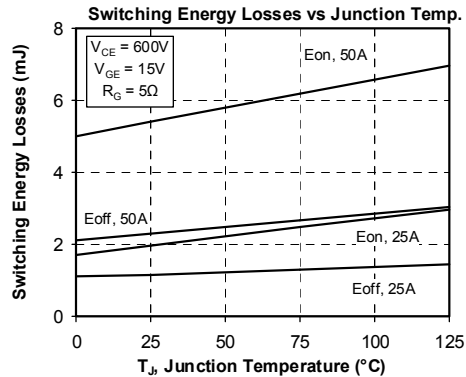
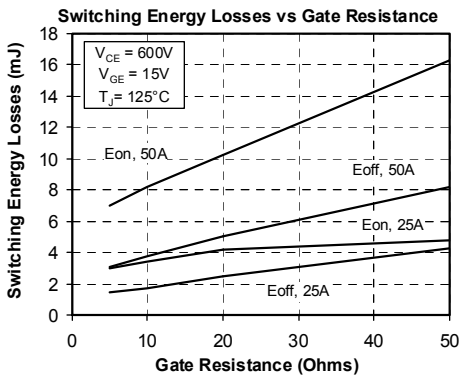
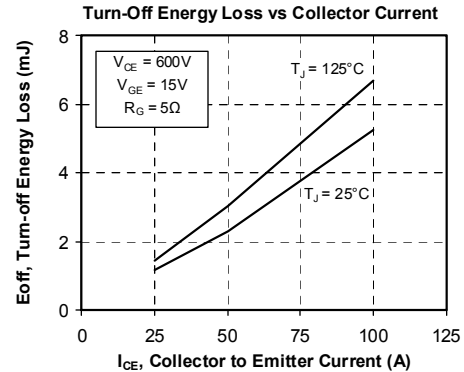
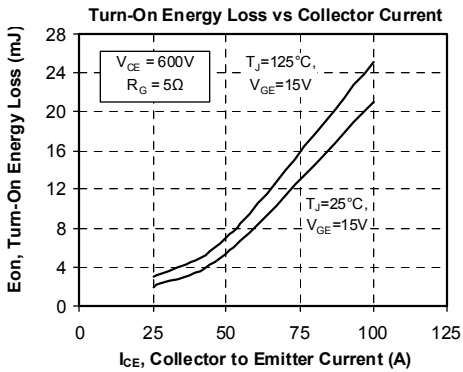
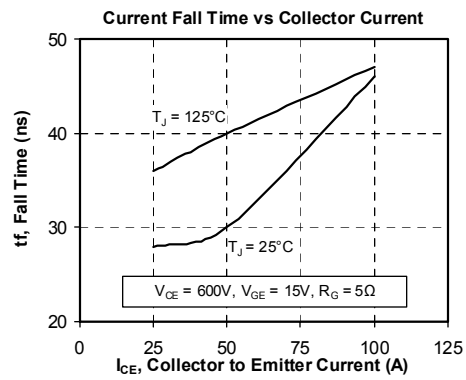
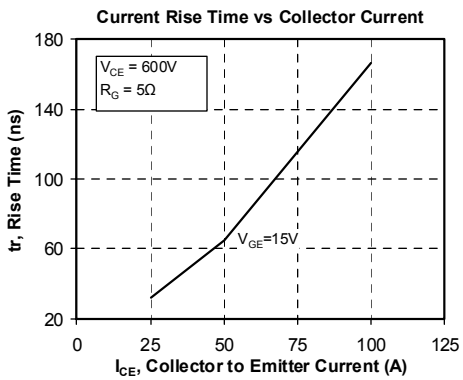
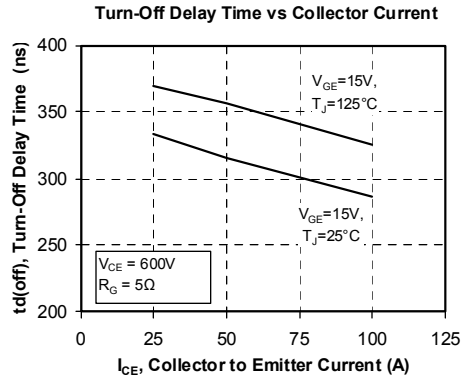
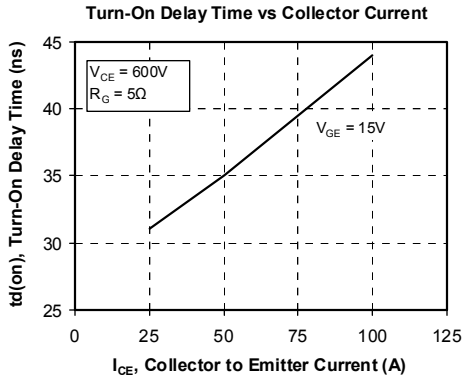

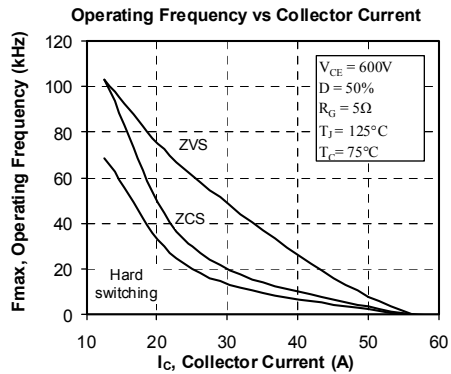
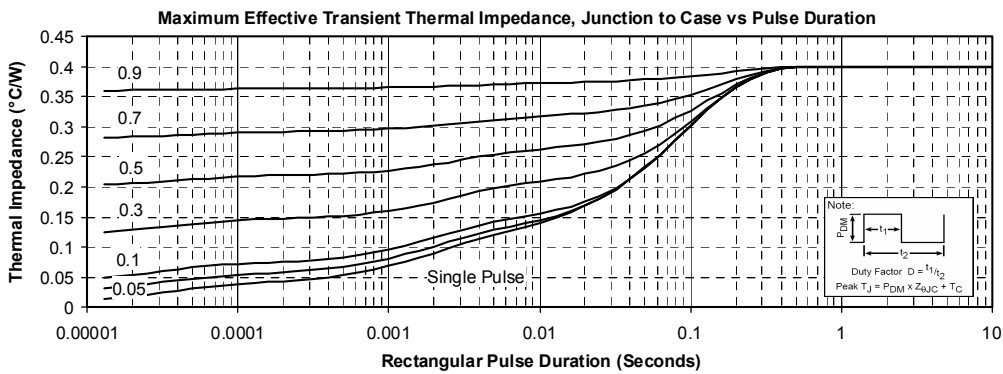
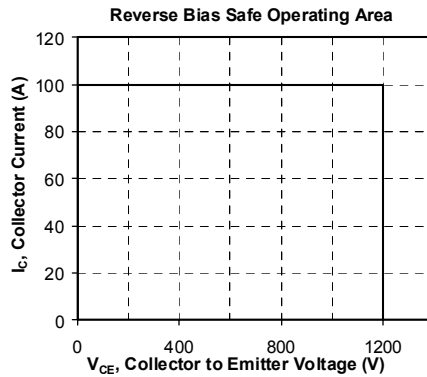
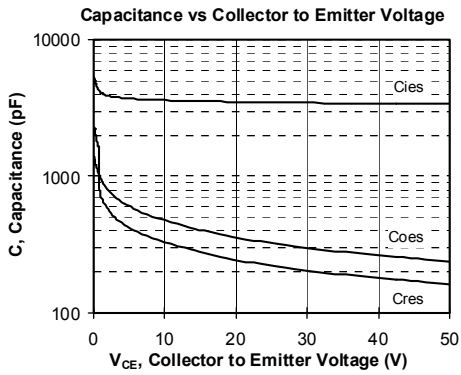

Microsemi reserves the right to change, without notice, the specifications and information contained herein

Microsemi's products are covered by one or more of U.S. patents 4,895,810 5,045,903 5,089,434 5,182,234 5,019,522 5,262,336 6,503,786 5,256,583 4,748,103 5,283,202 5,231,474 5,434,095 5,528,058 and foreign patents. U.S. and Foreign patents pending. All Rights Reserved.