

**Full - Bridge
Series & SiC parallel diodes
Super Junction
MOSFET Power Module**

**$V_{DSS} = 800V$
 $R_{DSon} = 290m\Omega$ max @ $T_j = 25^\circ C$
 $I_D = 15A$ @ $T_c = 25^\circ C$**

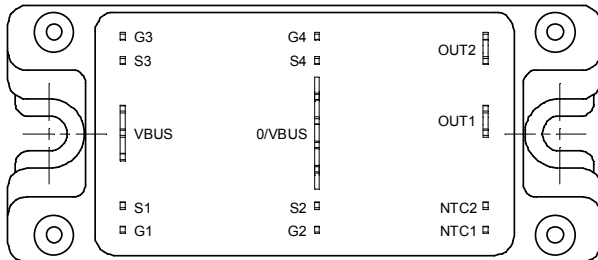
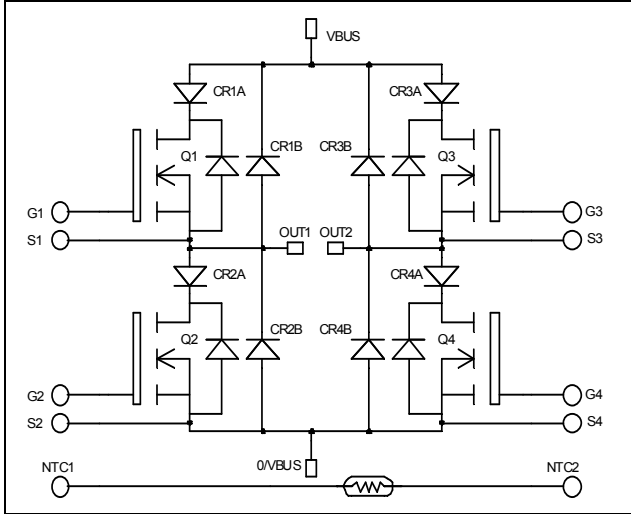

Application

- Motor control
- Switched Mode Power Supplies
- Uninterruptible Power Supplies

Features

- **COOLMOS** Power Semiconductors
 - Ultra low R_{DSon}
 - Low Miller capacitance
 - Ultra low gate charge
 - Avalanche energy rated
- **Parallel SiC Schottky Diode**
 - Zero reverse recovery
 - Zero forward recovery
 - Temperature Independent switching behavior
 - Positive temperature coefficient on VF
- Kelvin source for easy drive
- Very low stray inductance
 - Symmetrical design
 - Lead frames for power connections
- Internal thermistor for temperature monitoring
- High level of integration

Benefits

- Outstanding performance at high frequency operation
- Direct mounting to heatsink (isolated package)
- Low junction to case thermal resistance
- Solderable terminals both for power and signal for easy PCB mounting
- Low profile

Absolute maximum ratings

Symbol	Parameter	Max ratings	Unit
V_{DSS}	Drain - Source Breakdown Voltage	800	V
I_D	Continuous Drain Current	$T_c = 25^\circ C$	15
		$T_c = 80^\circ C$	11
I_{DM}	Pulsed Drain current	60	A
V_{GS}	Gate - Source Voltage	± 30	V
R_{DSon}	Drain - Source ON Resistance	290	$m\Omega$
P_D	Maximum Power Dissipation	$T_c = 25^\circ C$	156
I_{AR}	Avalanche current (repetitive and non repetitive)	24	A
E_{AR}	Repetitive Avalanche Energy	0.5	mJ
E_{AS}	Single Pulse Avalanche Energy	670	

CAUTION: These Devices are sensitive to Electrostatic Discharge. Proper Handling Procedures Should Be Followed.

All ratings @ $T_j = 25^\circ\text{C}$ unless otherwise specified

Electrical Characteristics

Symbol	Characteristic	Test Conditions	Min	Typ	Max	Unit
BV_{DSS}	Drain - Source Breakdown Voltage	$V_{GS} = 0V, I_D = 250\mu A$	800			V
I_{DSS}	Zero Gate Voltage Drain Current	$V_{GS} = 0V, V_{DS} = 800V, T_j = 25^\circ\text{C}$			25	μA
		$V_{GS} = 0V, V_{DS} = 800V, T_j = 125^\circ\text{C}$			250	
$R_{DS(on)}$	Drain - Source on Resistance	$V_{GS} = 10V, I_D = 7.5A$			290	$m\Omega$
$V_{GS(th)}$	Gate Threshold Voltage	$V_{GS} = V_{DS}, I_D = 1mA$	2.1	3	3.9	V
I_{GSS}	Gate - Source Leakage Current	$V_{GS} = \pm 20V, V_{DS} = 0V$			± 100	nA

Dynamic Characteristics

Symbol	Characteristic	Test Conditions	Min	Typ	Max	Unit
C_{iss}	Input Capacitance	$V_{GS} = 0V$		2254		pF
C_{oss}	Output Capacitance	$V_{DS} = 25V$		1046		
C_{rss}	Reverse Transfer Capacitance	$f = 1MHz$		54		
Q_g	Total gate Charge	$V_{GS} = 10V$		91		nC
Q_{gs}	Gate - Source Charge	$V_{Bus} = 400V$		12		
Q_{gd}	Gate - Drain Charge	$I_D = 15A$		46		
$T_{d(on)}$	Turn-on Delay Time	Inductive switching @125°C $V_{GS} = 15V$ $V_{Bus} = 533V$ $I_D = 15A$ $R_G = 5\Omega$		10		ns
T_r	Rise Time			13		
$T_{d(off)}$	Turn-off Delay Time			83		
T_f	Fall Time			35		
E_{on}	Turn-on Switching Energy	Inductive switching @ 25°C $V_{GS} = 15V, V_{Bus} = 533V$ $I_D = 15A, R_G = 5\Omega$		146		μJ
E_{off}	Turn-off Switching Energy ❶			139		
E_{on}	Turn-on Switching Energy	Inductive switching @ 125°C $V_{GS} = 15V, V_{Bus} = 533V$ $I_D = 15A, R_G = 5\Omega$		255		μJ
E_{off}	Turn-off Switching Energy ❶			171		

Series diode ratings and characteristics

Symbol	Characteristic	Test Conditions	Min	Typ	Max	Unit
$I_{F(AV)}$	Maximum Average Forward Current	50% duty cycle, $T_c = 85^\circ\text{C}$		30		A
V_F	Diode Forward Voltage	$I_F = 30A$		1.1	1.15	V
		$I_F = 60A$		1.4		
		$I_F = 30A, T_j = 125^\circ\text{C}$		0.9		
t_{rr}	Reverse Recovery Time	$I_F = 30A, V_R = 133V, di/dt = 200A/\mu s, T_j = 25^\circ\text{C}$		24		ns
		$T_j = 125^\circ\text{C}$		48		
Q_{rr}	Reverse Recovery Charge	$I_F = 30A, V_R = 133V, di/dt = 200A/\mu s, T_j = 25^\circ\text{C}$		33		nC
		$T_j = 125^\circ\text{C}$		150		

❶ In accordance with JEDEC standard JESD24-1.

Parallel diode ratings and characteristics

Symbol	Characteristic	Test Conditions		Min	Typ	Max	Unit
I _{F(AV)}	Maximum Average Forward Current	50% duty cycle	T _c = 125°C		5		A
V _F	Diode Forward Voltage	I _F = 5A	T _j = 25°C		1.6	1.8	V
			T _j = 175°C		2.6	3.0	
Q _C	Total Capacitive Charge	I _F = 5A, V _R = 600V di/dt = 500A/μs			14		nC
Q	Total Capacitance	f = 1MHz, V _R = 200V			45		pF
		f = 1MHz, V _R = 400V			33		

Thermal and package characteristics

Symbol	Characteristic		Min	Typ	Max	Unit
R _{thJC}	Junction to Case	Transistor			0.8	°C/W
		Series diode			1.2	
		Parallel diode			2.5	
V _{ISOL}	RMS Isolation Voltage, any terminal to case t=1 min, I _{isol} <1mA, 50/60Hz		2500			V
T _J	Operating junction temperature range		-40		150	°C
T _{STG}	Storage Temperature Range		-40		125	
T _C	Operating Case Temperature		-40		100	
Torque	Mounting torque	To Heatsink	M5		4.7	N.m
Wt	Package Weight				160	g

Temperature sensor NTC

Symbol	Characteristic	Min	Typ	Max	Unit
R ₂₅	Resistance @ 25°C		68		kΩ
B _{25/85}	T ₂₅ = 298.16 K		4080		K

$$R_T = \frac{R_{25}}{\exp \left[B_{25/85} \left(\frac{1}{T_{25}} - \frac{1}{T} \right) \right]}$$

T: Thermistor temperature
R_T: Thermistor value at T

Package outline

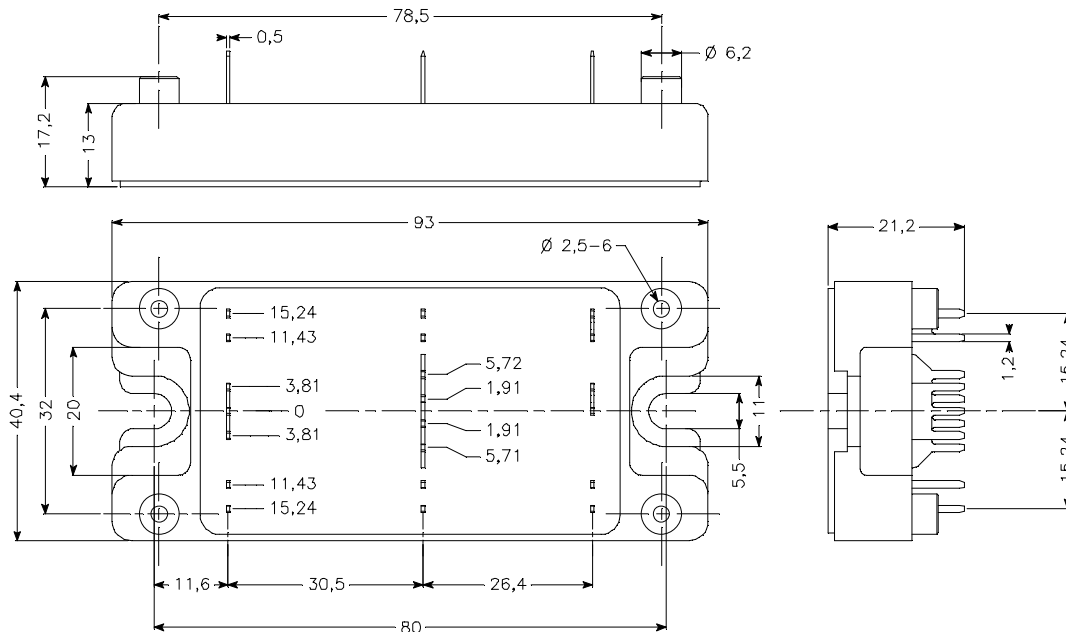

Typical CoolMOS Performance Curve

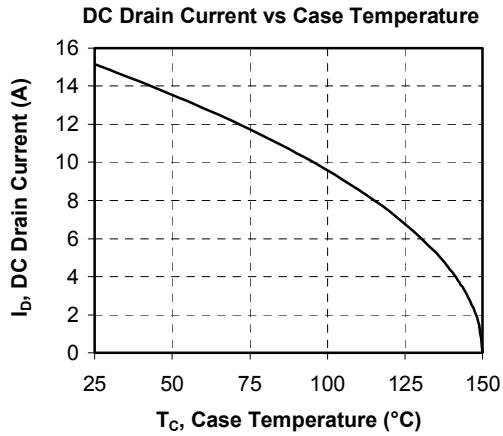
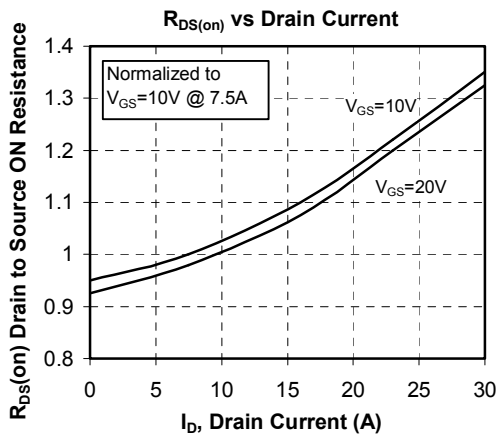
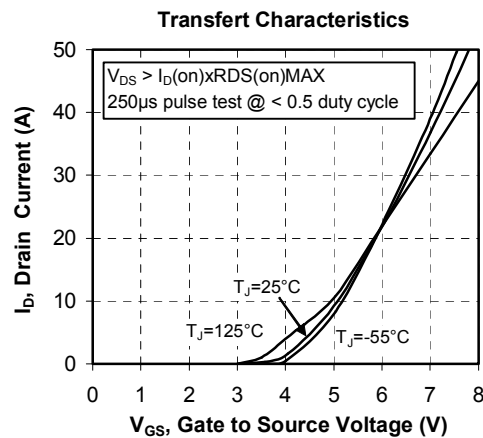
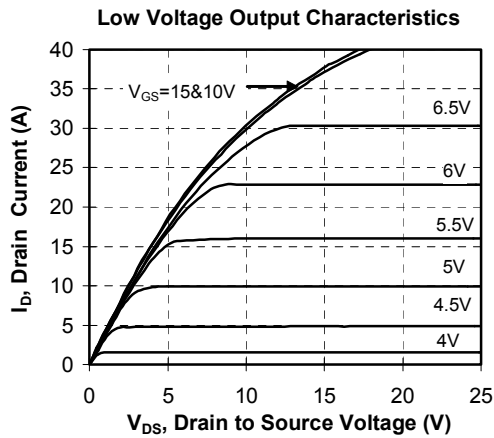
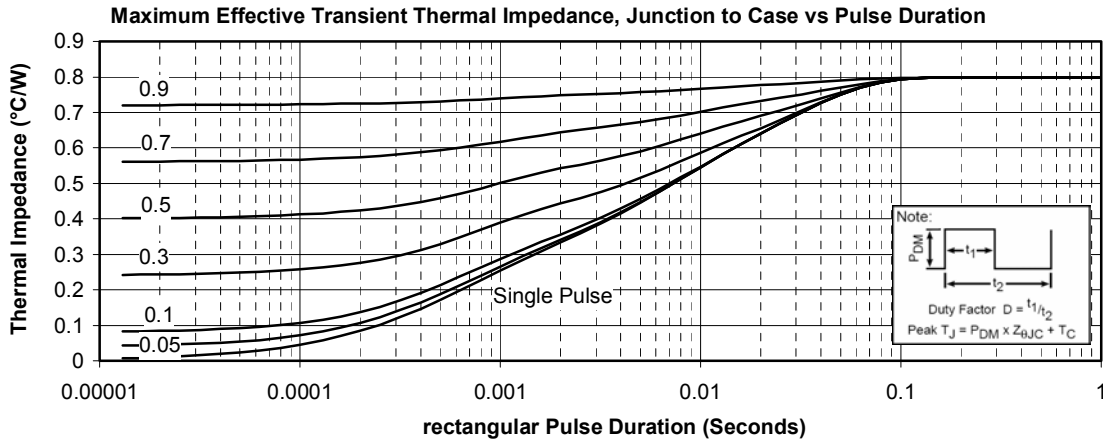

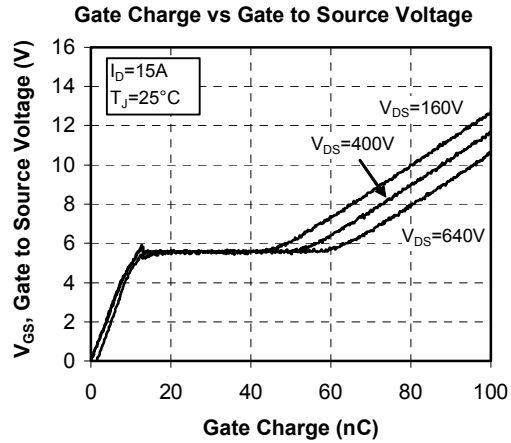
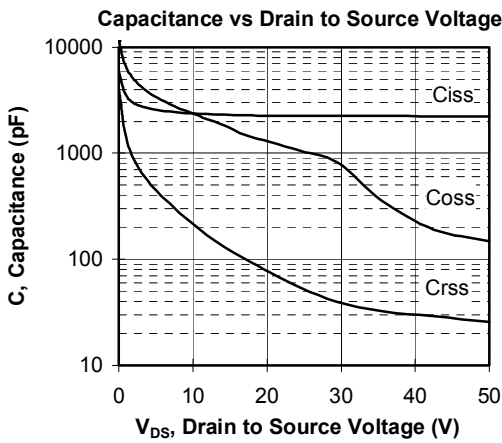
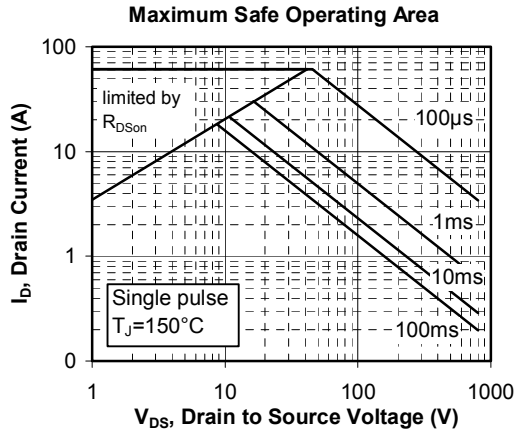
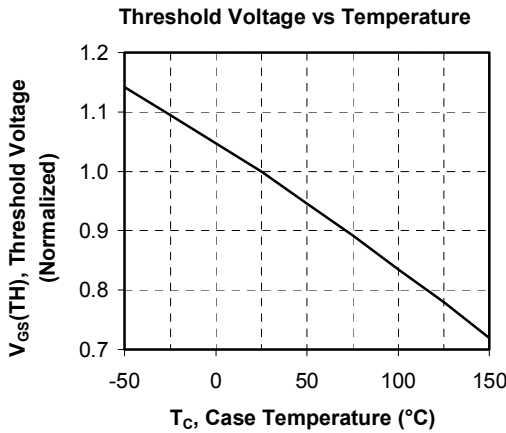
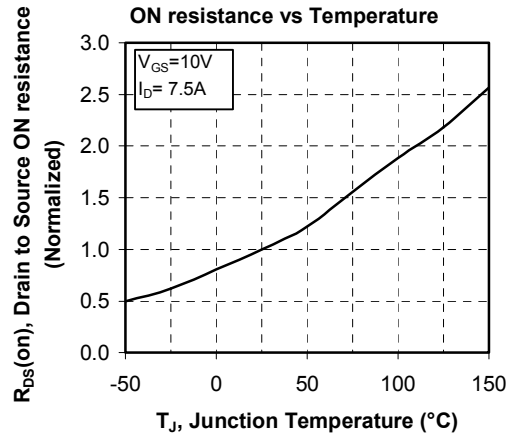
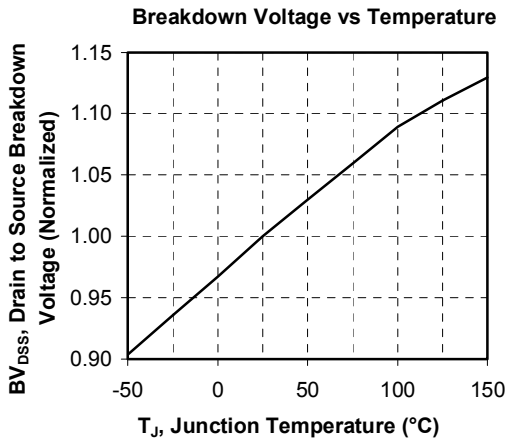

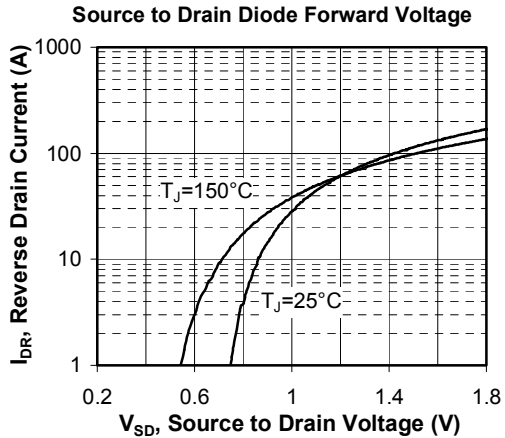
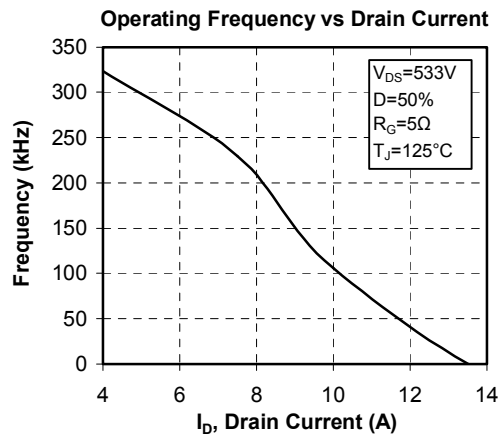
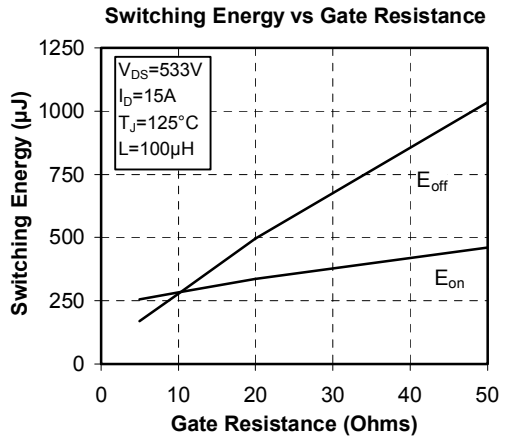
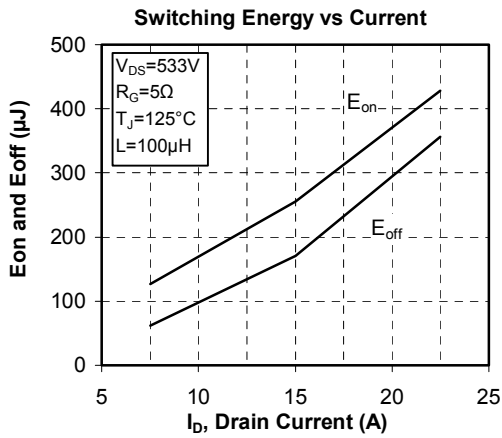
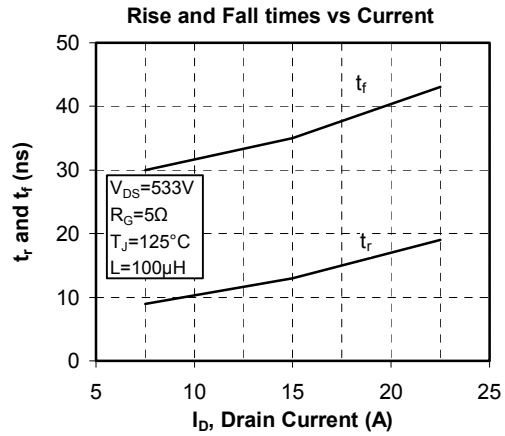
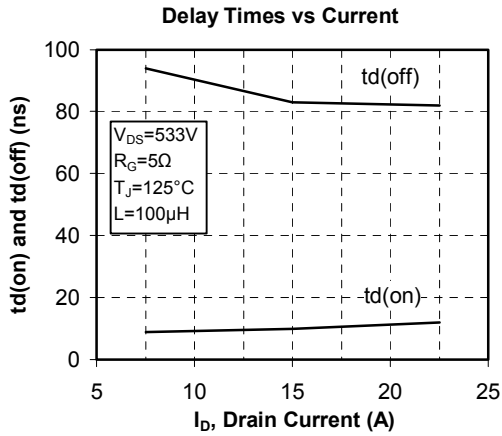

Typical SiC Diode Performance Curve

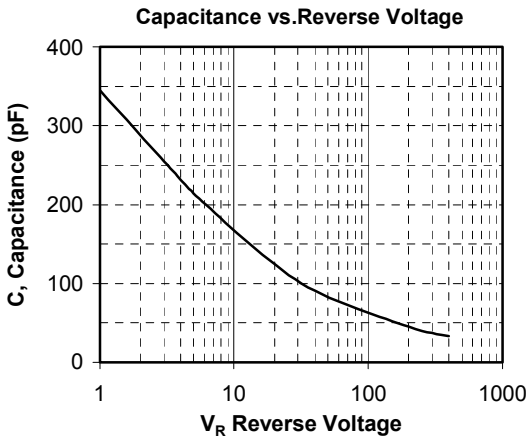
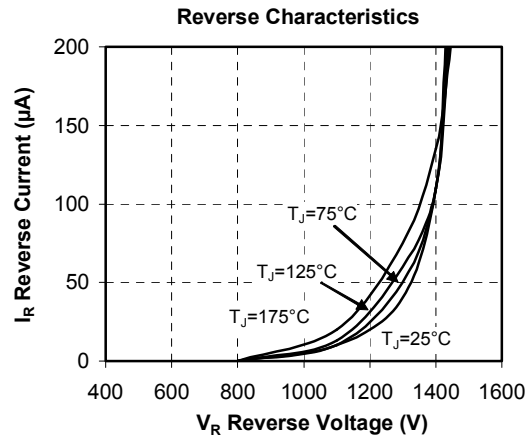
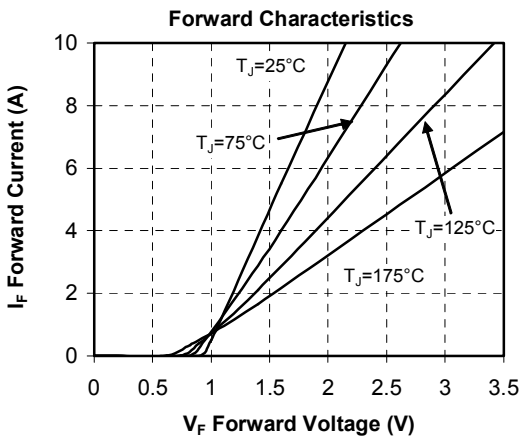
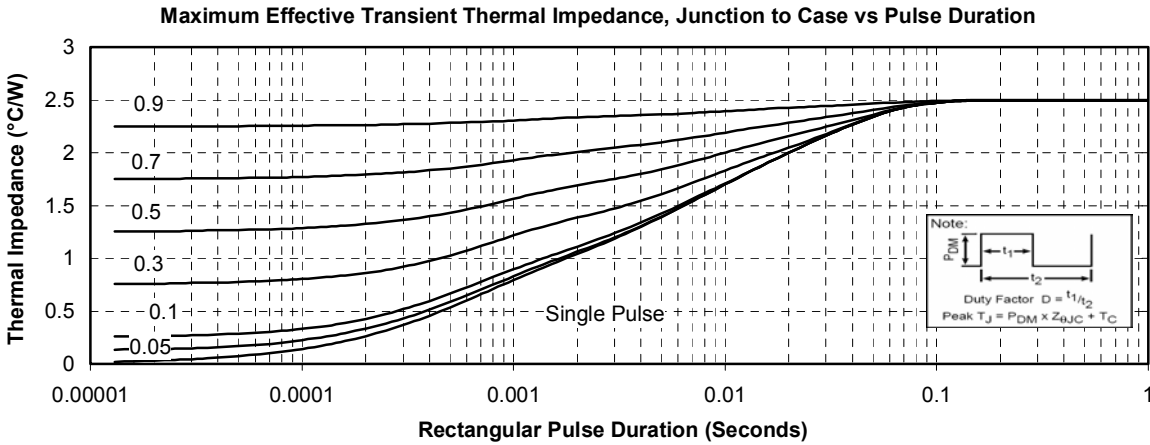

“COOLMOS™” comprise a new family of transistors developed by Infineon Technologies AG. “COOLMOS” is a trademark of Infineon Technologies AG”.

APT reserves the right to change, without notice, the specifications and information contained herein

APT's products are covered by one or more of U.S patents 4,895,810 5,045,903 5,089,434 5,182,234 5,019,522 5,262,336 6,503,786 5,256,583 4,748,103 5,283,202 5,231,474 5,434,095 5,528,058 and foreign patents. U.S and Foreign patents pending. All Rights Reserved.