

POWER MOS V®

Power MOS V® is a new generation of high voltage N-Channel enhancement mode power MOSFETs. This new technology minimizes the JFET effect, increases packing density and reduces the on-resistance. Power MOS V® also achieves faster switching speeds through optimized gate layout.

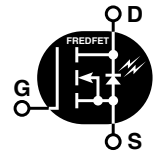
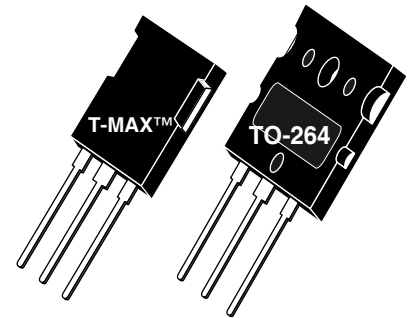

- **Faster Switching**
- **Lower Leakage**
- **Avalanche Energy Rated**
- **Popular T-MAX™ or TO-264 Package**

MAXIMUM RATINGS

 All Ratings: $T_C = 25^\circ\text{C}$ unless otherwise specified.

Symbol	Parameter	APT12080B2VFR_LVFR	UNIT
V_{DSS}	Drain-Source Voltage	1200	Volts
I_D	Continuous Drain Current @ $T_C = 25^\circ\text{C}$	16	Amps
I_{DM}	Pulsed Drain Current ^①	64	
V_{GS}	Gate-Source Voltage Continuous	± 30	Volts
V_{GSM}	Gate-Source Voltage Transient	± 40	
P_D	Total Power Dissipation @ $T_C = 25^\circ\text{C}$	520	Watts
	Linear Derating Factor	4.16	W/ $^\circ\text{C}$
T_J, T_{STG}	Operating and Storage Junction Temperature Range	-55 to 150	$^\circ\text{C}$
T_L	Lead Temperature: 0.063" from Case for 10 Sec.	300	
I_{AR}	Avalanche Current ^① (Repetitive and Non-Repetitive)	16	Amps
E_{AR}	Repetitive Avalanche Energy ^①	50	mJ
E_{AS}	Single Pulse Avalanche Energy ^④	2500	

STATIC ELECTRICAL CHARACTERISTICS

Symbol	Characteristic / Test Conditions	MIN	TYP	MAX	UNIT
BV_{DSS}	Drain-Source Breakdown Voltage ($V_{GS} = 0V, I_D = 250\mu\text{A}$)	1200			Volts
$R_{DS(on)}$	Drain-Source On-State Resistance ^② ($V_{GS} = 10V, I_D = 8A$)			0.800	Ohms
I_{DSS}	Zero Gate Voltage Drain Current ($V_{DS} = 1200, V_{GS} = 0V$)			250	μA
	Zero Gate Voltage Drain Current ($V_{DS} = 960V, V_{GS} = 0V, T_C = 125^\circ\text{C}$)			1000	
I_{GSS}	Gate-Source Leakage Current ($V_{GS} = \pm 30V, V_{DS} = 0V$)			± 100	nA
$V_{GS(th)}$	Gate Threshold Voltage ($V_{DS} = V_{GS}, I_D = 2.5mA$)	2		4	Volts

 **CAUTION:** These Devices are Sensitive to Electrostatic Discharge. Proper Handling Procedures Should Be Followed.

DYNAMIC CHARACTERISTICS

APT12080B2VFR_LVFR

Symbol	Characteristic	Test Conditions	MIN	TYP	MAX	UNIT
C_{iss}	Input Capacitance	$V_{GS} = 0V$ $V_{DS} = 25V$ $f = 1\text{ MHz}$		6500	7800	pF
C_{oss}	Output Capacitance			530	740	
C_{rss}	Reverse Transfer Capacitance			250	375	
Q_g	Total Gate Charge ^③	$V_{GS} = 10V$ $V_{DD} = 0.5 V_{DSS}$ $I_D = I_D [\text{Cont.}] @ 25^\circ\text{C}$		325	485	nC
Q_{gs}	Gate-Source Charge			29	45	
Q_{gd}	Gate-Drain ("Miller") Charge			145	215	
$t_{d(on)}$	Turn-on Delay Time	$V_{GS} = 15V$ $V_{DD} = 0.5 V_{DSS}$ $I_D = I_D [\text{Cont.}] @ 25^\circ\text{C}$ $R_G = 0.6\Omega$		16	32	ns
t_r	Rise Time			12	24	
$t_{d(off)}$	Turn-off Delay Time			59	90	
t_f	Fall Time			12	24	

SOURCE-DRAIN DIODE RATINGS AND CHARACTERISTICS

Symbol	Characteristic / Test Conditions	MIN	TYP	MAX	UNIT
I_S	Continuous Source Current (Body Diode)			16	Amps
I_{SM}	Pulsed Source Current ^① (Body Diode)			64	
V_{SD}	Diode Forward Voltage ^② ($V_{GS} = 0V, I_S = -I_D [\text{Cont.}]$)			1.3	Volts
dv/dt	Peak Diode Recovery dv/dt ^⑤			18	V/ns
t_{rr}	Reverse Recovery Time ($I_S = -I_D [\text{Cont.}], di/dt = 100A/\mu s$)	$T_j = 25^\circ\text{C}$		350	ns
		$T_j = 125^\circ\text{C}$		700	
Q_{rr}	Reverse Recovery Charge ($I_S = -I_D [\text{Cont.}], di/dt = 100A/\mu s$)	$T_j = 25^\circ\text{C}$		2	μC
		$T_j = 125^\circ\text{C}$		6	
I_{RRM}	Peak Recovery Current ($I_S = -I_D [\text{Cont.}], di/dt = 100A/\mu s$)	$T_j = 25^\circ\text{C}$		12	Amps
		$T_j = 125^\circ\text{C}$		22	

THERMAL CHARACTERISTICS

Symbol	Characteristic	MIN	TYP	MAX	UNIT
$R_{\theta JC}$	Junction to Case			0.24	$^\circ\text{C/W}$
$R_{\theta JA}$	Junction to Ambient			40	

- ① Repetitive Rating: Pulse width limited by maximum junction temperature.
- ② Pulse Test: Pulse width < 380 μs , Duty Cycle < 2%
- ③ See MIL-STD-750 Method 3471
- ④ Starting $T_j = +25^\circ\text{C}$, $L = 19.53\text{mH}$, $R_G = 25\Omega$, Peak $I_L = 16\text{A}$
- ⑤ $I_S \leq I_D [\text{Cont.}]$, $di/dt = 100\text{A}/\mu\text{s}$, $T_j \leq 150^\circ\text{C}$, $R_G = 2.0\Omega$, $V_R = 200\text{V}$.

APT Reserves the right to change, without notice, the specifications and information contained herein.

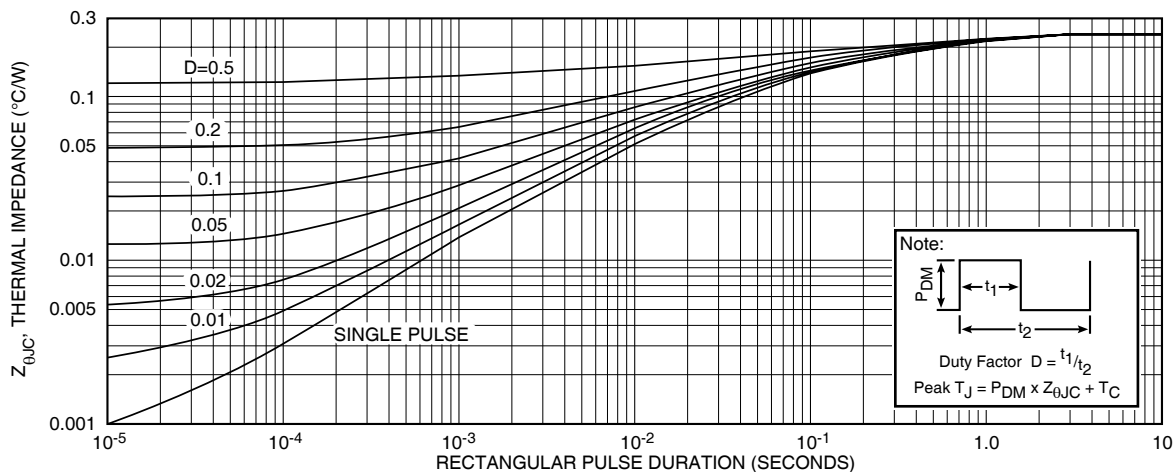

FIGURE 1, MAXIMUM EFFECTIVE TRANSIENT THERMAL IMPEDANCE, JUNCTION-TO-CASE vs PULSE DURATION

Typical Performance Curves

APT12080B2VFR_LVFR

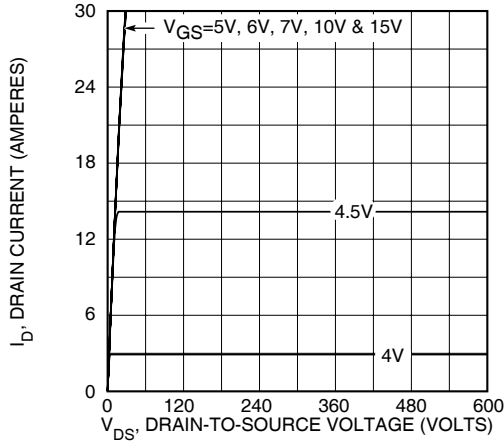

FIGURE 2, TYPICAL OUTPUT CHARACTERISTICS

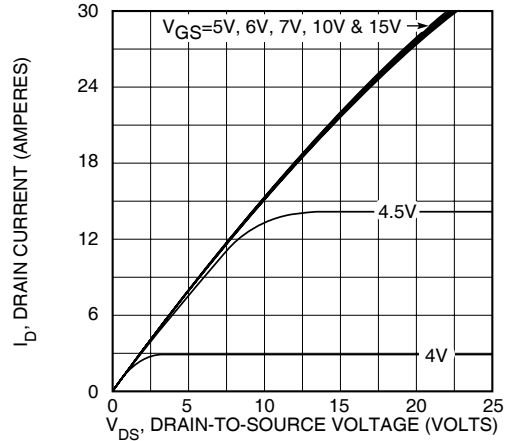

FIGURE 3, TYPICAL OUTPUT CHARACTERISTICS

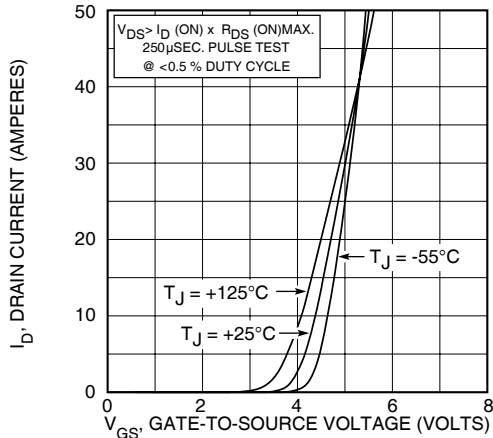

FIGURE 4, TYPICAL TRANSFER CHARACTERISTICS

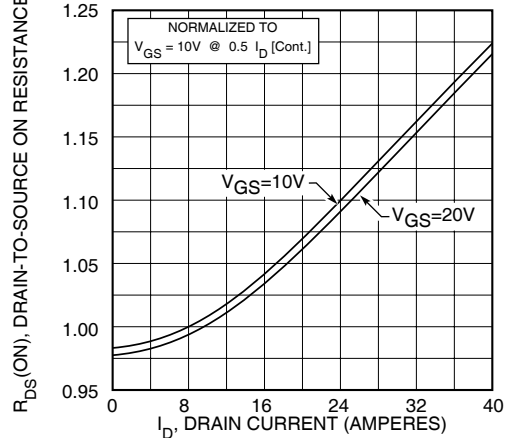

FIGURE 5, $R_{DS(ON)}$ vs DRAIN CURRENT

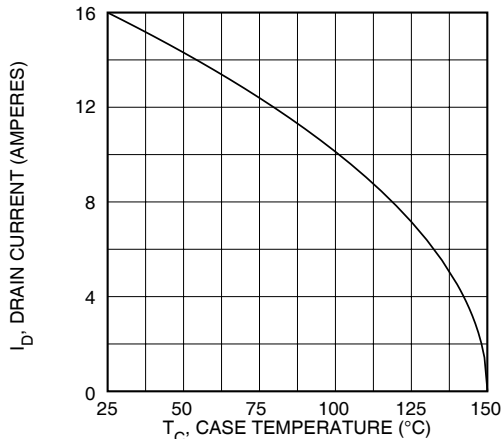

FIGURE 6, MAXIMUM DRAIN CURRENT vs CASE TEMPERATURE

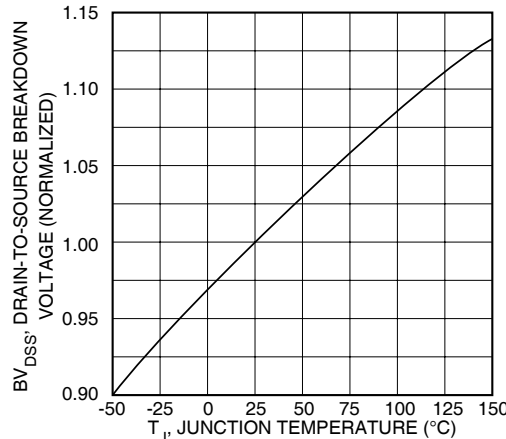

FIGURE 7, BREAKDOWN VOLTAGE vs TEMPERATURE

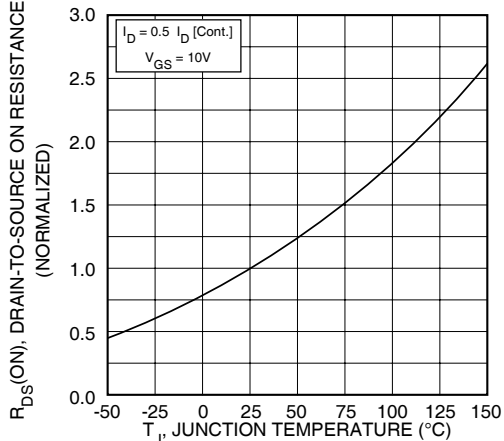

FIGURE 8, ON-RESISTANCE vs. TEMPERATURE

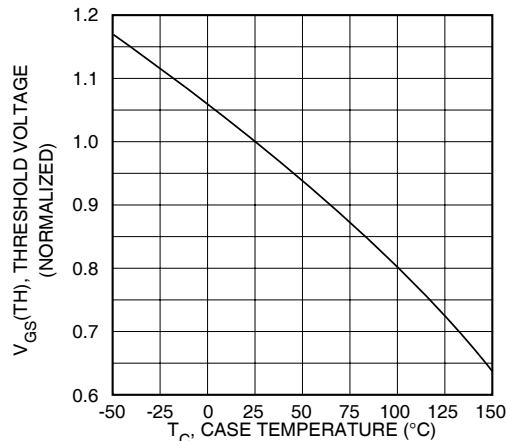

FIGURE 9, THRESHOLD VOLTAGE vs TEMPERATURE

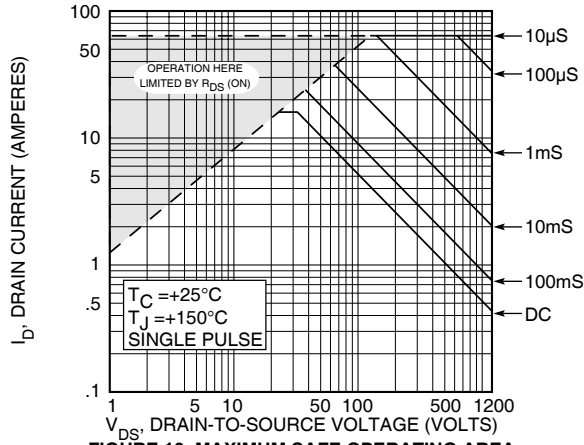

FIGURE 10, MAXIMUM SAFE OPERATING AREA

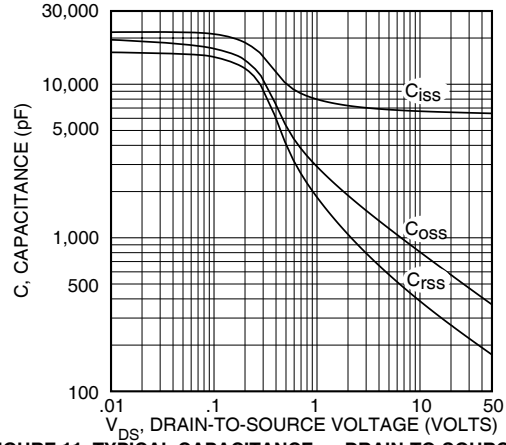

FIGURE 11, TYPICAL CAPACITANCE vs DRAIN-TO-SOURCE VOLTAGE

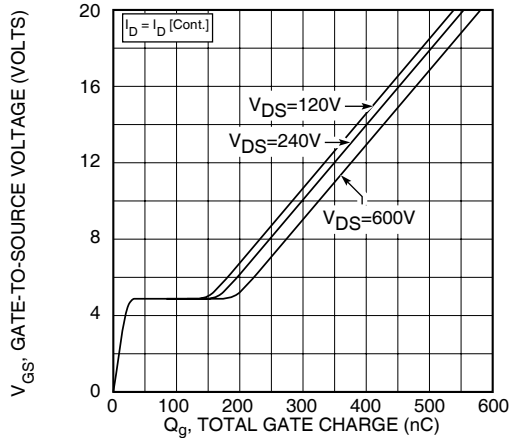

FIGURE 12, GATE CHARGES vs GATE-TO-SOURCE VOLTAGE

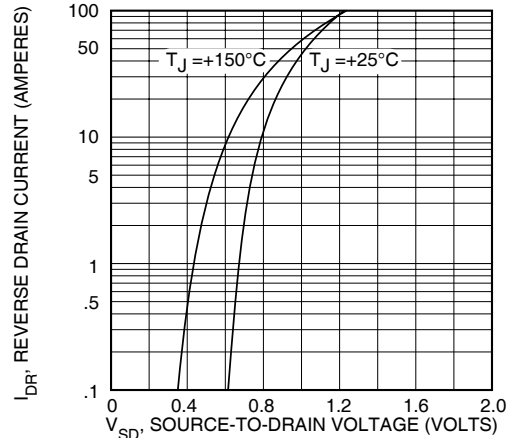
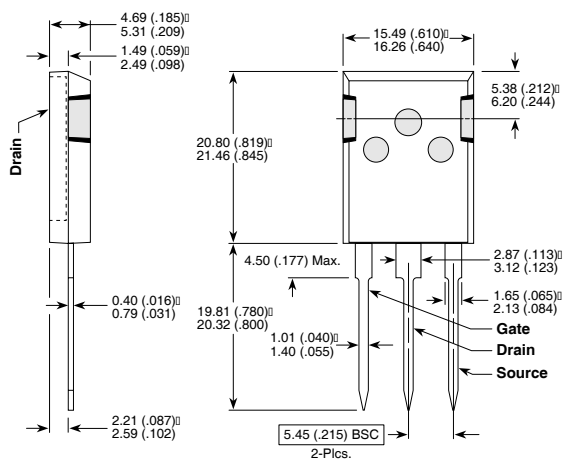

FIGURE 13, TYPICAL SOURCE-DRAIN DIODE FORWARD VOLTAGE

T-MAX™ (B2) Package Outline



These dimensions are equal to the TO-247 without the mounting hole.
Dimensions in Millimeters and (Inches)

TO-264 (L) Package Outline

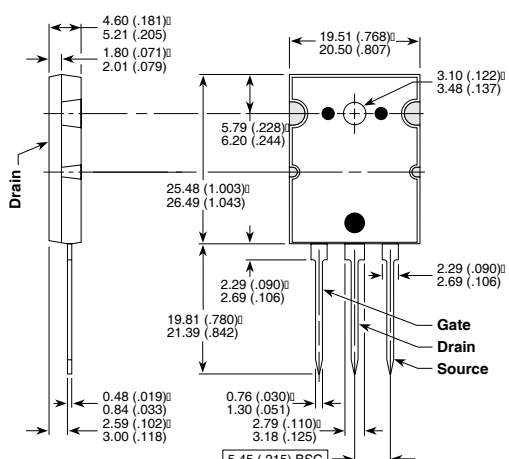

Dimensions in Millimeters and (Inches)