



AKD5353

Evaluation board Rev.B for AK5353

GENERAL DESCRIPTION

AKD5353 is an evaluation board for 96kHz 24bit A/D converter AK5353. AKD5353 includes the input buffer circuit and also has a digital interface transmitter. Further, the AKD5353 can evaluate direct interface with AKM's D/A converter evaluation boards.

■ **Ordering guide**

AKD5353 --- Evaluation board for AK5353

FUNCTION

- On-board single-ended input buffer circuit
- On-board clock generator
- Compatible with 2 types of interface
 - Direct interface with AKM's D/A converter evaluation boards
 - On-board CS8402 as DIT which transmits optical output
- BNC connector for an external clock input

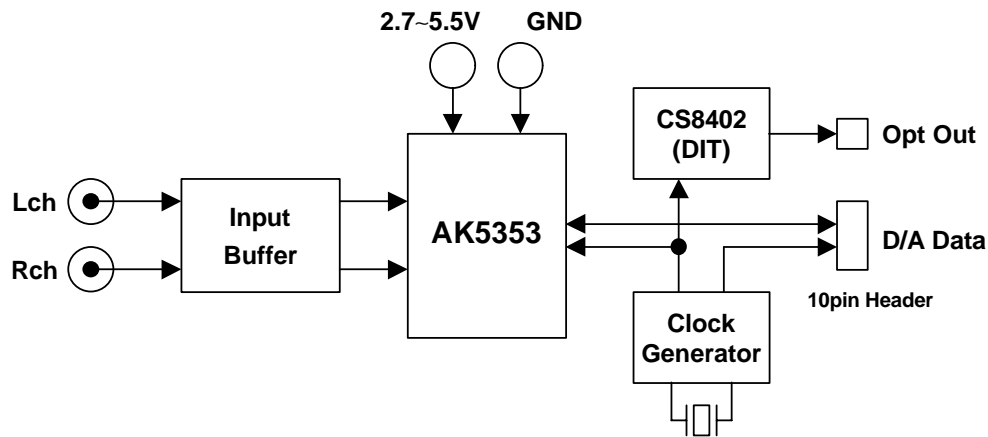

Figure 1. AKD5353 Block Diagram

* Circuit diagram and PCB layout are attached at the end of this manual.

■ Analog Inputs

J1(AINL) and J2(AINR) are used.

The analog inputs are single-ended and each signal range is nominally 3.0V_{pp}@5V.

It is proportional to VA ($V_{in}=0.6 \times VA$).

■ Operation sequence

1) Set up the power supply lines.

[VA] (red) = 2.7~5.5V : for VA of AK5353

[3V] (orange) = 2.7~5.5V : for VD of AK5353

[5V] (red) = 3.4~5.5V : for logic

[AGND] (black)= 0V : for analog ground (including AGND and DGND of AK5353)

[DGND] (black)= 0V : for logic ground

Each supply line should be distributed from the power supply unit.

2) Set up the evaluation mode, jumper pins and DIP switches. (See the followings.)

3) Power on.

The AK5353 should be reset once bringing SW4 (5353_PD) "L" upon power-up.

■ Evaluation mode

1) DIT (Optical Link) <default>

PORT1 (TOTX174) is used. DIT generates audio bi-phase signal from received data and which is output through optical connector (TOTX174). It is possible to connect AKM's D/A converter evaluation boards on the digital-amplifier which equips DIR input. JP6 and JP7 should be selected same mode as AK5353. In case of using external clock through a BNC connector (J3), select BNC on JP5(CLK) and short JP4(XTE).

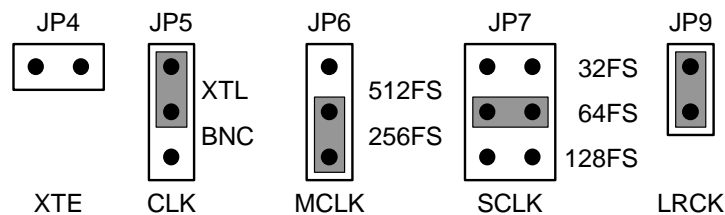

2) Using D/A converter board

The AK5353 can be evaluated by distortion analyzer using various AKM's D/A converter evaluation boards. They can be connected by 10pin flat cable via PORT2(DAC/ROM). If the AKD5353 feeds all interface signals (MCLK,BICK,LRCK) to D/A converter board, jumper set up is same as 1) (See above). If all interface signals are fed from D/A converter board, jumper set up is same as 3) (See below).

3) All interface signals (MCLK,SCLK,LRCK) are fed from the external circuit through PORT2
 PORT2 (DAC/ROM) is used. JP5,7 and 9 should be open. Selection of JP6 is no care but should not be open.

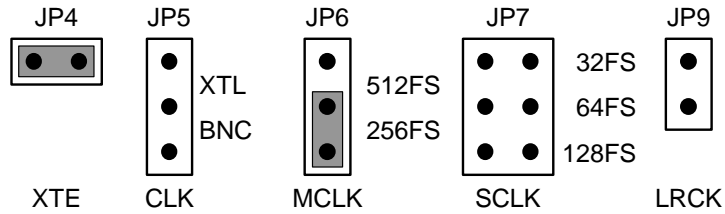

■ Other jumper pins set up

[JP1](VD): VD of AK5353
 3V: independent of VA <default>
 VA: same as VA (The connector “3V” should be open.)

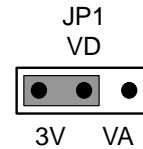

[JP2](DGND-AGND): Analog ground and digital ground
 open: separated <default>
 short: common (The connector “DGND” can be open.)

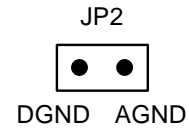

[JP3](5V-3V): VD of AK5353 and power supply to logic
 open: independent <default>
 short: same (The connector “3V” should be open.)

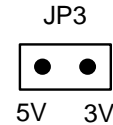

[JP8](8402_DIF): Always “MSB”

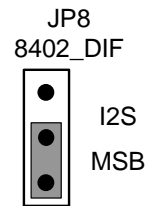

■ The function of the toggle SW.

Upper-side is “H” and lower-side is “L”.

[SW2]: Resets the CS8402. Keep “H” during normal operation.
 [SW4]: Resets the AK5353. Keep “H” during normal operation.

■ DIP switch set up.

[SW3]: Sets the mode of AK5353.

No.	Pin	ON	OFF (default)
1	DIF	I2S	MSB justified
2	TTL	TTL interface	CMOS interface

Table 1. DIP switch set-up of AK5353

[SW1]: Sets the C-bit of CS8402. (Default is the consumer mode.)

This set up does not affect the evaluation of the AK5353. In case of using DIT, need to set it up correctly.
For more detailed configurations, please refer to the CS8402 data sheet.

Switch	OFF=0, ON=1	Contents
8	<u>PRO</u> =0	Professional mode, C0=1
7,6	<u>C6</u> , <u>C7</u>	C6,C7 – Sampling frequency
	11	00 – Not indicated. Receiver default to 48kHz.
	10	01 – 48kHz
	01	10 – 44.1kHz
	00	11 – 32kHz
5	<u>C9</u>	C8,C9,C10,C11 – 1bit of channel mode
	1	0000 – Mode not indicated. Receiver default to 2-channel mode.
	0	0100 – Stereophonic.
4	<u>C1</u>	C1 – Audio mode
	1	0 – Normal audio
	0	1 – Non-audio
3	<u>TRNPT</u>	Transparent mode *CS8402 is CRE
	0	Normal mode
	1	Transparent mode
1,2	<u>EM1</u> , <u>EM0</u>	C2,C3,C4 – Encoded audio signal emphasis
	11	000 – Emphasis not indicated. Receiver defaults to no emphasis with manual override enabled.
	10	100 – None
	01	110 – 50/15usec
	00	111 – CCITT J.17

Table 2. DIP switch set-up of CS8402 (Professional mode)

Switch	OFF=0, ON=1	Contents
8	<u>PRO</u> =1	Consumer mode, C0=0
7	<u>C2</u>	C2 – Copy
	1	0 – Copy inhibited
Default	0	1 – Copy permitted
6	<u>C3</u>	C3,C4,C5 – Pre-emphasis
Default	1	000 – None
	0	100 – 50/15usec
5	<u>C15</u>	C15 – General Status
	1	0 – See the standard
Default	0	1 – See the standard
3,4	<u>FC1</u> , <u>FC0</u>	C24,C25,C26,C27 – Sampling frequency
	00	0000 – 44.1kHz
Default	01	0100 – 48kHz
	10	1100 – 32kHz
	11	0000 – 44.1kHz, CD mode
1,2	<u>C8</u> , <u>C9</u>	C8-C14 – Category code
Default	11	0000000 – General
	10	0100000 – PCM encoder/decoder
	01	1000000 – CD
	00	1100000 – DAT

Table 3. DIP switch set-up of CS8402 (Consumer mode; default)

MEASUREMENT RESULTS

[Measurement condition]

- Measurement unit : ROHDE & SCHWARZ, UPD04
- MCLK : 256fs
- BICK : 64fs
- fs : 48kHz
- BW : 20Hz~20kHz (fs=48kHz), 40Hz~40kHz (fs=96kHz)
- Bit : 24bit
- Power Supply : VA=VD=5V or 3V
- Interface : DIT (fs=48kHz), Serial Multiplex (fs=96kHz)
- Temperature : Room

Parameter	Input signal	Measurement filter	5V, 48kHz	3V, 48kHz
S/(N+D)	1kHz, -1dB	20kLPF	83.3dB	90.4dB
DR	1kHz, -60dB	20kLPF, A-weighted	98.4dB	95.3dB
S/N	no signal	20kLPF, A-weighted	98.6dB	95.3dB

Parameter	Input signal	Measurement filter	5V, 96kHz
S/(N+D)	1kHz, -1dB	40kLPF	84.7dB
DR	1kHz, -60dB	40kLPF	95.3dB
S/N	no signal	40kLPF	95.3dB

[Measurement condition]

- Measurement unit : Audio Precision, System two
- MCLK : 256fs
- BICK : 64fs
- fs : 48kHz
- BW : 20Hz~20kHz
- Bit : 24bit
- Power Supply : VA=VD=5V or 3V
- Interface : DIT
- Temperature : Room

Parameter	Input signal	Measurement filter	5V, 48kHz	3V, 48kHz
S/(N+D)	1kHz, -1dB	20kLPF	83.3dB	88.8dB
DR	1kHz, -60dB	20kLPF, A-weighted	97.5dB	94.6dB
S/N	no signal	20kLPF, A-weighted	97.8dB	94.6dB

■ Plots

[Measurement condition]

- Measurement unit : Audio Precision, System two, Cascade (fs=48kHz),
ROHDE & SCHWARZ, UPD04 (fs=96kHz)
- MCLK : 256fs
- BICK : 64fs
- fs : 48kHz or 96kHz
- BW : 20Hz~20kHz (fs=48kHz), 40Hz~40kHz (fs=96kHz)
- Bit : 24bit
- Power Supply : VA=VD=5V
- Interface : DIT (fs=48kHz), Serial Multiplex (fs=96kHz)
- Temperature : Room

fs=48kHz

- Figure 2. THD+N vs Input Level (fin=1kHz)
- Figure 3. THD+N vs fin (-1dBFS input)
- Figure 4. Linearity (fin=1kHz)
- Figure 5. Frequency Response (-1dBFS input)
- Figure 6. Cross-talk (-1dBFS input)
- Figure 7. FFT (1kHz, -1dBFS input)
- Figure 8. FFT (1kHz, -60dBFS input)
- Figure 9. FFT (noise floor)

fs=96kHz

- Figure 10. THD+N vs Input Level (fin=1kHz)
- Figure 11. THD+N vs fin (-1dBFS input)
- Figure 12. Linearity (fin=1kHz)
- Figure 13. Frequency Response (-1dBFS input)

AKM

AK5353 THD+N vs Input Level (fs=48kHz, fin=1kHz)

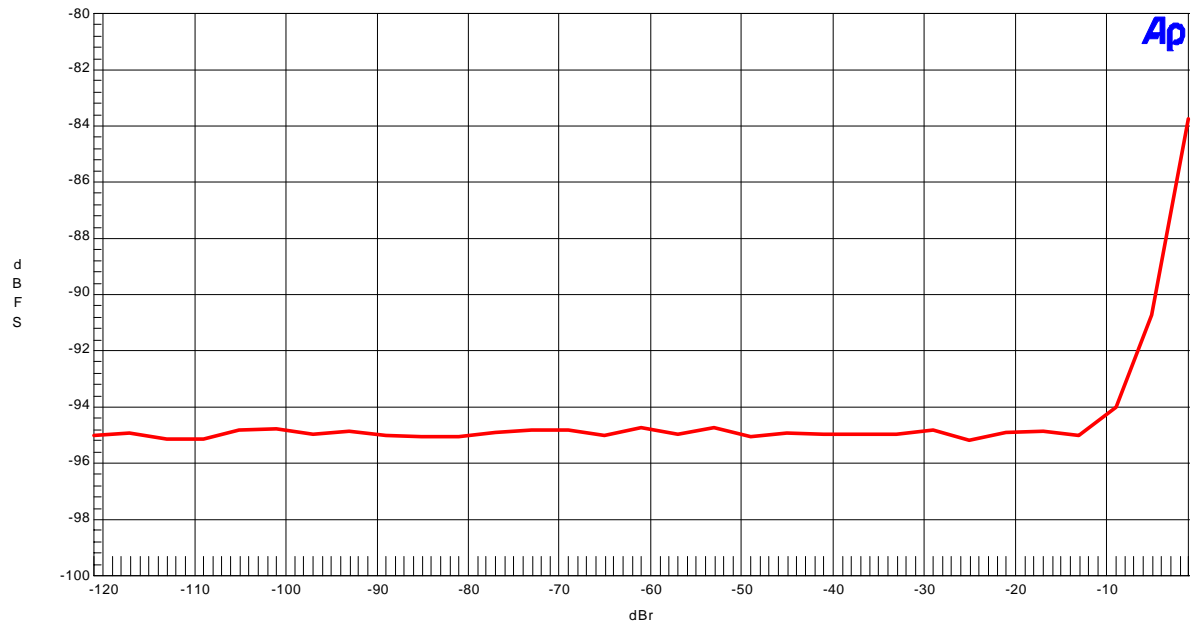

Figure 2. THD+N vs Input Level (fs=48kHz; fin=1kHz)

AKM

AK5353 THD+N vs fin (fs=48kHz, -1dBFS input)

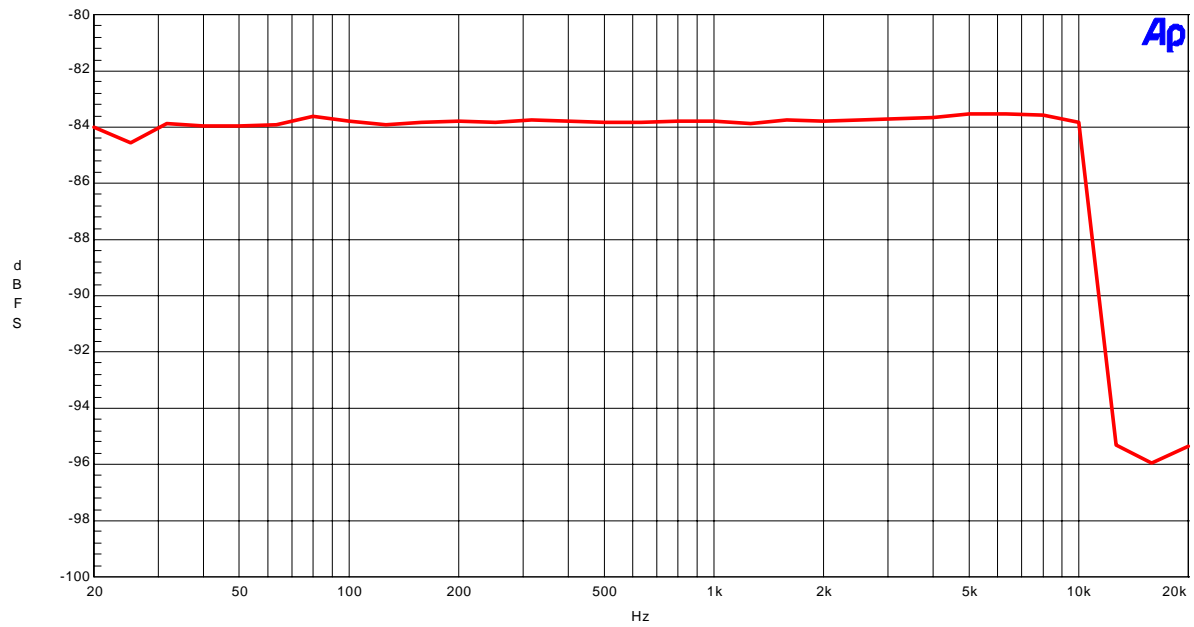

Figure 3. THD+N vs fin (fs=48kHz; -1dBFS input)

AKM

AK5353 Linearity (fs=48kHz, fin=1kHz)

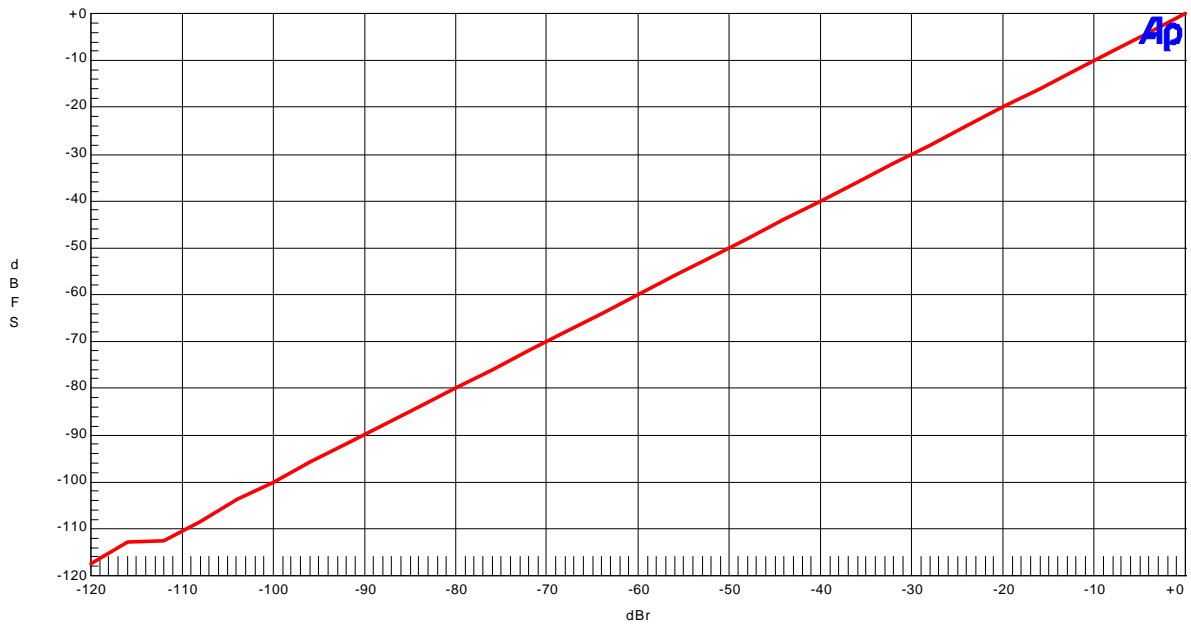

Figure 4. Linearity (fs=48kHz; fin=1kHz)

AKM

AK5353 Frequency Response (fs=48kHz, -1dBFS input)

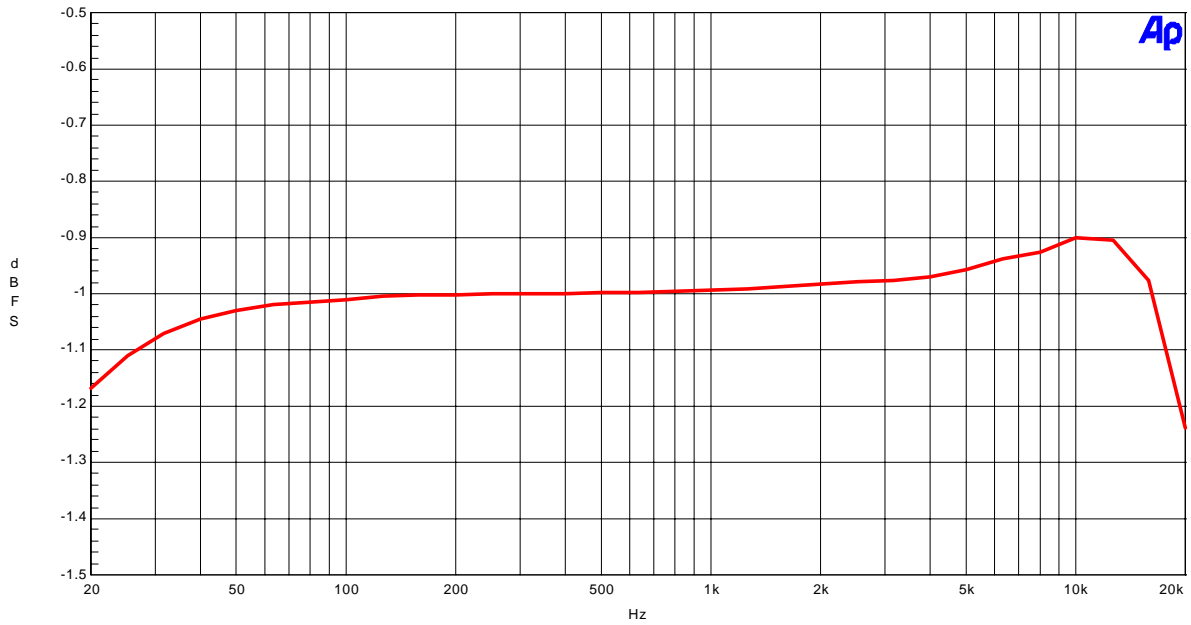

Figure 5. Frequency Response (fs=48kHz; -1dBFS input)

AKM

AK5353 Cross-talk (fs=48kHz, -1dBFS input)

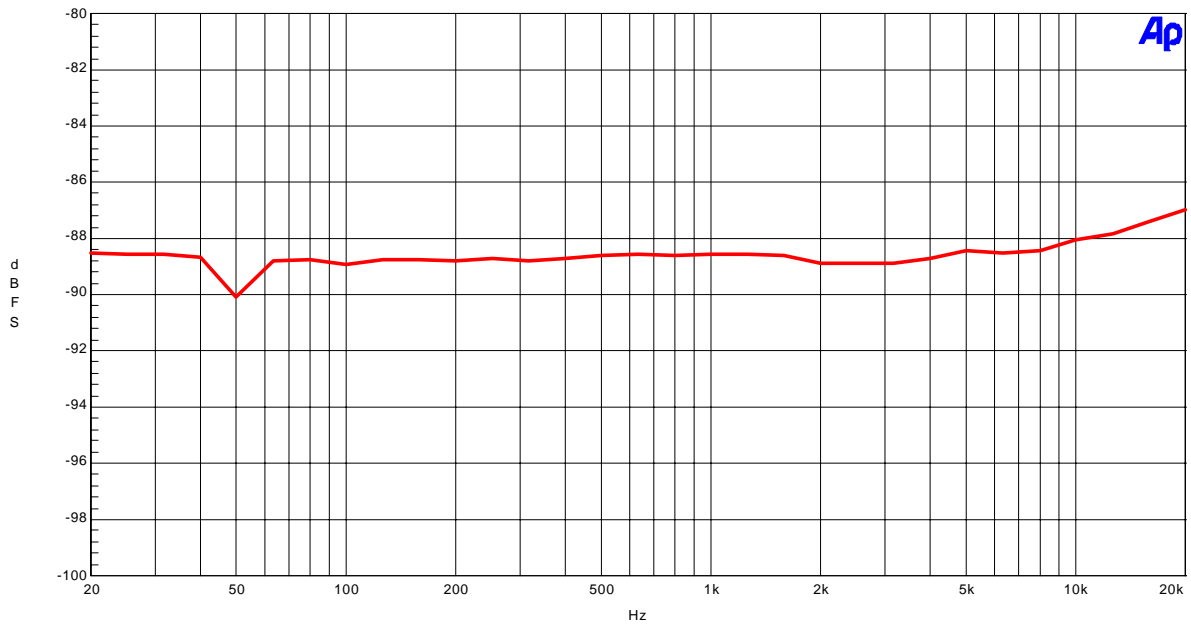

Figure 6. Cross-talk (fs=48kHz; -1dBFS input)

AKM

AK5353 FFT (fs=48kHz, 1kHz, -1dBFS input)
FFT point=16384, Avg=8

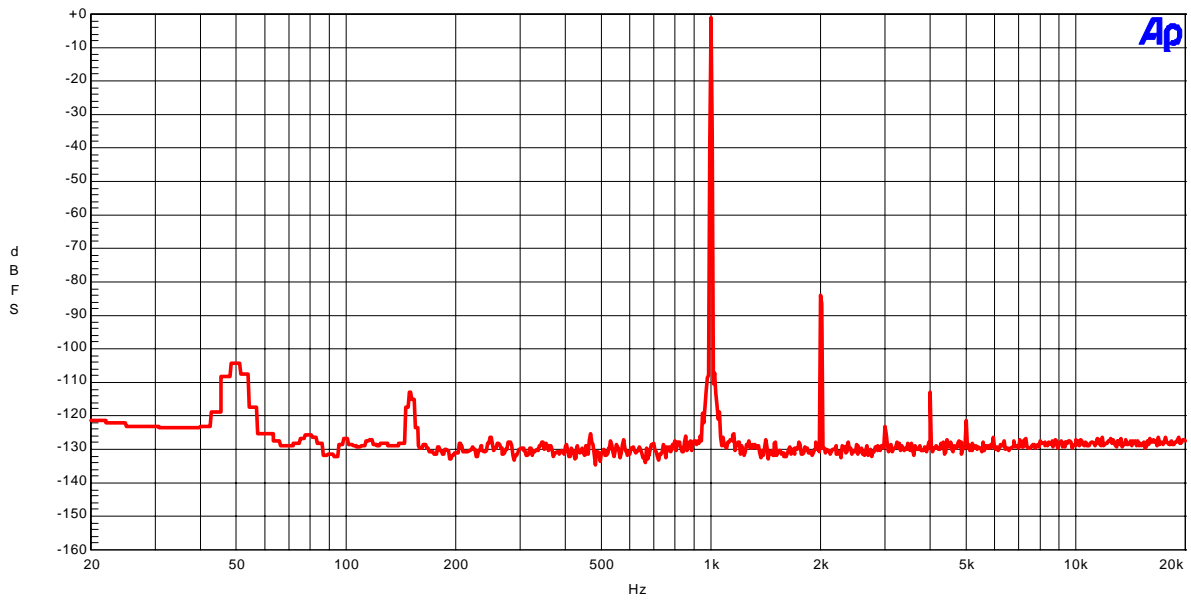

Figure 7. FFT (fs=48kHz; 1kHz, -1dBFS input)
FFT point=16384, Avg=8

AKM

AK5353 FFT (fs=48kHz, 1kHz, -60dBFS input)
FFT point=16384, Avg=8

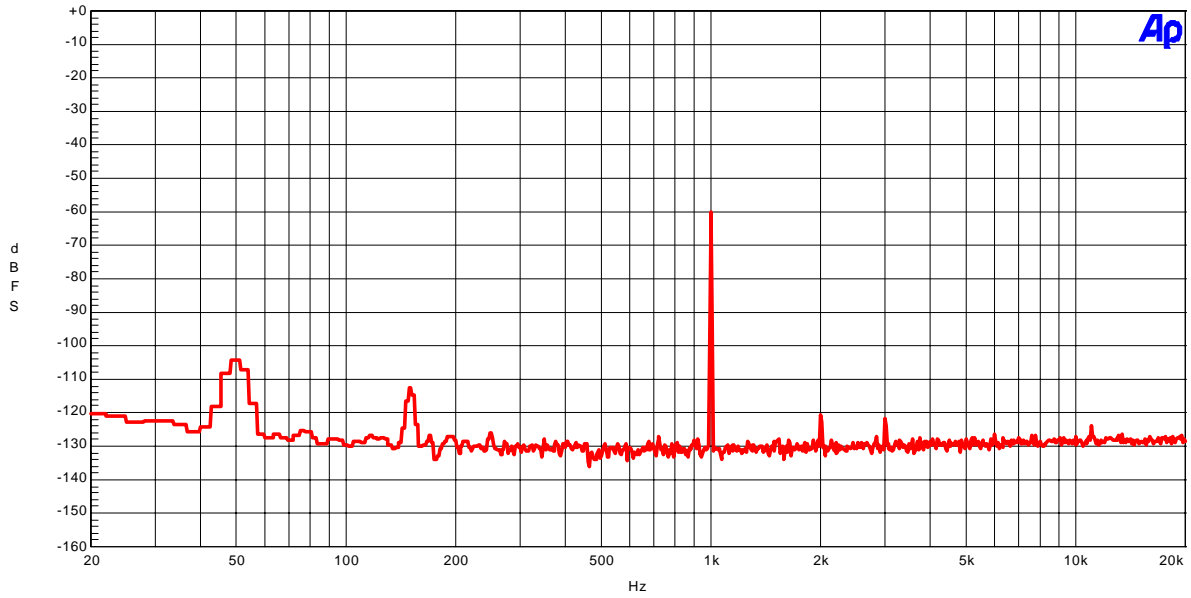

Figure 8. FFT (fs=48kHz; 1kHz, -60dBFS input)
FFT point=16384, Avg=8

AKM

AK5353 FFT (noise floor; fs=48kHz, no signal input)
FFT point=16384, Avg=8

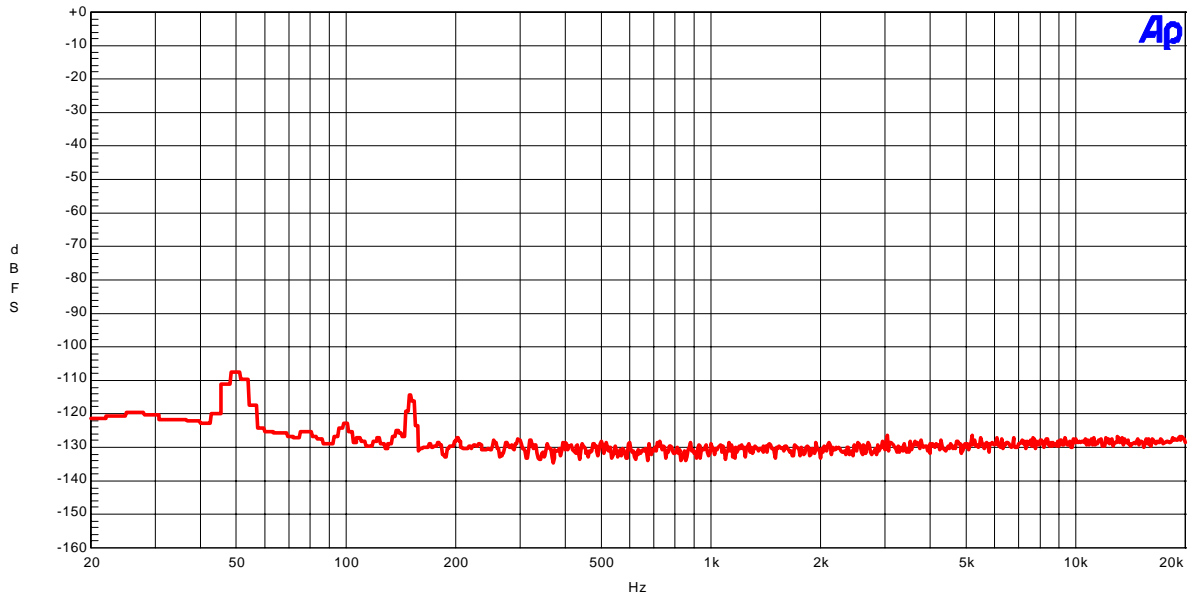

Figure 9. FFT (noise floor; fs=48kHz, no signal input)
FFT point=16384, Avg=8

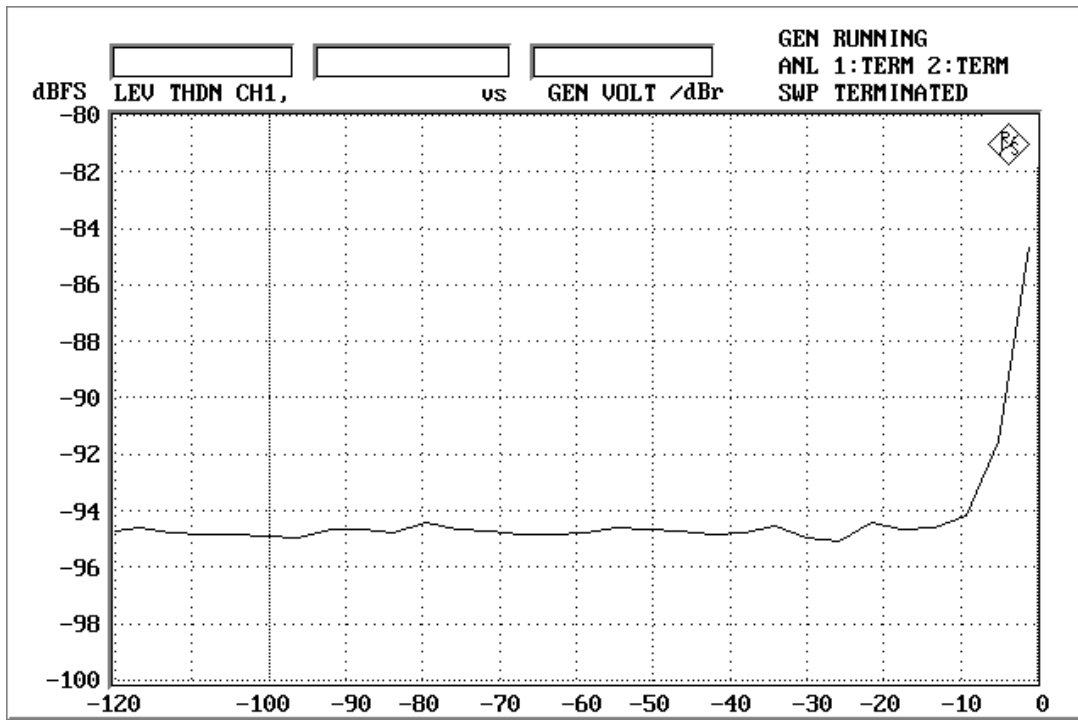

Figure 10. THD+N vs Input Level (fs=96kHz; fin=1kHz)

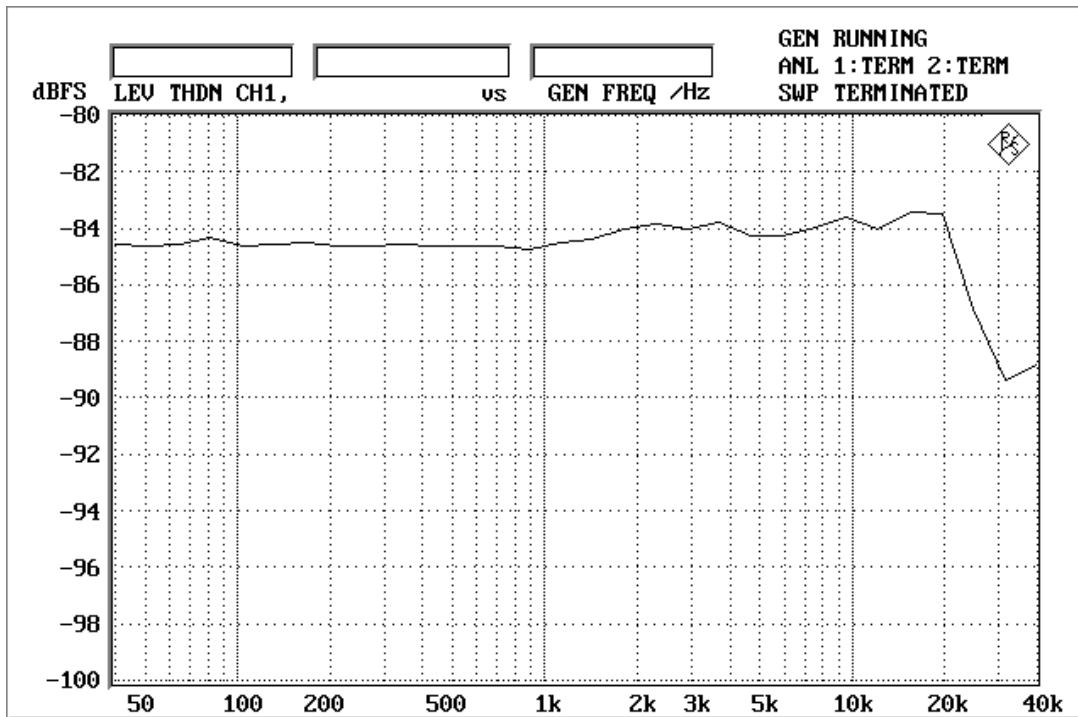

Figure 11. THD+N vs fin (fs=96kHz; Input Level=-1dBFS)

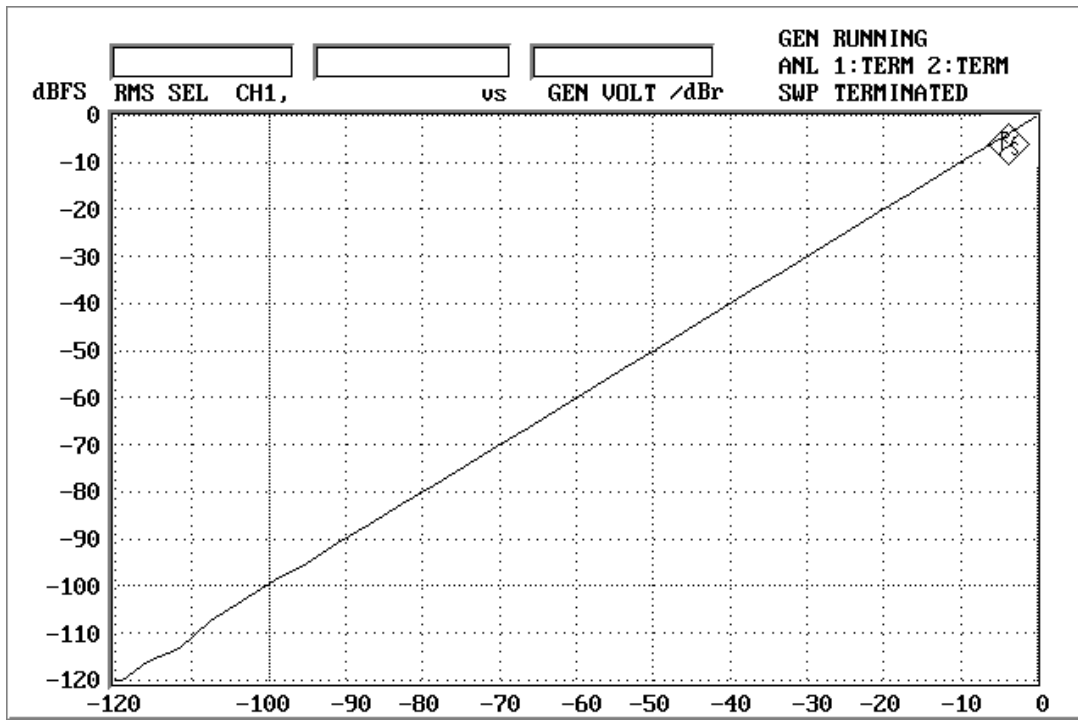

Figure 12. Linearity (fs=96kHz; fin=1kHz)

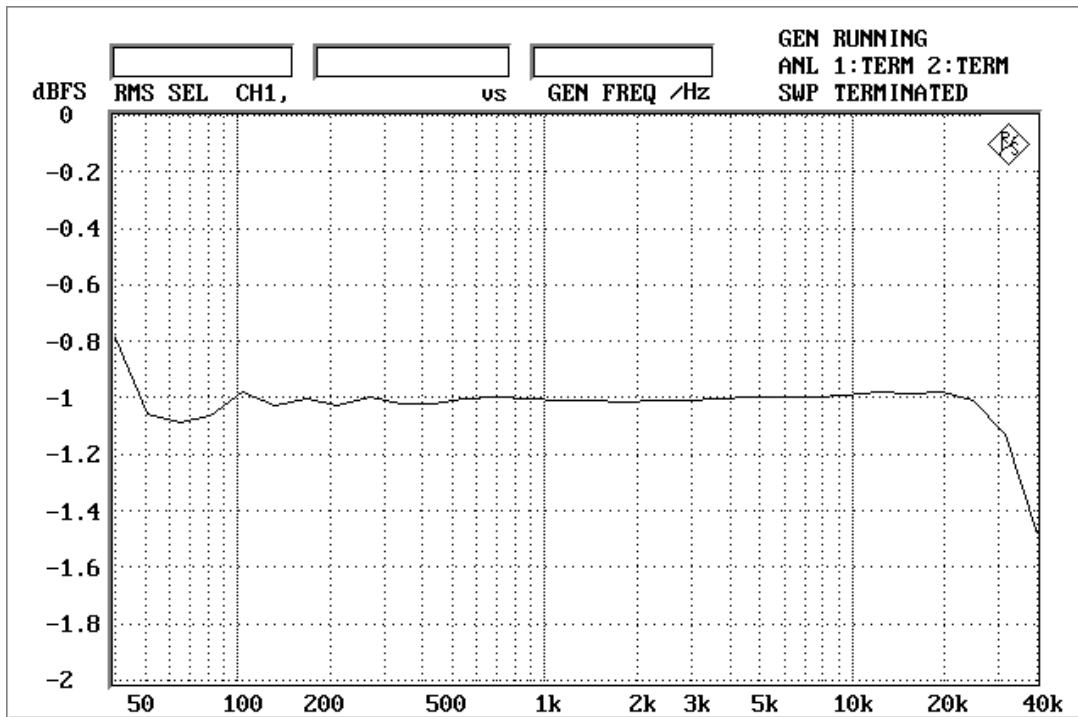
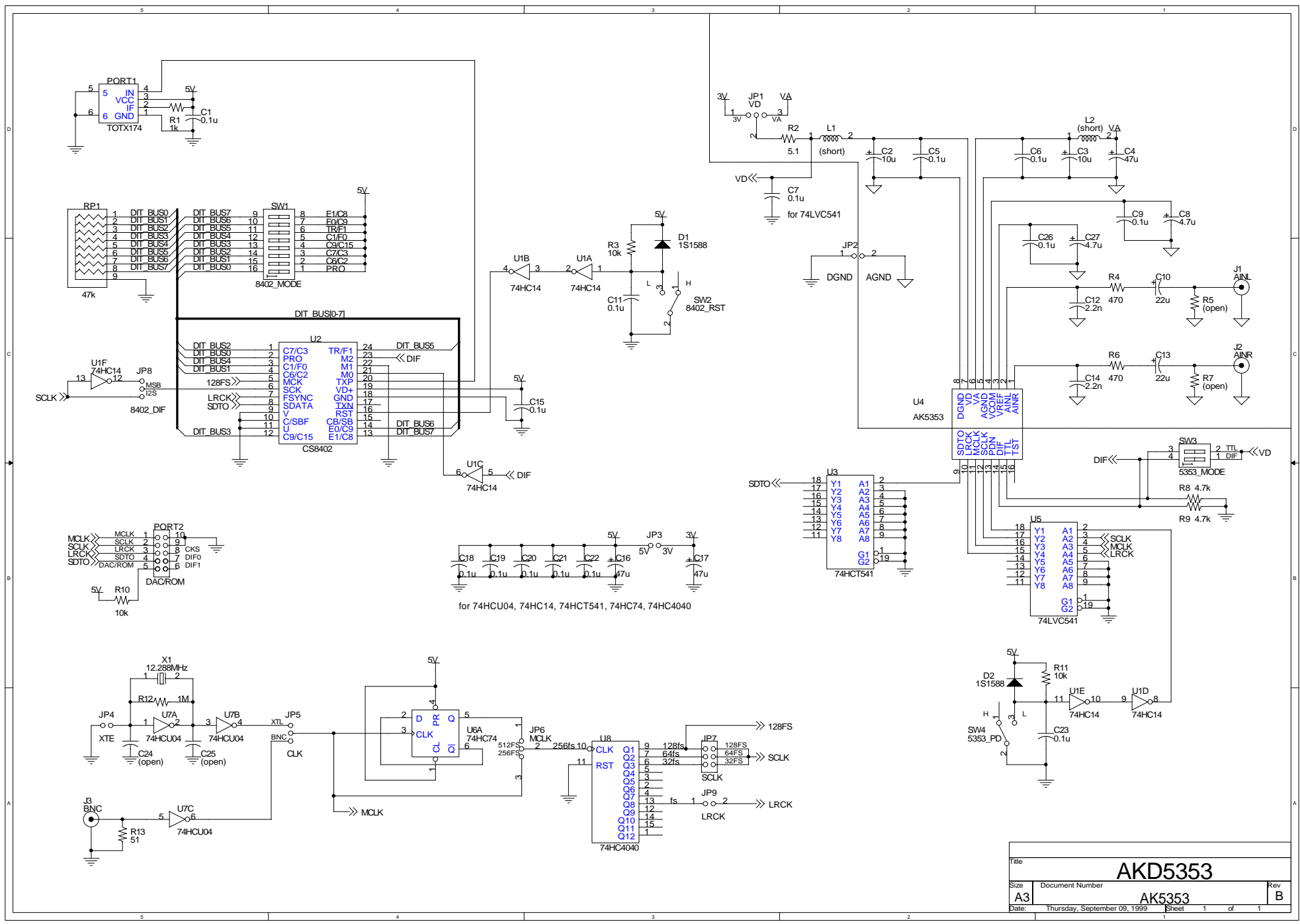
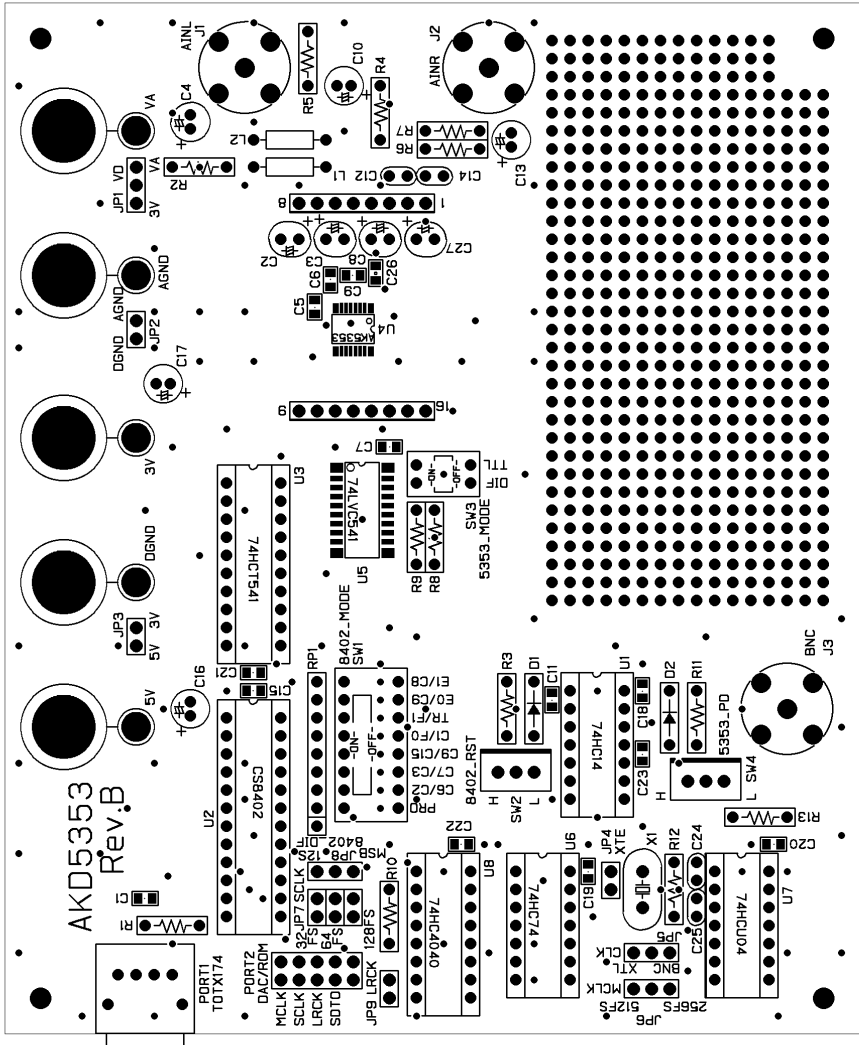

Figure 13. Frequency Response (fs=96kHz; Input Level=-1dBFS)
* including input RC filter (fc=154kHz) response



Title			AKD5353		
Size	Document Number				Rev
A3	AK5353				B
Date:	Thursday, September 09, 1999	Sheet	1	of	1



L1 部品面 レジスト シルク AKD5353 Rev.B

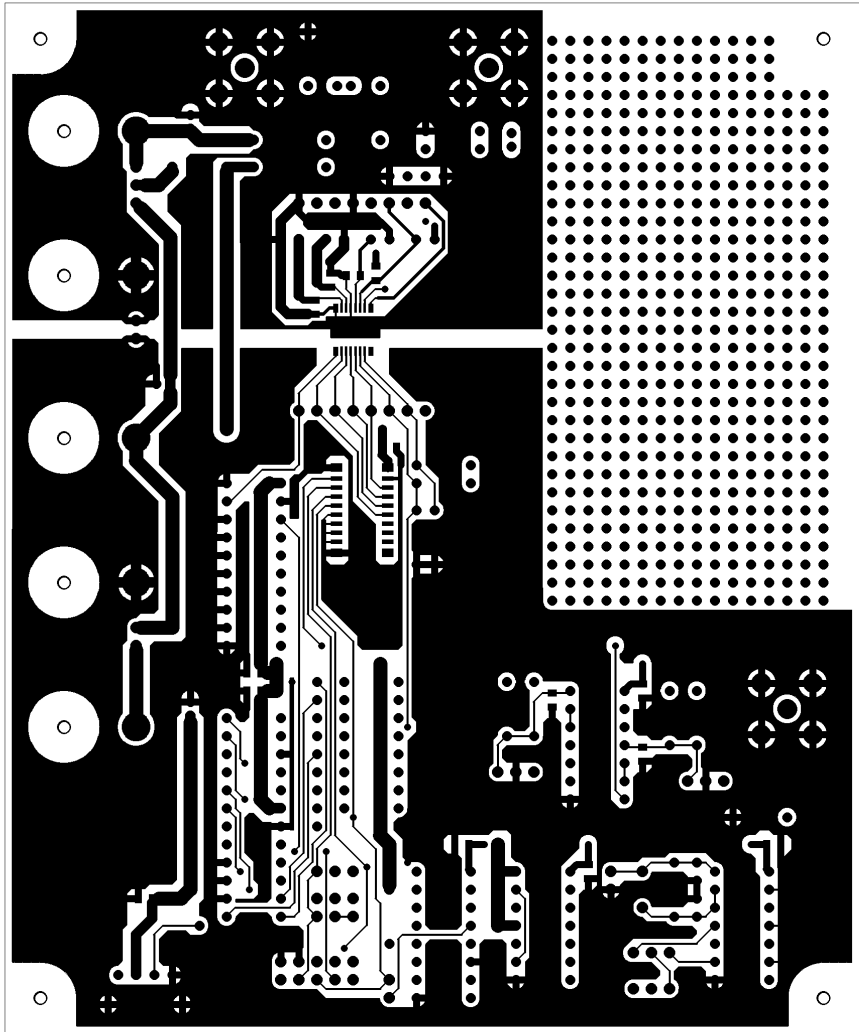

L1 部品面 パターン

AKD5353 Rev.B

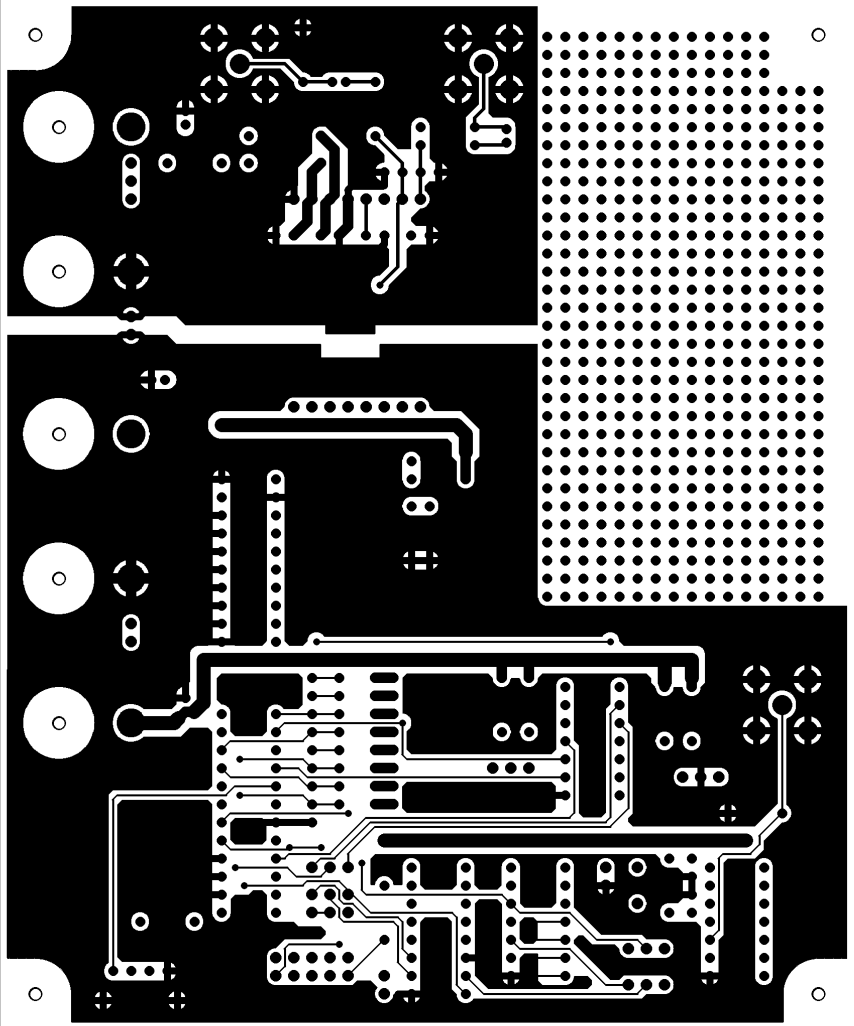

FS 板面 1A-2

VKD2323 Rev.B

IMPORTANT NOTICE

- These products and their specifications are subject to change without notice. Before considering any use or application, consult the Asahi Kasei Microsystems Co., Ltd. (AKM) sales office or authorized distributor concerning their current status.
- AKM assumes no liability for infringement of any patent, intellectual property, or other right in the application or use of any information contained herein.
- Any export of these products, or devices or systems containing them, may require an export license or other official approval under the law and regulations of the country of export pertaining to customs and tariffs, currency exchange, or strategic materials.
- AKM products are neither intended nor authorized for use as critical components in any safety, life support, or other hazard related device or system, and AKM assumes no responsibility relating to any such use, except with the express written consent of the Representative Director of AKM. As used here:
 - (a) A hazard related device or system is one designed or intended for life support or maintenance of safety or for applications in medicine, aerospace, nuclear energy, or other fields, in which its failure to function or perform may reasonably be expected to result in loss of life or in significant injury or damage to person or property.
 - (b) A critical component is one whose failure to function or perform may reasonably be expected to result, whether directly or indirectly, in the loss of the safety or effectiveness of the device or system containing it, and which must therefore meet very high standards of performance and reliability.
- It is the responsibility of the buyer or distributor of an AKM product who distributes, disposes of, or otherwise places the product with a third party to notify that party in advance of the above content and conditions, and the buyer or distributor agrees to assume any and all responsibility and liability for and hold AKM harmless from any and all claims arising from the use of said product in the absence of such notification.